

# CEA Standard

## A DTV Profile for Uncompressed High Speed Digital Interfaces

CEA-861-E

March 2008



**CEA**<sup>®</sup>  
Consumer Electronics Association

[www.CE.org](http://www.CE.org)

## NOTICE

Consumer Electronics Association (CEA<sup>®</sup>) Standards, Bulletins and other technical publications are designed to serve the public interest through eliminating misunderstandings between manufacturers and purchasers, facilitating interchangeability and improvement of products, and assisting the purchaser in selecting and obtaining with minimum delay the proper product for his particular need. Existence of such Standards, Bulletins and other technical publications shall not in any respect preclude any member or nonmember of CEA from manufacturing or selling products not conforming to such Standards, Bulletins or other technical publications, nor shall the existence of such Standards, Bulletins and other technical publications preclude their voluntary use by those other than CEA members, whether the standard is to be used either domestically or internationally.

Standards, Bulletins and other technical publications are adopted by CEA in accordance with the American National Standards Institute (ANSI) patent policy. By such action, CEA does not assume any liability to any patent owner, nor does it assume any obligation whatever to parties adopting the Standard, Bulletin or other technical publication.

This CEA Standard is considered to have International Standardization implication, but the International Electrotechnical Commission activity has not progressed to the point where a valid comparison between the CEA Standard and the IEC document can be made.

This Standard does not purport to address all safety problems associated with its use or all applicable regulatory requirements. It is the responsibility of the user of this Standard to establish appropriate safety and health practices and to determine the applicability of regulatory limitations before its use.

(Formulated under the cognizance of the CEA's **R4.8 DTV Interface Subcommittee**.)

Published by

©CONSUMER ELECTRONICS ASSOCIATION 2008  
Technology & Standards Department  
1919 S. Eads Street  
Arlington, Virginia 22202

**PRICE: Please call Information Handling Services, USA and Canada (1-800-854-7179)  
International (303-397-7956), or**

**<http://global.ihs.com>**

All rights reserved

Printed in U.S.A.

PLEASE!

DON'T VIOLATE  
THE  
LAW!

This document is copyrighted by the Consumer Electronics Association (CEA®)  
and may not be reproduced without permission.

Organizations may obtain permission to reproduce a limited number of copies by  
entering into a license agreement. For information contact:

Information Handling Services  
15 Inverness Way East  
Englewood, Colorado 80112-5704  
or call U.S.A. and Canada 1-800-854-7179, International (303) 397-7956  
See <http://global.ihs.com> or email [global@ihs.com](mailto:global@ihs.com)



# Contents

<b>1 Scope</b> .....	<b>1</b>
<b>2 General</b> .....	<b>1</b>
<b>2.1 References</b> .....	<b>1</b>
<b>2.1.1 Normative References</b> .....	<b>1</b>
2.1.1.1 Normative Reference List.....	1
2.1.1.2 Normative Reference Acquisition .....	3
<b>2.1.2 Informative References</b> .....	<b>3</b>
2.1.2.1 Informative Document List.....	4
2.1.2.2 Informative Document Acquisition .....	5
<b>2.2 Definitions</b> .....	<b>6</b>
<b>2.3 Symbols and Abbreviations</b> .....	<b>10</b>
<b>2.4 Compliance Notation</b> .....	<b>11</b>
<b>2.5 Hexidecimal Notation</b> .....	<b>11</b>
<b>2.6 HxV Video Timing Notation</b> .....	<b>11</b>
<b>2.7 Bit Naming Conventions</b> .....	<b>12</b>
<b>2.8 ASCII Codes, Characters &amp; Strings</b> .....	<b>12</b>
<b>3 Overview</b> .....	<b>12</b>
<b>3.1 General Video Format Requirements</b> .....	<b>13</b>
<b>4 Video Formats and Waveform Timings</b> .....	<b>14</b>
<b>4.1 Aspect Ratio</b> .....	<b>26</b>
<b>4.2 Frame Rate Relationships</b> .....	<b>29</b>
<b>5 Color Encoding, Sampling, &amp; Conversion</b> .....	<b>29</b>
<b>5.1 Default Encoding Parameters</b> .....	<b>29</b>
<b>5.2 Color Component Samples</b> .....	<b>30</b>
<b>5.2.1 RGB-to-YC<sub>B</sub>C<sub>R</sub> Conversion Matrices</b> .....	<b>30</b>
<b>5.2.2 Sample Lattice</b> .....	<b>30</b>
<b>5.3 Transfer Characteristic (e.g. gamma correction)</b> .....	<b>31</b>
<b>5.4 Color Coding &amp; Quantization</b> .....	<b>32</b>
<b>6—Auxiliary Information Carried from Source to Sink</b> .....	<b>32</b>
<b>6.1 Vendor Specific InfoFrames</b> .....	<b>33</b>
<b>6.2 Auxiliary Video Information (AVI) InfoFrame</b> .....	<b>34</b>
<b>6.3 Format of Version 1 AVI InfoFrame</b> .....	<b>35</b>
<b>6.4 Format of Version 2 AVI InfoFrame</b> .....	<b>35</b>
<b>6.5 Source Product Description (SPD) InfoFrame</b> .....	<b>46</b>
<b>6.6 Audio InfoFrame</b> .....	<b>47</b>
<b>6.6.1 Audio Identification Information</b> .....	<b>48</b>
<b>6.6.2 Speaker Mapping and Down-mix Information</b> .....	<b>50</b>
<b>6.7 MPEG Source InfoFrame</b> .....	<b>54</b>
<b>6.8 NTSC VBI InfoFrame</b> .....	<b>55</b>
<b>7 EDID Data Structure</b> .....	<b>55</b>
<b>7.1 Use of CEA Extensions</b> .....	<b>56</b>
<b>7.2 Describing Video Formats in EDID</b> .....	<b>57</b>
<b>7.2.1 Use of EDID Detailed Timing Descriptors</b> .....	<b>57</b>
<b>7.2.2 Order of Dual-Aspect Ratio Detailed Timing Descriptors</b> .....	<b>58</b>
<b>7.2.3 Source Requirements and Recommendations</b> .....	<b>59</b>
<b>7.3 CEA Extension Version 1</b> .....	<b>59</b>

7.4 CEA Extension Version 2.....	60
7.5 CEA Extension Version 3.....	61
7.5.1 Video Data Block.....	65
7.5.2 Audio Data Block.....	65
7.5.3 Speaker Allocation Data Block.....	66
7.5.4 Vendor Specific Data Block.....	67
7.5.5 Colorimetry Data Block.....	67
7.5.6 Video Capability Data Block.....	68
7.5.7 Vendor-Specific Video Data Block.....	70
7.5.8 Vendor-Specific Audio Data Block.....	70
<b>Annex A Baseline Example EDID and Detailed Timing Descriptors (Informative).....</b>	<b>72</b>
<b>A.1 Background.....</b>	<b>72</b>
<b>A.2 EDID Tables.....</b>	<b>72</b>
A.2.1 EDID Table Construction.....	72
A.2.2 Detailed Explanation of EDID Block Zero.....	73
A.2.3 Block Zero Header Section.....	73
A.2.4 Vendor / Product Identification.....	73
A.2.5 EDID Version.....	75
A.2.6 Basic Display Parameters and Features.....	75
A.2.7 Color Characteristics.....	78
A.2.8 Established Timings.....	79
A.2.9 Standard Timing ID #1 – 8.....	80
A.2.10 Detailed Timing Descriptor Block.....	80
A.2.10.1 First Detailed Timing Descriptor.....	80
A.2.10.2 Second Detailed Timing Descriptor.....	81
A.2.10.3 First Monitor Descriptor (Monitor Name).....	82
A.2.10.4 Second Monitor Descriptor (Monitor Range Limits).....	83
A.2.11 Extension Flag and Checksum.....	84
A.2.11.1 Block One Details.....	85
A.2.12 Overview of Extensions.....	85
A.2.13 Block One CEA Extension Header.....	86
A.2.14 Third Detailed Timing Descriptor.....	87
A.2.15 Fourth Detailed Timing Descriptor.....	87
A.2.16 Descriptor Defined by Manufacturer.....	88
A.2.17 Monitor Serial Number.....	89
A.2.18 Residual Byte Padding and Check Sum.....	89
A.2.19 Hot Plugging Sequence.....	91
<b>A.3 Complete Example EDID Table (Informative).....</b>	<b>92</b>
<b>A.4 Example EDID Detailed Timing Descriptors.....</b>	<b>99</b>
<b>Annex B Application to DVI 1.0 (Normative).....</b>	<b>111</b>
<b>B.1 Connector and Cable.....</b>	<b>111</b>
<b>B.2 Digital Content Protection.....</b>	<b>111</b>
<b>Annex C Application to Open LDI (Normative).....</b>	<b>112</b>
<b>C.1 Open LDI Data and Control Signals.....</b>	<b>112</b>
<b>C.2 Non DC Balanced Mode.....</b>	<b>112</b>
<b>C.3 OpenLDI Cabling Information.....</b>	<b>112</b>
C.3.1 Cable Length.....	113
C.3.2 Number of Signal Conductors.....	113
C.3.3 Wire Gauge.....	113
C.3.4 Conductor Resistance.....	113
C.3.5 Insulation.....	113
C.3.6 Shield Requirement.....	113
C.3.7 Single Twisted Pair Transmission Skew.....	113

C.3.8 Multiple Twisted Pair Transmission Skew.....	113
C.3.9 USB Cable Requirements.....	113
C.3.10 DDC Cable Requirements.....	113
<b>Annex D Application to HDMI (Informative) .....</b>	<b>114</b>
D.1 InfoPackets .....	114
D.2 EDID.....	114
D.3 Audio .....	114
D.4 HDCP .....	114
D.5 Additional Information.....	114
D.6 Example EDID Using Elements of CEA Block Tag Extension (Applicable to HDMI) .....	114
D.6.1 First Monitor Descriptor (Monitor Name) and Second Monitor Descriptor (Monitor Range Limits) .....	114
D.6.2 Extension Flag and Checksum .....	115
D.6.3 CEA Extension Header (Block 1).....	115
D.6.4 CEA Data Block Collection.....	115
D.6.5 Video Data Block.....	115
D.6.6 CEA Audio Block.....	116
D.6.7 Speaker Allocation Block.....	116
D.6.8 Vendor Specific Block.....	117
D.6.9 Complete CEA-861-E Example with Block Tag Extension.....	118
<b>Annex E [Reserved for Future Use] .....</b>	<b>127</b>
<b>Annex F Guidance for Source &amp; Sinks (Informative) .....</b>	<b>128</b>
F.1 Overview.....	128
F.2 Background.....	128
F.3 Guidance for Sources .....	128
F.3.1 Stable Video Format.....	129
F.3.2 Changing Video Format .....	129
F.3.3 Optional User Controlled Setting.....	131
F.3.4 Non-Default Scenarios .....	131
F.3.5 Errors Reading the EDID.....	132
F.4 Guidance for Sinks.....	132
F.4.1 Valid Read-Only EDID .....	133
F.4.2 Ordering of the Video Formats in the EDID .....	133
F.4.3 Video Information Code (VIC) Transition .....	133
<b>Annex G InfoPacket Framework (Informative).....</b>	<b>134</b>
<b>Annex H Active Format Description (Informative).....</b>	<b>135</b>
H.1 ATSC Active Format Description .....	135
H.2 DVB Active Format Description.....	137
<b>Annex I Picture Aspect Ratio Conversion Example (Informative) .....</b>	<b>140</b>
<b>Annex J [ Intentionally Omitted ].....</b>	<b>141</b>
<b>Annex K Audio Speaker Placement &amp; Channel Allocation Compatibility (Informative).....</b>	<b>142</b>
<b>Annex L Video Timing Examples (Informative).....</b>	<b>144</b>

## Figures

Figure 1. General Progressive Video Format Timing (Negative Sync).....	21
Figure 2. General Progressive Video Format Timing (Positive Sync).....	22
Figure 3 General Interlaced Video Format Timing (Negative Sync).....	23
Figure 4. General Interlaced Video Format Timing (Positive Sync).....	24
Figure 5 Special Interlaced Video Format Timing (Even Vtotal).....	25
Figure 6 Speaker Placement.....	51
Figure 7 OpenLDI Synchronization.....	112
Figure 8 Video Processing Chain.....	128
Figure 9 Example of Options for Format Conversion.....	130
Figure 10 Multiple Conversions Example.....	131
Figure 11. Active Format Illustration (ATSC).....	135
Figure 12 Active Format Illustration (DVB).....	138
Figure 13 Example of Problem Resulting from Double Stretch.....	140
Figure 14 General Progressive Example for Video ID Codes 2 & 3 (720x480p @ 60 Hz).....	144
Figure 15 General Interlace Example for Video ID Code 5 (1920x1080i @ 60 Hz).....	145
Figure 16 Special Interlace Example for Video ID Code 39 (1920x1080i-1250 Vtotal @ 50 Hz).....	146

## Tables

Table 1 Video Format Timings—Support Requirements and Recommendations.....	14
Table 2 Video Format Timings—Detailed Timing Information.....	16
Table 3 Video Format Timings—Detailed Sync Information.....	18
Table 4 Video Formats—Video ID Code and Aspect Ratios.....	27
Table 5 Frame Rate Relationships—Base to High Frame Rate VICs.....	29
Table 6 List of InfoFrame Type Codes.....	33
Table 7 Vendor Specific InfoFrame.....	34
Table 8 Auxiliary Video Information InfoFrame format (Version 1).....	35
Table 9 Auxiliary Video Information (AVI) InfoFrame Format (Version 2).....	36
Table 10 AVI InfoFrame Data Byte 1.....	37
Table 11 AVI InfoFrame Data Byte 2.....	38
Table 12 Common Active Formats.....	39
Table 13 AVI InfoFrame Data Byte 3.....	39
Table 14 Picture Colorimetry Indicated by the RGB or YC <sub>B</sub> C <sub>R</sub> (Y), Colorimetry (C) and Extended Colorimetry (EC) Field Settings.....	41
Table 15 AVI InfoFrame Pixel Repetition Field, Data Byte 5.....	41
Table 16 AVI Info Frame IT Contents Type, Data Byte 5.....	42
Table 17 AVI Info Frame YCC Quantization Range, Data Byte 5.....	43
Table 18 Valid Pixel Repeat Values for Each Video Format Timing.....	44
Table 19 Typical Gaming Format AVI InfoFrame Parameters.....	45
Table 20 Video Format Information (Informative).....	45
Table 21 Source Product Description InfoFrame Format.....	46
Table 22 Source Product Description InfoFrame Data Byte 25.....	47
Table 23 Audio InfoFrame Format.....	48
Table 24 Audio InfoFrame Data Byte 1.....	49
Table 25 Audio InfoFrame Data Byte 2.....	50
Table 26 Audio Format Code Extension (Data Byte 3).....	50
Table 27 Speaker Placement.....	51
Table 28 Audio InfoFrame Data Byte 4.....	53
Table 29 Audio InfoFrame Data Byte 5, Level Shift Value.....	53



Table 30 Audio InfoFrame Data Byte 5, Down-mix Inhibit Flag.....	53
Table 31 Audio InfoFrame Data Byte 5, LFE Playback Level Information.....	54
Table 32 MPEG Source InfoFrame format .....	54
Table 33 MPEG Source InfoFrame Data Byte 5.....	55
Table 34 NTSC VBI InfoFrame.....	55
Table 35 Video Timing Code 39 Detailed Timing Descriptor .....	58
Table 36 CEA Extension Version 1.....	60
Table 37 CEA Extension Version 2.....	61
Table 38 CEA Extension Version 3.....	62
Table 39 General Format of “CEA Data Block Collection” .....	63
Table 40 Data Block Header Byte .....	64
Table 41 CEA Data Block Tag Codes .....	64
Table 42 Extended Tag Format (2 <sup>nd</sup> Byte of Data Block).....	64
Table 43 CEA Data Block Tag Codes .....	64
Table 44 Short Video Descriptor .....	65
Table 45 CEA Short Audio Descriptor for Audio Format Code = 1 (LPCM) .....	66
Table 46 CEA Short Audio Descriptor for Audio Format Codes 2 to 8 .....	66
Table 47 CEA Short Audio Descriptor for Audio Format Codes 9 to 13 .....	66
Table 48 CEA Short Audio Descriptor for Audio Format Code 14 (WMA Pro) .....	66
Table 49 CEA Short Audio Descriptor for Audio Format Code 15 (extension).....	66
Table 50 Speaker Allocation Data Block Payload.....	67
Table 51 Colorimetry Data Block.....	67
Table 52 Data Byte 3 Colorimetry Support Flags .....	67
Table 53 Data Byte 4 Colorimetry Metadata Support Flags.....	68
Table 54 Video Capability Data Block (VCDB) .....	68
Table 55 Video Capability Descriptor Data Byte 3.....	68
Table 56 Vendor-Specific Video Data Block (VSVDB).....	70
Table 57 Vendor-Specific Audio Data Block (VSADB) .....	71
Table 58 Standard Data Lengths .....	73
Table 59 Block Zero Header .....	73
Table 60 Vendor / Product Identification; Showing Manufacturer Week and year.....	75
Table 61 Vendor / Product Identification .....	75
Table 62 Example 0x15, 0x16 EDID Screen Size Data and Certain Display Categories .....	76
Table 63 Feature Support Detail .....	77
Table 64 Basic Display Parameters and Features Block .....	78
Table 65 Binary to Decimal Conversion Example .....	78
Table 66 Color Characteristics Block .....	79
Table 67 Established Timings Block.....	79
Table 68 Standard Timing ID Block.....	80
Table 69 First Detailed Timing Descriptor Block (1920x1080i Example).....	81
Table 70 Second Detailed Timing Descriptor Block (720x480p, 4:3 Example).....	82
Table 71 First Monitor Descriptor Block (Monitor Name) .....	83
Table 72 Second Monitor Descriptor Block (Monitor Range Limits) .....	84
Table 73 Extension Flag Block .....	85
Table 74 Block One CEA Extension Header.....	86
Table 75 Third Detailed Timing Descriptor Block (720p, 16:9 Example) .....	87
Table 76 Fourth Detailed Timing Descriptor Block (480i, 4:3 Example).....	88
Table 77 Descriptor Defined by Manufacturer Block .....	89
Table 78 Monitor Serial Number Block .....	89
Table 79 Residual Byte Stuffing and Check Sum Block .....	90
Table 80 Complete EDID Example.....	92
Table 81 Example EDID Detailed Timing Descriptor for 1280x720p (60 Hz, 16:9).....	99
Table 82 Example EDID Detailed Timing Descriptor for 1920x1080i (60 Hz, 16:9) .....	100
Table 83 Example EDID Detailed Timing Descriptor for 720x480p (59.94 Hz, 4:3).....	101
Table 84 Example EDID Detailed Timing Descriptor for 720x480p (59.94Hz, 16:9).....	102
Table 85 Example EDID Detailed Timing Descriptor for 720x480i (59.94Hz, 4:3).....	103

Table 86 Example EDID Detailed Timing Descriptor for 720x480i (59.94Hz, 16:9) .....	104
Table 87 Example EDID Detailed Timing Descriptor for 1280x720p (50 Hz, 16:9).....	105
Table 88 Example EDID Detailed Timing Descriptor for 1920x1080i (50 Hz, 16:9) .....	106
Table 89 Example EDID Detailed Timing Descriptor for 720x576p (50 Hz, 4:3).....	107
Table 90 Example EDID Detailed Timing Descriptor for 720x576p (50 Hz, 16:9).....	108
Table 91 Example EDID Detailed Timing Descriptor for 720x576i (50 Hz, 4:3) .....	109
Table 92 Example EDID Detailed Timing Descriptor for 720x576i (50 Hz, 16:9) .....	110
Table 93 OpenLDI Control Signals .....	112
Table 94 CEA Extension Header (Block 1) .....	115
Table 95 Video Data Block .....	116
Table 96 Audio Data Block.....	116
Table 97 Speaker Data Block .....	117
Table 98 Vendor Specific Data Block.....	117
Table 99 CEA-861-E EDID Example with Block Tag Extension .....	118
Table 100 Illustrated ATSC AFD Coding.....	137
Table 101 Illustrated DVB AFD Coding .....	139
Table 102 SMPTE/CEA Audio Channel Description & Abbreviation Comparison .....	142
Table 103 SMPTE/CEA Audio Channel Assignment Comparison .....	143

## FOREWORD

This standard was developed under the auspices of the Consumer Electronics Association (CEA) R4.8 DTV Interface Subcommittee.

CEA-861-E supersedes CEA-861-D.

(This page intentionally left blank.)

# A DTV Profile for Uncompressed High Speed Digital Interfaces

## 1 Scope

CEA-861-E establishes protocols, requirements, and recommendations for the utilization of uncompressed digital interfaces by consumer electronics devices such as digital televisions (DTVs), digital cable, satellite or terrestrial set-top boxes (STBs), and related peripheral devices including, but not limited to DVD players/recorders, and other related sources or sinks.

CEA-861-E is applicable to a variety of standard DTV-related high-speed digital physical interfaces - such as Digital Visual Interface (DVI) 1.0 [4], Open LVDS Display Interface (LDI) [8], and High-Definition Multimedia Interface (HDMI) [50] specifications. Protocols, requirements, and recommendations that are defined include video formats and waveforms; colorimetry and quantization; transport of compressed and uncompressed, as well as Linear Pulse Code Modulation (LPCM), audio; carriage of auxiliary data; and implementations of the Video Electronics Standards Association (VESA) *Enhanced Extended Display Identification Data Standard* (E-EDID) [10], which is used by sinks to declare display capabilities and characteristics.

CEA-861-E adopters are strongly encouraged to implement High-bandwidth Digital Content Protection (HDCP) [3] content protection, defined by the Digital Content Protection, LLC (DCP) method, in order to be compatible with digital cable STBs as authorized by 47 C.F.R. § 76.602 [48] and 47 C.F.R. §76.640 [49]. HDCP [3] permits viewing of high-value content that may be available from other video sources in a home network.

## 2 General

### 2.1 References

CEA-861-E includes mechanisms that allow a digital video source (such as a cable, satellite or terrestrial STB, digital VCR, or DVD player) to supply displayable, baseband, digital video to High Definition Television (HDTV) and Enhanced Definition Television (EDTV) devices, as well as peripheral devices such as repeaters, switchers, and recorders, as defined in *CEA Expands Definitions for Digital Television Products* [43].

#### 2.1.1 Normative References

The following standards contain provisions that, through reference in this text, constitute normative provisions of this standard. At the time of publication, the editions indicated were valid. All standards are subject to revision, and parties to agreements based on this standard are encouraged to investigate the possibility of applying the most recent editions of the standards listed in Sec. 2.1.1.1. If the referenced standard is dated, the reader is advised to use the version specified.

##### 2.1.1.1 Normative Reference List

1. SMPTE 170M (2004), Composite Analog Video Signal—NTSC for Studio Applications
2. SMPTE 274M (2005), SMPTE Standard for Television—1920x1080 Image Sample Structure, Digital Representation and Digital Timing Reference Sequences for Multiple-Picture Rates
3. DCP, L.L.C., HDCP Specification, Revision 1.1, June 9, 2003
4. DDWG, Digital Visual Interface, Revision 1.0, April 2, 1999
5. IEC 61966-2-4: Multimedia systems and equipment - Colour measurement and management - Part 4: Colour management - Extended-gamut YCC colour space for video applications, January 2006
6. ITU-R BT.601-5, Studio Encoding parameters of digital television for standard 4:3 and wide-screen 16:9 aspect ratios, 1995
7. ITU-R BT.709-5, Parameter Values for the HDTV standards for production and International Programme Exchange, 2002
8. Open LVDS Display Interface (Open LDI) Specification, Version 0.95, May 13, 1999
9. VESA E-DDC™ Standard, VESA Enhanced Display Data Channel Standard, Version 1.1, March 24, 2004
10. VESA E-EDID™ Standard, VESA Enhanced Extended Display Identification Data Standard, Release A, Revision 1, February 9, 2000 --- Defines EDID Structure Version 1, Revision 3

11. VESA DDC/CI Standard, VESA Display Data Channel Command Interface (DDC/CI) Standard, Version 1.1, October 29, 2004
12. ATSC Standard A/52B, Digital Audio Compression Standard (AC-3, E-AC-3) Revision B, June 14, 2005
13. IEC 60958-3 Digital Audio Interface - Part 3: Consumer Applications, First Edition, 1999
14. IEC 61909, Audio recording - Minidisc system
15. IEC 61937-3:2007 Digital audio - Interface for non-linear PCM encoded audio bitstreams applying IEC 60958 - Part 3: Non-linear PCM bitstreams according to the AC-3 and enhanced AC-3 formats
16. IEC 61937-4:2003 Digital audio - Interface for non-linear PCM encoded audio bitstreams applying IEC 60958 - Part 4: Non-linear PCM bitstreams according to the MPEG audio formats
17. IEC 61937-5:2006, Digital audio - Interface for non-linear PCM encoded audio bitstreams applying IEC 60958 - Part 5: Non-linear PCM bitstreams according to the DTS (Digital Theater Systems) format(s)
18. IEC 61937-6:2006 Digital audio - Interface for non-linear PCM encoded audio bitstreams applying IEC 60958 - Part 6: Non-linear PCM bitstreams according to the MPEG-2 AAC and MPEG-4 AAC audio formats
19. IEC 61937-7:2004, Digital audio - Interface for non-linear PCM encoded audio bitstreams applying IEC 60958 - Part 7: Non-linear PCM bitstreams according to the ATRAC, ATRAC2/3 and ATRAC-X formats
20. IEC 61937-8:2006, Digital audio - Interface for non-linear PCM encoded audio bitstreams applying IEC 60958 - Part 8: Non-linear PCM bitstreams according to the Windows Media Audio (WMA) Professional format
21. IEC 61937-9:2007 Digital audio - Interface for non-linear PCM encoded audio bitstreams applying IEC 60958 - Part 9: Non-linear PCM bitstreams according to the MAT format
22. ISO/IEC 11172-3:1993, Information Technology - Coding of moving pictures and associated audio for digital storage media at up to about 1.5 Mbit/sec, Part 3: Audio, 1993
23. ISO/IEC 13818-3, Information Technology - Generic coding of moving pictures and associated audio information, Part 3: Audio, Second Edition, 1998-04-15
24. ISO/IEC 14496-3:2005, Information Technology - Coding of audio-visual objects - Part 3: Audio
25. ISO/IEC 14496-3:2005/AMD2:2006, Information Technology - Coding of audio-visual objects - Part 3: Audio, Amendment 2: Audio Lossless Coding (ALS), new audio profiles and BSAC extensions
26. ISO/IEC 23003-1:2007 Information technology -- MPEG audio technologies -- Part 1: MPEG Surround
27. DVD Forum, DVD Specifications for Read-Only Disc, Part 4, Audio Specifications, Version 1.0, Meridian Lossless Packing
28. DVD Forum, DVD Specifications for High Definition Video, Version 1.0, DTS-HD Reference Information
29. SCTE 127:2007, Carriage of Vertical Blanking Interval (VBI) Data in North American Digital Television Bitstreams
30. Microsoft, WMA Pro Decoder Specification: An Overview of Windows Media Audio Professional decoder
31. CEA-770.2-D, Standard Definition TV Analog Component Video Interface, April 2007
32. CEA-770.3-C, High Definition TV Analog Component Video Interface, August 2001
33. IEC 61966-2-5, Multimedia systems and equipment - Colour measurement and management - Part 2-5: Colour management - Optional RGB colour space - opRGB
34. IEC 61966-2-1:1999, Multimedia systems and equipment - Colour measurement and management - Part 2-1: Colour management - Default RGB colour space - sRGB
35. IEC 61966-2-1/Amendment 1:2003 Multimedia systems and equipment - Colour measurement and management - Part 2-1: Colour management - Default RGB colour space - sRGB
36. SMPTE 2016-1 (2007) Television - Format for Active Format Description and Bar Data
37. ETSI 102 114 v1.1.1, DTS Coherence Acoustics; Core and Extensions, 2002-08
38. ANSI INCITS 4-1986 (R2002) Coded Character Sets - 7-Bit American National Standard Code for Information Interchange (7-Bit ASCII), Table 8

### 2.1.1.2 Normative Reference Acquisition

#### ANSI/CEA Standards

- Global Engineering Documents, World Headquarters, 15 Inverness Way East, Englewood, CO USA 80112-5776; Phone 800-854-7179; Fax 303-397-2740; Internet [global.ihs.com](http://global.ihs.com); Email [global@ihs.com](mailto:global@ihs.com)

#### ANSI/SMPTE Standards

- Society of Motion Picture and Television Engineers, 595 W. Hartsdale Avenue, White Plains, NY 10607-1824; Phone 914-761-1100; Fax 914-761-3115; Internet <http://www.smpte.org>

#### DDWG

- Contact Digital Display Working Group (DDWG); Attn: DDWG Administrator; M/S JF3-361; 2111 NE 25th Avenue, Hillsboro, OR 97124-5961, USA; Fax: 503-264-5959; Internet <http://www.ddwg.org>; Email [ddwg.if@intel.com](mailto:ddwg.if@intel.com)

#### DTS

- DTS, Inc., 5171 Clareton Drive, Agoura Hills, CA 91301, USA; Phone 818-706-3525; Fax 818-706-1868; Internet <http://www.dts.com/contact/dts-headquarters.php>

#### DVD Forum

- Office of Secretary, DVD FORUM, Daimon Urbanist Bldg. 6F, 2-3-6 Shibadaimon, Minato-ku, Tokyo 105-0012, Japan ; Phone +81 35 777 2881; Fax +81 35 777 2882; Internet <http://www.dvdforum.org>

#### HDCP

- Digital Content Protection, L.L.C., c/o Intel Corporation, Stephen Balogh, JF2-55; 2111 NE 25th Ave; Hillsboro, OR 97124; Email [info@digital-cp.com](mailto:info@digital-cp.com); Internet <http://www.digital-cp.com/home> or [www.digital-cp.com](http://www.digital-cp.com)

#### ITU Standards

- International Telecommunications Union, Place des Nations, CH-1211 Geneva 20, Switzerland; Phone +41 22 730 5111; Fax +41 22 733 7256; Internet <http://www.itu.int/publications/default.aspx>; Email [itumail@itu.int](mailto:itumail@itu.int);

#### Microsoft Windows Media Licensing Program

- Microsoft Windows Media Licensing Program, 1, Microsoft Way, Redmond, WA 98052, USA; Internet <http://www.microsoft.com/windows/windowsmedia/licensing/default.mspx>; Email [wmla@microsoft.com](mailto:wmla@microsoft.com)

#### OpenLDI

- Contact National Semiconductor: Internet <http://www.national.com/appinfo/fpd>

#### VESA Standards

- Contact Video Electronics Standards Association, 860 Hillview Court, Suite 150, Milpitas, CA 95035, USA; Phone 408-957-9270; Internet <http://www.vesa.org>

### 2.1.2 Informative References

The following documents contain information that is useful in understanding this standard. At the time of publication, the editions indicated were valid. All documents are subject to revision, and parties to agreements based on this standard are encouraged to investigate the possibility of applying the most recent editions of the documents listed in Section 2.1.2.1. Some of these documents are drafts of standards that may become normative references in a future release of this standard.

**2.1.2.1 Informative Document List**

39. SMPTE Standard 293M (2003), SMPTE Standard for Television—720x483 Active Line at 59.94 Hz Progressive Scan Production—Digital Representation
40. SMPTE 296M (2006), Standard for Television—1280x720 Scanning, Analog and Digital Representation and Analog Interface
41. SMPTE 125M (1995), Television - Component Video Signal 4:2:2 - Bit-Parallel Digital Interface
42. SMPTE 320M (1999), Television - Channel Assignments and Levels on Multichannel Audio Media
43. CEA Press Release; CEA Expands Definitions for Digital Television Products; August 31, 2000
44. CEA-608-D, Line 21 Data Service, May 2007
45. CEA-708-C, Digital Television (DTV) Closed Captioning, July, 2006
46. CEA-CEB16, Automatic Format Description (AFD) and Bar Data, July, 2006
47. ETSI TS 101 154 v1.7.1, Digital Video Broadcasting (DVB); Implementation guidelines for the use of Video and Audio Coding in Broadcasting Applications based on the MPEG-2 Transport Stream (Annex B), June 14, 2005
48. FCC Regulations, Part 76, Cable Television Service, 47 C.F.R. §76.602
49. FCC Regulations, Part 76, Cable Television Service, 47 C.F.R. §76.640
50. HDMI, High-Definition Multimedia Interface Specification, Version 1.3a, November 10, 2006
51. IEC 60958-1 Digital Audio Interface - Part 1: General, First Edition, 1999
52. ISO/IEC 13818-2:2000, Information technology -- Generic coding of moving pictures and associated audio information: Video
53. ITU-R BT.470–6, Conventional Television Systems, 1998
54. ITU-R BT.656–4, Interfaces for Digital Component Video Signals in 525-line and 625-line Television Systems Operating at the 4:2:2 Level of Recommendation, 1998
55. ITU-R BT.711–1, Synchronizing Reference Signals for the Component Digital Studio, 1992
56. ITU-R BT.1358, Studio Parameters of 625 and 525 Line Progressive Scan Television Systems, 1998
57. VESA Coordinated Video Timings (CVT), Version 1.1, September 10, 2003
58. VESA DI-EXT, Display Information Extension Block (DI-EXT™) for E-EDID, Release A, August 21, 2001
59. VESA E-EDID™ Implementation Guide, VESA Enhanced Extended Display Identification Data— Implementation Guide, Version 1.0, June 4, 2001--- Provides support for VESA E-EDID™ Standard, VESA Enhanced Extended Display Identification Data Standard, Release A, Revision 1, February 9, 2000
60. VESA GTF Standard, VESA Generalized Timing Formula Standard, Version 1.1, September 2, 1999.
61. ATRAC Audio Format Specifications for CEA-861
62. VESA Coordinated Video Timing Generator, Revision 1.1, April 9, 2003
63. VESA E-EDID™ Verification Guide, VESA Enhanced Extended Display Identification Data Verification Guide, Release A, March 27, 2007 --- Provides support for VESA E-EDID™ Standard, VESA Enhanced Extended Display Identification Data Standard, Release A, Revision 2, September 25, 2006
64. VESA GTF Spreadsheet, "VESA Generalized Timing Formula (GTF) Spreadsheet, Version 1, Revision 1.0, January 5, 1997
65. VESA Monitor Timing Specifications, VESA and Industry Standards and Guidelines for Computer Display Monitor Timing (DMT), Version 1.0, Revision 11, Adoption Date: May 1, 2007
66. VESA VTB-EXT, VESA Video Timing Block Extension Data Standard, Release A, November 24, 2003
67. AS 4933.1-2005, Digital television - Requirements for receivers - Part 1: VHF/UHF DVB-T television broadcasts, May 3, 2005
68. Adobe RGB (1998) Color Image Encoding, Version 2005-05, May 2005, Adobe Systems Incorporated. (<http://www.adobe.com/digitalimag/adobergb.html>)
69. Microsoft Plug and Play ID - PNPID Request Email [pnpid@microsoft.com](mailto:pnpid@microsoft.com); Internet: <http://www.microsoft.com/whdc/system/pnppwr/pnp/pnpid.msp>
70. Royal Philips Electronics and Sony Corporation, Super Audio CD System Description, Version 2.0
71. IEEE Registration Authority
72. IEC 61937-2:2007, Interface for non-linear PCM encoded audio bitstreams applying IEC 60958 - Part 2: Burst-info



### 2.1.2.2 Informative Document Acquisition

#### AS

- SAI Global Limited, Business Publishing, GPO Box 5420, Sydney NSW 2001. Phone +61 2 8206 6010; Fax +61 28 206 6020; Internet <http://www.saiglobal.com/shop>

#### CEA Standards

- Global Engineering Documents, World Headquarters, 15 Inverness Way East, Englewood, CO USA 80112-5776; Phone 800-854-7179; Fax 303-397-2740; Internet [global.ihs.com](http://global.ihs.com); Email [global@ihs.com](mailto:global@ihs.com)

#### ETSI

- European Telecommunications Standards Institute, 650, route des Lucioles, 06921 Sophia-Antipolis Cedex, France; Phone +33 (0)4 92 94 42 00; Fax +33 (0)4 93 65 47 16; Internet <http://www.etsi.org>

#### FCC

- FCC Regulations, U.S. Government Printing Office, Washington, D.C. 20401; Internet <http://www.access.gpo.gov/cgi-bin/cfrassemble.cgi?title=199847>

#### HDMI

- HDMI Licensing, LLC, 1060 E. Arques Avenue, Suite 100, Sunnyvale, CA 94085; Internet <http://www.hdmi.org>

#### IEEE Registraton Authority

- Institute of Electrical and Electronic Engineers, Inc., IEEE Registration Authority c/o IEEE Standards Association, 445 Hoes Lane, Piscataway, NJ 08855-1331; Internet <http://standards.ieee.org/regauth/oui/index.shtml>

#### ITU Standards

- International Telecommunications Union, Place des Nations, CH-1211 Geneva 20, Switzerland; Phone +41 22 730 5111; Fax +41 22 733 7256; Internet [http:// www.itu.int/publications/default.aspx](http://www.itu.int/publications/default.aspx); Email [itumail@itu.int](mailto:itumail@itu.int)

#### Philips

- Philips Intellectual Property & Standards; Building WAH, P.O. Box 220, 5600 AE Eindhoven, The Netherlands; Fax +31-40-2732113; Internet [www.licensing.philips.com](http://www.licensing.philips.com)

#### SMPTE Standards

- Society of Motion Picture & Television Engineers (SMPTE), 595 West Hartsdale Avenue, White Plains, NY 10607; Phone 914-761-1100; Fax 914-761-3115; Internet [www.smpte.org](http://www.smpte.org); Email [smpte@smpte.org](mailto:smpte@smpte.org)

Sony

- ATRAC Audio Format Specifications for CEA-861 Sony Corporation Head Office, 1-7-1 Konan, Minato-ku, Tokyo, 108-0075, Japan; Email [atrac-cea@jp.sony.com](mailto:atrac-cea@jp.sony.com)

VESA Standards

- Contact Video Electronics Standards Association, 860 Hillview Court, Suite 150, Milpitas, CA 95035, USA; Phone 408-957-9270; Internet <http://www.vesa.org>

## 2.2 Definitions

For the purposes of CEA-861-E, the following definitions apply.

**Active Format Description (AFD)**—A data structure that describes what portion of the picture actually contains useful information (e.g. letterbox and pillarbox bars are not considered useful information). Its 4-bit field is standardized in ETSI TS 101 154 [47], but whose exact meaning may depend on whether the data is delivered per ATSC/SCTE or ETSI standard. See Section 6.4 for details. Note that the use of the term “active” in this definition is not consistent with the use of this term in other portions of CEA-861-E and most of the other documents referenced by CEA-861-E.

**Active Image**—The useful image contained in a Picture. Active image excludes Bars.

**Active Line**—A video line occurring during the Vactive period(s) containing both blank and active pixels. Active and blank pixels fill the Hactive and Hblank portions of these lines, respectively.

**Active Pixel**—A video pixel that conveys pixel data.

**Adobe<sub>RGB</sub>**—The optional RGB (opRGB) color space defined in IEC 61966-2-5 [33]. See also the Adobe RGB (1998) Color Image Encoding Specification [68].

**Adobe<sub>YCC601</sub>**—The luma-chroma-chroma (YCC) color space defined in Annex A of IEC 61966-2-5 [33]. The ITU-R Rec. BT.601 [6] color conversion matrix is used to transform RGB values to YCC values.

**Auxiliary Video Information (AVI)**—Additional information (defined in CEA-861-E) related to the video being sent from a source to a sink.

**A/V**—Audio and Video.

**Bar Data**—Information that defines the location of Bars within a Picture.

**Bar Pixel** - An active pixel that conveys a portion of a bar.

**Bars**—Region of the display screen that is being driven or scanned at either zero luminance or at a uniform luminance; or regions of a picture that are intended to be driven (e.g., matrix addressed) or scanned (e.g., cathode ray tube (CRT)) at either zero luminance or at a uniform luminance. In other words, it is the portion of the picture that does not contain useful information.

**Basic Audio**—Uncompressed, two channel, digital audio. Exact parameters are determined by the interface specification used with CEA-861-E (e.g., 2 channel IEC 60958-3 [13] LPCM, 32, 44.1, and 48 kHz sampling rates, 16 bits/sample).

**Blank Pixel**—A video pixel that carries data other than pixel data.

**Blanking Line**—A video line occurring during Vblank period(s) containing only blank pixels. Blank pixels fill both Hactive and Hblank portions of these lines.

**Byte**—8 bits of data.

**CE Video Format**—Any video format listed in Table 2 except the 640x480p video format.

**CEA Extension**—The E-EDID Standard [10] defines a VESA-assigned tag (0x02) that allows for an extension to be added with additional timing formats.

**Coded Frame** - A horizontal by vertical array of coded pixels output by a video acquisition function (e.g., a decompressor or a camera aperture). When the source transmits  $Y C_B C_R$  pixel data the luma component samples of a coded frame have a one-to-one correlation to the luma component samples of a transmitted picture provided that the source does not transform the coded frame (i.e., up-/down-scale or frame-rate convert) or add bars to the coded frame prior to transmission. In this case, the luma component sample of each coded pixel in the coded frame has a one to one correlation with the luma component sample of each unique active pixel in the transmitted picture.

**Coded Line** - A horizontal line of coded pixels output by a video acquisition function (e.g., a decompressor or a camera aperture).

**Coded Pixel** - The colored component samples of a single picture element output by a video acquisition function (e.g. decompressor or a camera aperture).

**Color Component Sample**—A value that conveys information about a portion of a picture element. A color component sample may be a red sample (R), green sample (G), blue sample (B), a luma sample (Y) or chroma sample (C).

**Component Depth**—The number of bits used to represent a color component sample. It is generally denoted as N.

**Compressed Audio**—All audio formats other than LPCM and One Bit Audio.

**Content Pixel** - An active pixel that conveys a portion of the active image.

**Digital Television (DTV)**—A device that receives, decodes, and presents audio and video material that has been transmitted in a compressed form. The device can be a single unit or it can be constructed from a number of individual components (e.g. a digital terrestrial STB and an analog television).

**Direct Stream Digital (DSD)**— An uncompressed One Bit Audio format.

**Direct Stream Transfer (DST)**— A lossless compression scheme for the Direct Stream Digital audio format.

**DTV**—Defined in CEA-861-E to be an EDTV, HDTV, or SDTV. A sink can also be any combination of these terms. A DTV with an uncompressed video input is also considered a sink.

**Dual Aspect Ratio DTV**—A DTV that simultaneously supports both picture aspect ratios of a video format timing (e.g., 720x480p). Simultaneous support is signified by listing both formats in the EDID data structure at the same time.

**Dual Aspect Ratio Timing**—A video format timing (e.g., 720x480p) that is available in both picture aspect ratios (16:9 and 4:3) with no difference in the timing for the two formats.

**EDTV**—A DTV capable of displaying 720x480p in 16:9 or 4:3 picture aspect ratios. See Section 3.1 and Table 1.

**Full Quantization Range**—R, G, B or Y quantization range that includes all code values. See Section 5.4.

**HDTV**—A DTV capable of displaying 1920x1080i or 1280x720p format in the 16:9 picture aspect ratio. An HDTV also has EDTV capabilities. See Section 3.1 and Table 1.

**High Definition (HD)**—A CE video format that, inclusively, has between 720 to 1080 active vertical lines (Vactive) lines per video frame.

**InfoFrame**—A data transfer structure for sending miscellaneous information from a source to a sink over a CEA-861-E interface. Various InfoFrames are described in Section 6.

**IRE Unit** – A percentage of reference white with respect to black (i.e., blanking level). Reference white is assigned a value of 100, blanking a value of 0.

**IT Video Format**—Any video format that is not a CE video format. Specifically, any video format not listed in Table 2 plus the 640x480p video format.

**Limited Quantization Range**—R, G, B or Y quantization range that excludes some code values at the extremes. See Section 5.4.

**Multi-channel Audio**—Digital audio with more than two channels, for example, LPCM or AC-3.

**Native Display Device Aspect Ratio**—Ratio of maximum width to height dimension of the addressable portion of a physical display device screen, which is indicated in the EDID version 1, revision 3 block's "Max Horizontal Image Size" and "Max Vertical Image Size" fields.

**Native Format**—A video format with native pixel layout and scanning method that the display device accepts and displays without any internal scaling, de-interlacing, interlacing or frame rate conversion.

**Native Pixel Layout**—The exact number of horizontal pixels and vertical lines (or pixel mapping) that matches the physical structure of the display device.

**One Bit Audio**—1-bit Sigma-Delta (Delta-Sigma) modulated signal stream such as that used by Super Audio CD by the name of DSD (Direct Stream Digital).

**Picture**— A portion of an uncompressed video signal, a compressed video stream, or a sequence on a display that constitutes a single displayable image. For the purposes of CEA-861-E, picture refers to the pixel data transferred during a single video frame in the uncompressed video signal. A picture includes both the active image and bars.

**Picture Aspect Ratio**—Ratio of width to height dimension of the picture as delivered across the uncompressed digital interface, including any top, bottom, or side bars. Only two Picture Aspect Ratios are specified for this interface, 16:9 and 4:3.

**Pixel Data**—Color component samples transmitted over the interface during a single active pixel. These samples may, but need not, completely define a single picture element.

**Preferred Picture Aspect Ratio**—In a Dual Aspect Ratio DTV, the preferred aspect ratio of a given Video Format Timing (e.g., 720x480p) is the aspect ratio of the first such timing listed in the EDID data structure (see Section 4.1). This would be the picture aspect ratio that would be displayed if a DTV were to receive a Video Format Timing with no accompanying picture aspect ratio information (i.e., no AVI sent from source).

**Preferred Video Format**—The video format that a display manufacturer determines provides optimum image.

NOTE—Source implementers are encouraged to review Section 7.2.3 for related guidance.

**RGB**—A general representation of an analog or digital component video signal, where R represents the red color, G represents green, and B represents blue; and each component is sampled at a uniform rate (4,4,4). For the purpose of CEA-861-E, the signal is digital.

**Sink**—A device which receives an uncompressed A/V signal.

**Source**—A device which generates an uncompressed A/V signal.

**Source Pass-through Mode**—A mode supported by some media-based sources, wherein decompressed video passes directly (in its original format) to a sink without interlacing, deinterlacing, scaling, or frame rate conversion.

**sRGB**—The default RGB color space defined in IEC 61966-2-1 [34].

**Standard Definition Television (SDTV)**—A DTV capable of displaying 720x480i or 720x576i video in at least one of two picture aspect ratios, 16:9 or 4:3.

**sYCC<sub>601</sub>**—The luma-chroma-chroma (YCC) color space defined in Annex F of IEC 61966-2-1/Amendment 1 [35]. The ITU-R Rec. BT.601 [6] color conversion matrix is used to transform RGB values to YCC values. sYCC<sub>601</sub> color space can represent colors outside of the sRGB color gamut.

**Uncompressed Audio**—Linear Pulse Code Modulated (LPCM) and One Bit Audio.

**Unique Active Pixel**— A timing pattern consisting of one or more contiguous active pixels having the same (systematically repeated) pixel data. The number of active pixels in a unique active pixel is equal to the pixel repetition factor (PR+1).

**Unique Content Pixel**— A timing pattern consisting of one or more contiguous content pixels having the same (systematically repeated) pixel data.

**Video Field**—The period from the leading (active) edge of one vertical sync (Vsync) pulse to the same edge of the next Vsync pulse or the timing pattern associated with that period.

**Video Format**—A video format is sufficiently defined such that when it is received at the DTV, the sink has enough information to properly display an image. Although it is generally acceptable to define a video format by specifying only a video timing and a picture aspect ratio, a more complete definition requires additional information including a Color Space, a Quantization Range, and a Component Depth (N).

**Video Format Timing**—The waveform associated with a video format. Note that a specific Video Format Timing may be associated with more than one Video Format (e.g. 720x480p formatted in the 4:3 Picture Aspect Ratio or a 720x480p formatted in the 16:9 Picture Aspect Ratio).

**Video Frame**—The period (beginning and ending where the active edges of horizontal and vertical sync align) for vertical total lines to elapse or the repetitive timing pattern associated with that period. Interlaced timings have two video fields per video frame, while progressive timings have only one. Therefore, in the case of progressive timings, the terms video field and video frame are synonymous.

**Video Identification (ID) Code**—An integer value used to identify a particular Video Format listed in Table 4. Tables 2 and 3 use Video Identification Codes to cross reference a particular Video Format with its exact Video Timing.

**Video Line**—The period, lasting Htotal pixel clock periods, beginning and ending with the active edge of a horizontal sync pulse (Hsync). The term may also refer to a timing pattern that occurs during this period consisting of Htotal contiguous video pixels.

**Video Pixel**—The period delimited by two sequential pixel clock active edges. The term may also refer to the portion of a timing pattern where the interface transfers one unit of data. The unit of data transferred may be related to a single picture element or other information (e.g. Audio) and may convey the same information as the preceding video pixel.

**xvYCC<sub>601</sub>**—The extended gamut luma-chroma-chroma (YCC) color space defined in IEC 61966-2-4 [5]. The ITU-R Rec. BT.601 [6] color conversion matrix is used by 61966-2-4 [5] to transform RGB values to YCC values. The extent of the gamut is device dependent.

**xvYCC<sub>709</sub>**— The extended gamut luma-chroma-chroma (YCC) color space defined in IEC 61966-2-4 [5]. The ITU-R Rec. BT.709 [7] color conversion matrix is used by 61966-2-4 [5] to transform RGB values to YCC values. The extent of the gamut is device dependent.

**Y<sub>C<sub>B</sub></sub>C<sub>R</sub>**—A general representation of a digital component video signal, where Y represents luminance, C<sub>B</sub> represents the color blue, and C<sub>R</sub> represents red; The color component may be sub-sampled at half the rate as luminance (4:2:2) or may be sampled at a uniform rate (4:4:4). For the purposes of CEA-861-E, it may be considered a digital representation of YP<sub>B</sub>P<sub>R</sub>.

### 2.3 Symbols and Abbreviations

<b>AAC</b>	Advanced Audio Coding
<b>AFD</b>	Active Format Description
<b>AMOL96</b>	Automated Measurement of Lineups 96 (bits/field)
<b>ANSI</b>	American National Standards Institute
<b>ATRAC</b>	Adaptive Transform Acoustic Coding
<b>A/V</b>	Audio/Video
<b>AR</b>	Aspect Ratio
<b>AV/C</b>	Audio/Video Control
<b>AVI</b>	Auxiliary Video Information
<b>BD</b>	Blu-Ray Disc
<b>CD</b>	Compact Disk
<b>CEA</b>	Consumer Electronics Association
<b>CRT</b>	Cathode Ray Tube
<b>DAC</b>	Digital to Analog Converter
<b>DBS</b>	Direct Broadcast Satellite
<b>DDWG</b>	Digital Display Working Group
<b>DMT</b>	Display Monitor Timing
<b>DSC</b>	Digital Still Camera
<b>DSD</b>	Direct Stream Digital
<b>DST</b>	Direct Stream Transfer
<b>DTD</b>	Detailed Timing Descriptor
<b>DTV</b>	Digital Television
<b>DVC</b>	Digital Video Camera
<b>DVD</b>	Digital Versatile Disk
<b>D-VHS</b>	Digital VHS
<b>DVI</b>	Digital Visual Interface
<b>E-DDC</b>	Enhanced Display Data Channel
<b>E-EDID</b>	Enhanced Extended Display Identification Data Standard
<b>EDTV</b>	Enhanced Definition Television
<b>ELB</b>	End of Left Bar
<b>ETB</b>	End of Top Bar
<b>EUI</b>	Extended Unique Identifier
<b>HDCP</b>	High-bandwidth Digital Content Protection
<b>HD DVD</b>	High Definition DVD
<b>HDD</b>	Hard Disk Drive
<b>HDMI</b>	High-Definition Multimedia Interface
<b>HDTV</b>	High Definition Television

<b>HPD</b>	Hot Plug Detect
<b>IEC</b>	International Electrotechnical Commission
<b>IEEE</b>	Institute of Electrical and Electronics Engineers
<b>IRE</b>	Institute of Radio Engineers
<b>ISO</b>	International Organization for Standardization
<b>ITU</b>	International Telecommunications Union
<b>LCD</b>	Liquid Crystal Display
<b>LDI</b>	LVDS Display Interface
<b>LPCM</b>	Linear Pulse Code Modulation
<b>lsb</b>	least significant bit
<b>MAT</b>	MLP Audio Transport
<b>MLP</b>	Meridian Lossless Packing
<b>LVDS</b>	Low Voltage Differential Signaling
<b>MPEG</b>	Moving Picture Experts Group
<b>msb</b>	most significant bit
<b>NABTS</b>	North American Basic Teletext Specification
<b>OpenLDI</b>	Open LVDS Display Interface
<b>OUI</b>	Organizationally Unique Identifier
<b>PES</b>	Packetized Elementary Stream
<b>PMP</b>	Portable Media Player
<b>SACD</b>	Super Audio CD
<b>SADB</b>	Speaker Allocation Data Block
<b>SBB</b>	Start of Bottom Bar
<b>SDTV</b>	Standard Definition Television
<b>SMPTE</b>	Society of Motion Picture & Television Engineers
<b>SRB</b>	Start of Right Bar
<b>STB</b>	Set-Top Box
<b>SVD</b>	Short Video Descriptor
<b>TVG2X</b>	TVGuide 2X (bitrate)
<b>VBI</b>	Vertical Blanking Interval
<b>VCDB</b>	Video Capability Data Block
<b>VCR</b>	Video Cassette Recorder
<b>VESA</b>	Video Electronics Standards Association
<b>VIC</b>	Video Identification (ID) Code
<b>VSADB</b>	Vendor-Specific Audio Data Block
<b>VSDB</b>	Vendor Specific Data Block
<b>VSVDB</b>	Vendor-Specific Video Data Block
<b>WMA Pro</b>	Windows Media Audio Professional

## 2.4 Compliance Notation

As used in this document, “shall” denotes mandatory provisions of the standard. “Should” denotes a provision that is recommended but not mandatory. “May” denotes a feature whose presence does not preclude compliance and implementation of which is optional. “Optional” denotes items that may or may not be present in a compliant device.

## 2.5 Hexidecimal Notation

The characters 0x preceding numbers or letters A through F designate the following values as hexadecimal notation.

## 2.6 HxV Video Timing Notation

Video timings are sometimes expressed using HxV notation (e.g. "720x480"), where H and V are equal to the number of active pixels per active line and the number of active lines per video frame, respectively. The H value is sometimes surrounded by parenthesis and preceded by the number of unique active pixels - for example: "720(1440)x480". In this case, a unique active pixel is formed by systematically

repeating the preceding active pixel R-number of times such that the effective horizontal resolution is lower than the value indicated in the parentheses by a factor of  $1/(R+1)$  (see Table 2, Note 2 for details).

Video timings may also be expressed using the HxV @ F notation (e.g. "720x576i @ 50 Hz "), where a value F is appended to denote field frequency. The value F also refers to the video frame rate when the letter to the right of the value V is a 'p'. North American video timings usually have a slash '/' in the name (e.g. "720x480i @ 59.94/60 Hz") to delimit dual vertical frequencies. Here, the first vertical frequency is adjusted by a factor of exactly 1000/1001 (for NTSC broadcast compatibility) relative to the second (see Table 2, Note 3).

## 2.7 Bit Naming Conventions

The names of the individual bits of multi-bit data values are composed using a value's mnemonic followed by a bit number. The significance of each bit is indicated by the bit number according to little-endian convention (i.e. bit number 0 is the least significant). For example, the quantization value is given the mnemonic 'Q', which is associated with two bits named 'Q1' and 'Q0'. When the value Q=2, bit Q1=1 and bit Q0=0.

Future bits are a special case. These bits begin with the mnemonic 'F' followed by a bit number. In this case, bit numbers indicate location - not significance. Future bits shall be set to zero and ignored.

## 2.8 ASCII Codes, Characters & Strings

ASCII characters shall be encoded using either 7-bit or 8-bit codes as indicated. The least significant 7-bits shall encode characters according to ANSI INCITS [38], where ANSI INCITS bits b1 through b7 are mapped to bits 0 through 6, respectively. In the case of 8-bit codes, the msb (bit 7) shall always be set to zero.

## 3 Overview

CEA-861-E describes requirements for video sources and sinks that include an uncompressed, baseband, digital video interface. These requirements apply to any baseband digital video interface that makes use of VESA E-EDID (structures for discovery of supported video formats) [10] and supports 24-bit RGB. The 60 Hz/59.94 Hz video timings are based on analog formats already standardized in CEA-770.2-D [31] and CEA-770.3-C [32]. A preferred physical/link interface is not specified in CEA-861-E. See the annexes on how to apply CEA-861-E to the individual interfaces available at the time of this writing. Digital Visual Interface (DVI 1.0) [4] and OpenLDI 0.95 [8] can be used to enable minimal digital interface functionality. To take advantage of these enhancements, the physical interface also needs a way to transport CEA InfoFrames, digital audio, and  $YCbCr$  pixels from the source to the sink. The High-Definition Multimedia Interface (HDMI) [50] is capable of taking advantage of these enhancements.

Enhanced Extended Display Identification Data (E-EDID) was created by VESA to enable plug and play capabilities of sinks. This data, which would be stored in the sink, describes video formats that the sink is capable of receiving and rendering. The information is supplied to the source, over the interface, upon the request of the source. The source then chooses its output format, taking into account the format of the original video stream and the formats supported by the sink. The source (e.g., STB) is responsible for the format conversions necessary to supply video in an understandable form to the sink.

CEA-861-E includes the sink's ability to describe other capabilities in the E-EDID - in addition to supported video formats (e.g., digital audio). In those cases, the same basic mechanism applies (i.e. the source reads EDID data in the sink to determine its capabilities and then the source sends only audio and video formats the sink is capable of receiving).

The physical/link standards in Annex B, Annex C and Annex D do not support transport of closed captioning (CEA-608-C [44] and CEA-708-C [45]); therefore, the source processes these elements. Specifically, if closed captioning is to be displayed, it is decoded by the source, inserted into the video, and displayed as open captions. Similarly, if system information, program information, events, service descriptors, etc. are displayed, related graphical information is inserted into the video by the source.



Control of closed captioning settings, programs, events, etc. is a feature of the source, not supported by this interface and beyond the scope of CEA-861-E.

Furthermore, content advisory user menus, settings, and blocking are accommodated in the source, and are beyond the scope of CEA-861-E.

### 3.1 General Video Format Requirements

Any sink complying with CEA-861-E shall display video conforming to the following video format:

- generated according to the 640x480p @ 60Hz video timing as defined in Section 4;
- formatted in a 4:3 picture aspect ratio as described in Section 4.1; and
- coded with the default component depth, colorimetry and quantization range for IT video timing as specified in Section 5.

This video format is commonly referred to as "640x480p" throughout CEA-861-E.

In addition to the sink requirements above, any EDTV complying with CEA-861-E shall also display video conforming to the following video formats:

- generated according to the 720x480p @ 59.94/60Hz or the 720x576p @ 50Hz video timing as defined in Section 4;
- formatted in both picture aspect ratios (4:3 and 16:9) as described in Section 4.1; and
- coded with the default component depth, colorimetry and quantization range for standard-definition CE video timings as specified in Section 5.

This implicitly allows any source (intended to supply content to such a DTV) to only support 720x480p (720x576p for 50 Hz systems) or 640x480p. For the source to be able to supply high definition content to any HDTV, it needs to be capable of supporting 1920x1080i and 1280x720p since the HDTV may support only one of the two formats. It implies that, in some cases, the source (e.g., STB) would need to convert the video from the format at its input (e.g., 720x480i) to one of the formats supported by the DTV over this interface (e.g., 720x480p). For additional guidance for sources see Table 1 and Section 7.2.3. Throughout CEA-861-E the 720x480p @ 59.94/60Hz video timing is commonly referred to as "720x480p" and the 720x576p @ 50Hz video timing is commonly referred to as "720x576p."

In addition to the EDTV requirements above, any HDTV complying with CEA-861-E shall also display video conforming to the following video formats:

- generated according to at least one of the 1920x1080i @ 60Hz, 1920x1080i @ 50Hz, 1280x720p @ 60Hz or 1280x720p @ 50Hz video timings as defined in Section 4;
- formatted in a 16:9 picture aspect ratio as described in Section 4.1; and
- coded with the default component depth, colorimetry and quantization range for high-definition CE video timings as specified in Section 5.

Throughout CEA-861-E, the 1920x1080i @ 60Hz and the 1920x1080i @ 50 Hz video timings are commonly referred to as "1920x1080i". Also, the 1280x720p @ 60Hz and the 1280x720p @ 50Hz video timings are commonly referred to as "1280x720p".

Any sink complying with CEA-861-E may optionally display video conforming to the following video formats:

- generated according to the 720x480i @ 59.94/60Hz or the 720x576i @ 50Hz video timing as defined in Section 4;
- formatted in either picture aspect ratio (4:3 or 16:9) as described in Section 4.1; and
- coded with the default component depth, colorimetry and quantization range for standard-definition CE video timings as specified in Section 5.

Throughout CEA-861-E the 720x480i @ 59.94/60Hz video timing is commonly referred to as "720x480i" and the 720x576i @ 50 Hz video timing is commonly referred to as "720x576i".

Table 1 summarizes display requirements specified by CEA-861-E. Incorporated in the same table are recommendations for sources. These recommendations are based on the CEA's Definitions for Digital Television Products [43]. In the table, the CEA term “tuner” refers to a device that decodes a digital video signal that has been modulated onto an RF carrier and outputs video. To comply with CEA-861-E, a source does not have to be a tuner.

### 60 Hz Systems

CEA Definition	Video Format	EDTV (Display)	HDTV (Display)	EDTV Tuner (Source)	HDTV Tuner (Source)
SDTV	720(1440)x480i @ 59.94/60 Hz	o	o	o	o
EDTV	640x480p @ 60 Hz	✗	✗	✓ *	✓ *
EDTV	720x480p @ 59.94/60 Hz	✗	✗		
HDTV	1280x720p @ 60 Hz	o	✗ *	o	✓
HDTV	1920x1080i @ 60 Hz	o		o	✓

### 50 Hz Systems

CEA Definition	Video Format	EDTV (Display)	HDTV (Display)	EDTV Tuner (Source)	HDTV Tuner (Source)
SDTV	720(1440)x576i @ 50 Hz	o	o	o	o
EDTV	640x480p @ 60 Hz	✗	✗	✓ *	✓ *
EDTV	720x576p @ 50 Hz	✗	✗		
HDTV	1280x720p @ 50 Hz	o	✗ *	o	✓
HDTV	1920x1080i @ 50 Hz	o		o	✓

### Legend

✗	Required by CEA-861-E
✗ *	Either one of the two formats is required, the other is optional
✓	Recommended by CEA-861-E and implied by CEA DTV definitions
✓ *	Either one of the two formats is recommended, the other is optional
o	Optional

**Table 1 Video Format Timings—Support Requirements and Recommendations**

## 4 Video Formats and Waveform Timings

CEA-861-E interfaces transport uncompressed digital video using a variety of CE and IT video timings. This section describes the default IT 640x480 video timing as well as all of the standard CE video timings.

The balance of IT timings are documented in the VESA DMT [65], GTF [60, 64], and VESA CVT [57, 62] standards.

Throughout CEA-861-E, the term “video format timing” (or shorthand “video timing”) does not include aspect ratio, whereas the term “video format” does encompass the aspect ratio.

A video timing with a vertical frequency that is an integer multiple of 6.00 Hz (i.e. 24.00, 30.00, 60.00, 120.00 or 240.00 Hz) is considered to be the same as a video timing with the equivalent detailed timing information but where the vertical frequency is adjusted by a factor of 1000/1001 (i.e., 24/1.001, 30/1.001, 60/1.001, 120/1.001 or 240/1.001). That is, they are considered two versions of the same video timing but with slightly different pixel clock frequencies. Therefore, a DTV that declares it is capable of displaying a video timing with a vertical frequency that is either an integer multiple of 6 Hz or an integer multiple of 6 Hz adjusted by a factor of 1000/1001 shall be capable of displaying both versions of the video timing.

The additional low-resolution progressive video format timings (1440x240p, 2880x240p, 1440x288p, and 2880x288p) consist of one of several frame formats. These frame formats differ only by one or two scan lines in the vertical blanking interval. For that reason, they are treated as the same video format with a slight variation in the parameters (i.e., handled in a way similar to the 59.94Hz/60Hz formats). For this reason, if a sink declares support of one of these video formats of a specific picture aspect ratio (through EDID), then it shall support all variations of that video format of the same picture aspect ratio.

The mandatory and optional formats defined in CEA-861-E shall comply with the timing parameters in Table 2 and Table 3.

In Table 3, note that the Vfront, Vsync, and Vback values are defined in terms of video lines (see Section 2.2 “Video Line”). The reader is advised that the signals Hsync, Vsync, Data Enable, and Clock are encoded in an interface-specific manner. For details, see the specifications for DVI [4], OpenLDI [8] or HDMI [50].

Standard-definition video timings generally use negative vertical and horizontal sync, while high-definition video timings use positive.

Lines are always numbered sequentially from 1 to Vtotal and match the line numbers found in the given reference standard. In the case of high-definition video timings, the leading-line of vertical sync in field 1 is always line 1. In the case of standard-definition video timings, line 1 may coincide with the leading-line of vertical sync in field 1 or a line slightly before it. CEA-861-E video timings are sometimes based on legacy 60Hz standard-definition television standards that have slightly larger Vactive values (e.g. 483-lines vs. 480-lines). Such video timings begin line numbering before the leading-line of vertical sync in field 1 - in order to keep line-numbers in alignment with the legacy standard. The “Ln” column in Table 3 provides the line number of the leading-line of vertical sync in field 1 for each video timing code. See Annex L for examples.

For progressive video timings and Field 1 of interlace video timings, the leading (active) edge of Hsync and Vsync transitions shall be perfectly aligned plus or minus zero pixel clocks. In Field 2 of interlace video timings, the alignment between the leading (active) edge of Hsync and Vsync transitions shall be precisely a half-line (Htotal/2) plus or minus zero pixel clocks.

Field Rate <sup>5</sup>									(kHz)	(Hz)	(MHz)
	VIC	Hactive	Vactive	I/P	Htotal	Hblank <sup>5</sup>	Vtotal	Vblank <sup>5</sup>	H Freq <sup>5</sup>	V Freq <sup>4</sup>	Pixel Freq <sup>5</sup>
Low	60	1280	720	Prog	3300	2020	750	30	18.000	24.000 <sup>3</sup>	59.400
	61	1280	720	Prog	3960	2680	750	30	18.750	25.000	74.250
	62	1280	720	Prog	3300	2020	750	30	22.500	30.000 <sup>3</sup>	74.250
	32	1920	1080	Prog	2750	830	1125	45	27.000	24.000 <sup>3</sup>	74.250
	33	1920	1080	Prog	2640	720	1125	45	28.125	25.000	74.250
	34	1920	1080	Prog	2200	280	1125	45	33.750	30.000 <sup>3</sup>	74.250

Table 2 Video Format Timings—Detailed Timing Information

Field Rate <sup>5</sup>									(kHz)	(Hz)	(MHz)
	VIC	Hactive	Vactive	I/P	Htotal	Hblank <sup>5</sup>	Vtotal	Vblank <sup>5</sup>	H Freq <sup>5</sup>	V Freq <sup>4</sup>	Pixel Freq <sup>5</sup>
50Hz	17,18	720	576	Prog	864	144	625	49	31.250	50.000	27.000
	19	1280	720	Prog	1980	700	750	30	37.500	50.000	74.250
	20	1920	1080	Int	2640	720	1125	22.5 <sup>1</sup>	28.125	50.000	74.250
	21,22	1440 <sup>2</sup>	576	Int	1728 <sup>2</sup>	288	625	24.5 <sup>1</sup>	15.625	50.000	27.000
	23,24	1440 <sup>2</sup>	288	Prog	1728 <sup>2</sup>	288	312	24	15.625	50.080	27.000
	23,24	1440 <sup>2</sup>	288	Prog	1728 <sup>2</sup>	288	313	25	15.625	49.920	27.000
	23,24	1440 <sup>2</sup>	288	Prog	1728 <sup>2</sup>	288	314	26	15.625	49.761	27.000
	25,26	2880 <sup>2</sup>	576	Int	3456 <sup>2</sup>	576	625	24.5 <sup>1</sup>	15.625	50.000	54.000
	27,28	2880 <sup>2</sup>	288	Prog	3456 <sup>2</sup>	576	312	24	15.625	50.080	54.000
	27,28	2880 <sup>2</sup>	288	Prog	3456 <sup>2</sup>	576	313	25	15.625	49.920	54.000
	27,28	2880 <sup>2</sup>	288	Prog	3456 <sup>2</sup>	576	314	26	15.625	49.761	54.000
	29,30	1440 <sup>2</sup>	576	Prog	1728 <sup>2</sup>	288	625	49	31.250	50.000	54.000
	31	1920	1080	Prog	2640	720	1125	45	56.250	50.000	148.500
	37,38	2880 <sup>2</sup>	576	Prog	3456 <sup>2</sup>	576	625	49	31.250	50.000	108.000
	39	1920	1080	Int	2304	384	1250	85	31.250	50.000	72.000
60Hz <sup>3</sup>	1	640	480	Prog	800	160	525	45	31.469	59.940 <sup>3</sup>	25.175
	2,3	720	480	Prog	858	138	525	45	31.469	59.940 <sup>3</sup>	27.000
	4	1280	720	Prog	1650	370	750	30	45.000	60.000 <sup>3</sup>	74.250
	5	1920	1080	Int	2200	280	1125	22.5 <sup>1</sup>	33.750	60.000 <sup>3</sup>	74.250
	6,7	1440 <sup>2</sup>	480	Int	1716 <sup>2</sup>	276	525	22.5 <sup>1</sup>	15.734	59.940 <sup>3</sup>	27.000
	8,9	1440 <sup>2</sup>	240	Prog	1716 <sup>2</sup>	276	262	22	15.734	60.054 <sup>3</sup>	27.000
	8,9	1440 <sup>2</sup>	240	Prog	1716 <sup>2</sup>	276	263	23	15.734	59.826 <sup>3</sup>	27.000
	10,11	2880 <sup>2</sup>	480	Int	3432 <sup>2</sup>	552	525	22.5 <sup>1</sup>	15.734	59.940 <sup>3</sup>	54.000
	12,13	2880 <sup>2</sup>	240	Prog	3432 <sup>2</sup>	552	262	22	15.734	60.054 <sup>3</sup>	54.000
	12,13	2880 <sup>2</sup>	240	Prog	3432 <sup>2</sup>	552	263	23	15.734	59.826 <sup>3</sup>	54.000
	14,15	1440 <sup>2</sup>	480	Prog	1716 <sup>2</sup>	276	525	45	31.469	59.940 <sup>3</sup>	54.000
	16	1920	1080	Prog	2200	280	1125	45	67.500	60.000 <sup>3</sup>	148.500
35,36	2880 <sup>2</sup>	480	Prog	3432 <sup>2</sup>	552	525	45	31.469	59.940 <sup>3</sup>	108.000	

Table 2 Video Format Timings—Detailed Timing Information (continued)

Field Rate <sup>5</sup>									(kHz)	(Hz)	(MHz)
	VIC	Hactive	Vactive	I/P	Htotal	Hblank <sup>5</sup>	Vtotal	Vblank <sup>5</sup>	H Freq <sup>5</sup>	V Freq <sup>4</sup>	Pixel Freq <sup>5</sup>
100 Hz	40	1920	1080	Int	2640	720	1125	22.5 <sup>1</sup>	56.250	100.00	148.500
	41	1280	720	Prog	1980	700	750	30	75.000	100.00	148.500
	42, 43	720	576	Prog	864	144	625	49	62.500	100.00	54.000
	44, 45	1440 <sup>2</sup>	576	Int	1728 <sup>2</sup>	288	625	24.5 <sup>1</sup>	31.250	100.00	54.000
	64	1920	1080	Prog	2640	720	1125	45	112.500	100.00	297.000
120 Hz <sup>3</sup>	46	1920	1080	Int	2200	280	1125	22.5 <sup>1</sup>	67.500	120.00 <sup>3</sup>	148.500
	47	1280	720	Prog	1650	370	750	30	90.000	120.00 <sup>3</sup>	148.500
	48, 49	720	480	Prog	858	138	525	45	62.937	119.88 <sup>3</sup>	54.000
	50, 51	1440 <sup>2</sup>	480	Int	1716 <sup>2</sup>	276	525	22.5 <sup>1</sup>	31.469	119.88 <sup>3</sup>	54.000
	63	1920	1080	Prog	2200	280	1125	45	135.000	120.00 <sup>3</sup>	297.000
200 Hz	52, 53	720	576	Prog	864	144	625	49	125.000	200.00	108.00
	54, 55	1440 <sup>2</sup>	576	Int	1728 <sup>2</sup>	288	625	24.5 <sup>1</sup>	62.500	200.00	108.00
240 Hz <sup>3</sup>	56,57	720	480	Prog	858	138	525	45	125.874	239.76 <sup>3</sup>	108.000
	58,59	1440 <sup>2</sup>	480	Int	1716 <sup>2</sup>	276	525	22.5 <sup>1</sup>	62.937	239.76 <sup>3</sup>	108.000

1. V blanking—Fractional values indicate that the number of blanking lines varies (see timing diagram for more details).

2. the pixels for the 720(1440)x480i@59.94/60Hz, 720(1440)x240p@59.94/60Hz, 720(1440)x576i@50Hz, and 720(1440)x288p@50Hz video formats are double clocked to meet minimum speed requirements of the interface, thus H active is shown as 1440, instead of 720. At higher field rates, these formats continue to be double clocked - even though double clocking is unnecessary. Each pixel of the 1440xN 480p and 576p formats, as well as the 2880xN 480i, 240p, 480p, 576i, 288p, and 576p formats, is repeated a variable number of times. The repeat value is communicated using the AVI InfoFrames (see Section 6.4).

3. A video timing with a vertical frequency that is an integer multiple of 6.00 Hz (i.e. 24.00, 30.00, 60.00, 120.00 or 240.00 Hz) is considered to be the same as a video timing with the equivalent detailed timing information but where the vertical frequency is adjusted by a factor of 1000/1001 (i.e., 24/1.001, 30/1.001, 60/1.001, 120/1.001 or 240/1.001). That is, they are considered two versions of the same video timing but with slightly different pixel clock frequencies. The vertical frequencies of the 240p, 480p, and 480i video formats are typically adjusted by a factor of exactly 1000/1001 for NTSC video compatibility, while the 576p, 576i, and the HDTV video formats are not. The VESA DMT standard [65] specifies a  $\pm 0.5\%$  pixel clock frequency tolerance. Therefore, the nominally 25.175 MHz pixel clock frequency value given for video identification code 1 may be adjusted to 25.2 MHz to obtain an exact 60 Hz vertical frequency.

4. To avoid fractional frame rate conversions in source and sinks, sources should use the exact vertical frequencies of 25.000 Hz, 50.000 Hz, 100.000 Hz, 120.000 Hz, 200.000 Hz, and 240.000 Hz at 25 Hz, 50 Hz, 100 Hz, 120 Hz, 200 Hz, and 240 Hz, respectively. Likewise, sources should use the exact vertical frequencies of  $(24 * 1000) / 1001$  Hz,  $(30 * 1000) / 1001$  Hz,  $(60 * 1000) / 1001$  Hz,  $(120 * 1000) / 1001$  Hz, and  $(240 * 1000) / 1001$  Hz at 24.98 Hz, 29.97 Hz, 59.94 Hz, 119.88 Hz, 239.76 Hz, respectively.

5. Data in this column is provided for informational purposes only.

**Table 2 Video Format Timings—Detailed Timing Information (continued)**

Field Rate	VIC	Fig	Hfront	Hsync	Hback	Hpol <sup>18</sup>	Vfront	Vsync	Vback	Vpol <sup>18</sup>	Ln	Reference Standard	Notes
Low	60	2	1760	40	220	P	5	5	20	P	1	SMPTE 296M [40]	1,2, 25
	61	2	2420	40	220	P	5	5	20	P	1	SMPTE 296M [40]	1,2
	62	2	1760	40	220	P	5	5	20	P	1	SMPTE 296M [40]	1,2
	32	2	638	44	148	P	4	5	36	P	1	SMPTE 274M [2]	14
	33	2	528	44	148	P	4	5	36	P	1	SMPTE 274M [2]	14
	34	2	88	44	148	P	4	5	36	P	1	SMPTE 274M [2]	14
50Hz	17,18	1	12	64	68	N	5	5	39	N	1	ITU-R BT.1358 [56]	
	19	2	440	40	220	P	5	5	20	P	1	SMPTE 296M [40]	1,2
	20	4	528	44	148	P	2	5	15	P	1	SMPTE 274M [2]	1,2
	21,22	3	24	126	138	N	2	3	19	N	1	ITU-R BT.656-4 [54]	6, 15
	23,24	1	24	126	138	N	2 <sup>22</sup>	3	19	N	1	ITU-R BT.1358 [56]	7, 14, 19
	23,24	1	24	126	138	N	3 <sup>23</sup>	3	19	N	1	ITU-R BT.1358 [56]	7, 14, 15, 19
	23,24	1	24	126	138	N	4 <sup>24</sup>	3	19	N	1	ITU-R BT.1358 [56]	7, 14, 15, 19
	25,26	3	48	252	276	N	2	3	19	N	1	ITU-R BT.656-4 [54] <sup>17</sup>	8, 13, 14, 15
	27,28	1	48	252	276	N	2 <sup>22</sup>	3	19	N	1	ITU-R BT.656-4 [54] <sup>17</sup>	7, 8, 12, 13,19
	27,28	1	48	252	276	N	3 <sup>23</sup>	3	19	N	1	ITU-R BT.656-4 [54] <sup>17</sup>	7, 8, 12, 13,19
	27,28	1	48	252	276	N	4 <sup>24</sup>	3	19	N	1	ITU-R BT.656-4 [54] <sup>17</sup>	7, 8, 12, 13,19
	29,30	1	24	128	136	N	5	5	39	N	1	ITU-R BT.1358 [56]	9, 10, 14
	31	2	528	44	148	P	4	5	36	P	1	SMPTE 274M [2]	14
37,38	1	48	256	272	N	5	5	39	N	1	ITU-R BT.1358 [56]	9, 11	
39	5	32	168	184	P	23	5	57	N	1	AS 4933.1-2005 [67]	5	
60Hz	1	1	16	96	48	N	10	2	33	N	1	VESA DMT [65]	3, 4
	2,3	1	16	62	60	N	9	6	30	N	7	CEA-770.2-D [31]	2
	4	2	110	40	220	P	5	5	20	P	1	CEA-770.3-C [32]	1,2
	5	4	88	44	148	P	2	5	15	P	1	CEA-770.3-C [32]	1,2
	6,7	3	38	124	114	N	4	3	15	N	4	CEA-770.2-D [31]	2, 15
	8,9	1	38	124	114	N	4 <sup>20</sup>	3	15	N	4	CEA-770.2-D [31] <sup>17</sup>	7, 14, 15, 19
	8,9	1	38	124	114	N	5 <sup>21</sup>	3	15	N	4	CEA-770.2-D [31] <sup>17</sup>	7, 14, 15, 19
	10,11	3	76	248	228	N	4	3	15	N	4	CEA-770.2-D [31] <sup>17</sup>	8, 13
	12,13	1	76	248	228	N	4 <sup>20</sup>	3	15	N	4	CEA-770.2-D [31] <sup>17</sup>	7, 8, 13, 19
	12,13	1	76	248	228	N	5 <sup>21</sup>	3	15	N	4	CEA-770.2-D [31] <sup>17</sup>	7, 8, 13, 19
	14,15	1	32	124	120	N	9	6	30	N	7	CEA-770.2-D [31]	9, 10, 13, 14
	16	2	88	44	148	P	4	5	36	P	1	SMPTE 274M [2]	14
35,36	1	64	248	240	N	9	6	30	N	7	CEA-770.2-D [31]	9, 11	

Table 3 Video Format Timings—Detailed Sync Information

Field Rate	VIC	Fig	Hfront	Hsync	Hback	Hpol	Vfront	Vsync	Vback	Vpol	Ln	Reference Standard	Notes
100 Hz	40	4	528	44	148	P	2	5	15	P	1	SMPTE 274M [2]	
	41	2	440	40	220	P	5	5	20	P	1	SMPTE 296M [40]	
	42, 43	1	12	64	68	N	5	5	39	N	1	ITU-R BT.1358 [56]	
	44, 45	3	24	12 6	138	N	2	3	19	N	1	ITU-R BT.656-4 [54]	16
	64	2	528	44	148	P	4	5	36	P	1	SMPTE 274M [2]	
120 Hz	46	4	88	44	148	P	2	5	15	P	1	SMPTE 274M [2]	
	47	2	110	40	220	P	5	5	20	P	1	SMPTE 296M [40]	
	48, 49	1	16	62	60	N	9	6	30	N	7	CEA-770.2-D [31]	
	50, 51	3	38	12 4	114	N	4	3	15	N	4	CEA-770.2-D [31]	16
	63	2	88	44	148	P	4	5	36	P	1	SMPTE 274M [2]	
200 Hz	52, 53	1	12	64	68	N	5	5	39	N	1	ITU-R BT.1358 [56]	
	54, 55	3	24	12 6	138	N	2	3	19	N	1	ITU-R BT.656-4 [54]	16
240 Hz	56,57	1	16	62	60	N	9	6	30	N	7	CEA-770.2-D [31]	
	58,59	3	38	12 4	114	N	4	3	15	N	4	CEA-770.2-D [31]	16

**Notes:**

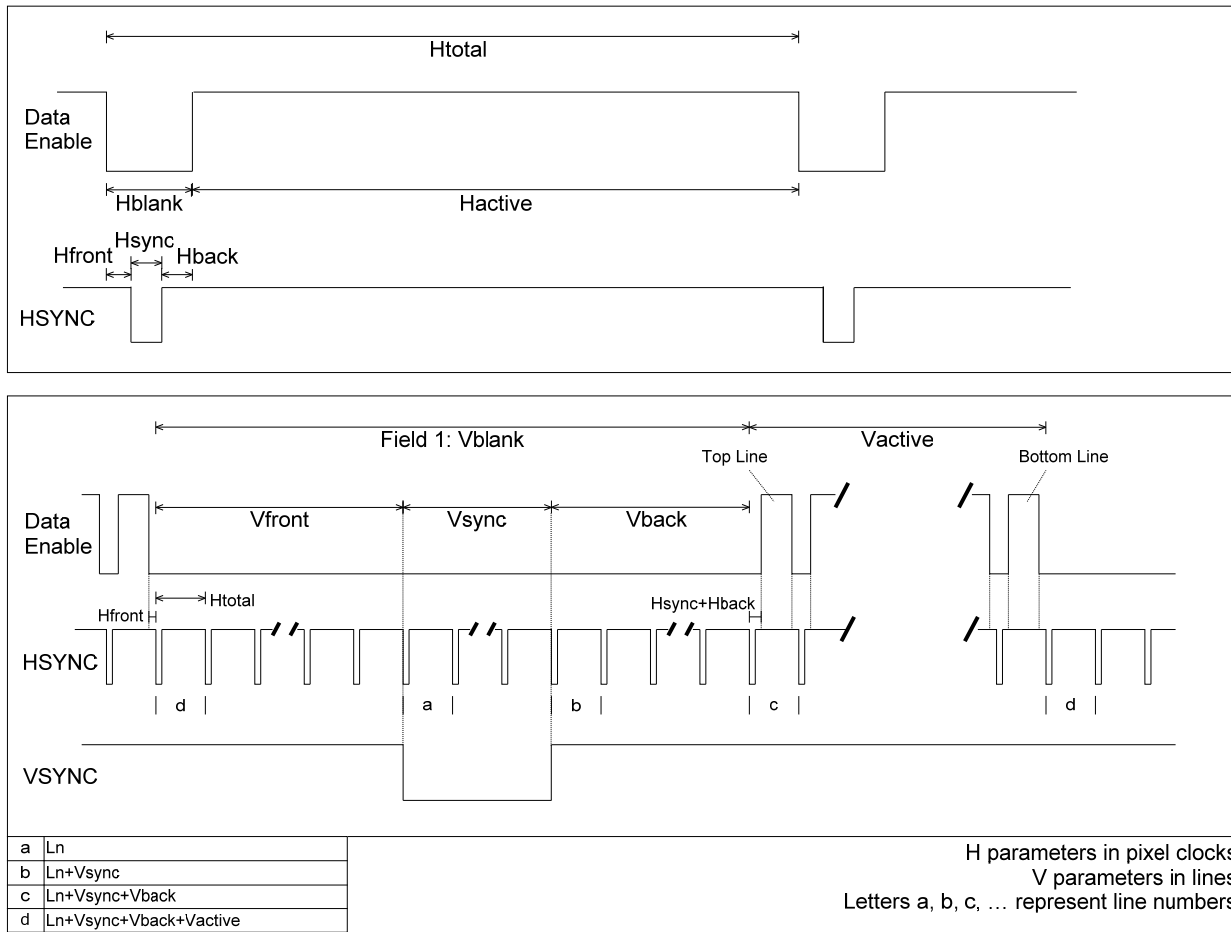
- The reference standard uses tri-level sync, while CEA-861-E uses bi-level. Bi-level sync timing is accomplished using the second half of the reference standard's tri-level sync, defining the actual sync time to be the rising edge of that pulse.
- The reference standard uses a composite sync while CEA-861-E uses separate sync signals, thus eliminating the need for serrations during vertical sync.
- VESA defines blanking as not including the border while CEA-861-E includes the border within the blanking interval.
- Uses default IT color space, RGB components, and full range 8-bit color coding & quantization (see Section 5).
- Is specifically designed for use with 31.25 kHz constant horizontal rate cathode-ray tube televisions and has a total of 1250 vertical lines – instead of the normal 1125 found in SMPTE 274 based timings. It has a frame, which is split into two unequal fields of 624.5 and 625.5 lines. The video format is specifically designed for use with special 31.25 kHz constant horizontal rate cathode-ray tube televisions and should be used with caution. Timing is similar to the 1250/50/2:1 system that described in Australian AS 4933.1-2005 standard [67].
- Same as the reference standard except for horizontal and vertical synchronization pulse durations, which are specified in ITU-R BT.711-1 [55] and ITU-R BT.470-6 [53]. Thus, the clock is 27 MHz.
- There are two or three video frame timings that differ only in the number of blanking lines in the vertical blanking interval of the frame. All are considered variations of the same video timing.
- Represents a superset of game console timings with variable repetition factors. Encompasses all of the following cases:
  - 2880/10=288 pixels/line
  - 2880/8=360 pixels/line
  - 2880/7=411 pixels/line
  - 2880/5=576 pixels/line
  - 2880/4=720 pixels/line

Typically has bars on the left and right sides that are 160/n pixels wide, where n is the repetition factor.

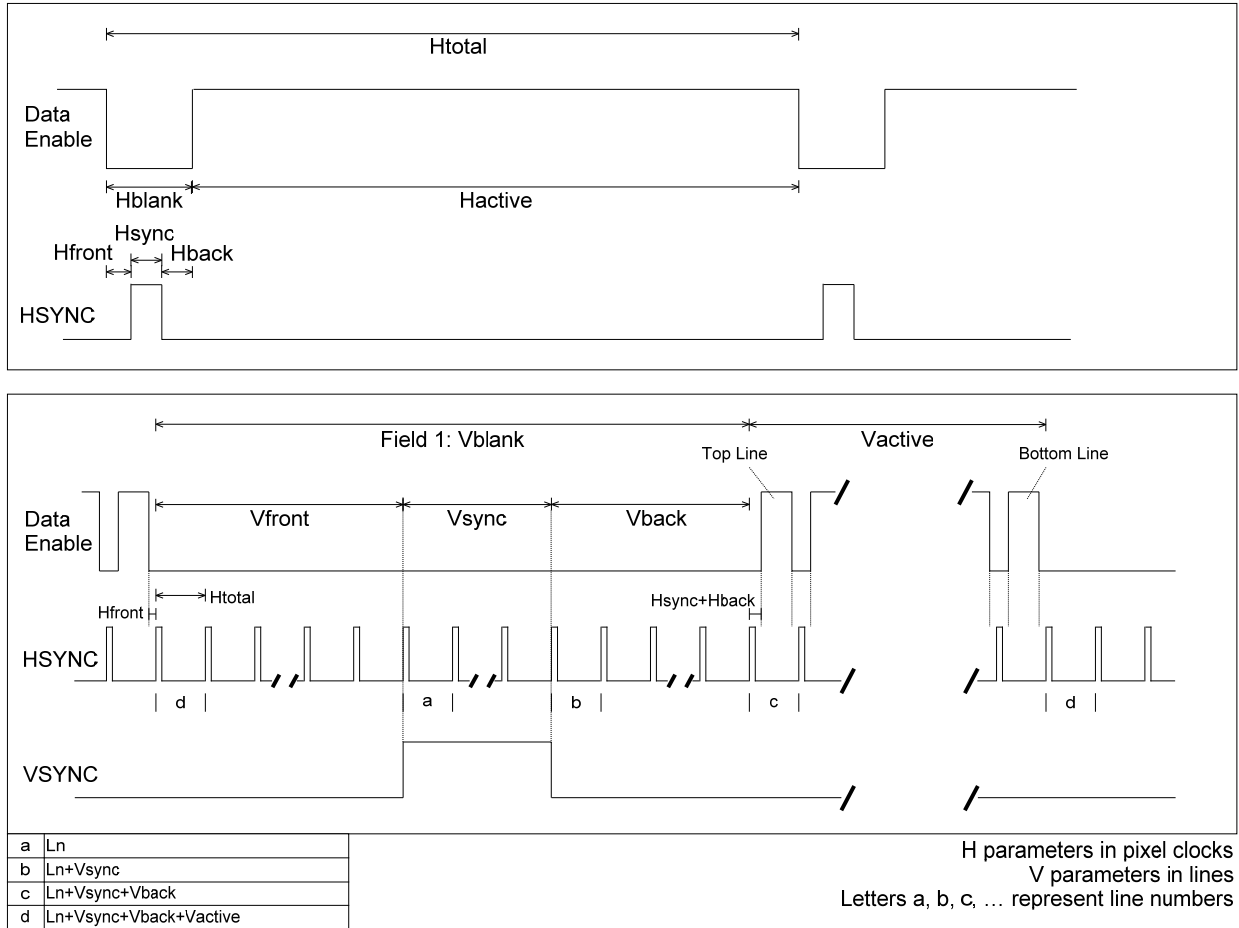
9. Represents a superset of timings with specific repetition factors that provide either additional bandwidth for carrying audio data or increased horizontal video resolution.
10. Is a superset of video formats encompassing all of the following cases:  
 a)  $1440/2=720$  pixels/line  
 b)  $1440/1=1440$  pixels/line
11. Is a superset of video formats encompassing all of the following cases:  
 a)  $2880/4=720$  pixels/line  
 b)  $2880/2=1440$  pixels/line  
 c)  $2880/1=2880$  pixels/line
12. The exact video timing depends upon the pixel repetition factor specified in the AVI InfoFrame.
13. If this video timing is advertised in the EDID, the sink shall have an interface capable of signaling pixel repetition via AVI InfoFrames (e.g. HDMI) and shall accept all listed pixel repetition factors.
14. It is likely that non-HDMI sources may not recognize this video format in a Detailed Timing Descriptor.
15. Assumes the pixels are double-clocked to meet minimum clock speed requirements for the interface.
16. Assumes the pixels are double-clocked.
17. This is a "gaming" format. Progressive timing is obtained by removing the second field of the reference standard's interlace timing.
18. Hpol and Vpol stand for horizontal and vertical sync pulse polarity, respectively. The value 'N' signifies negative polarity, where the signal stays mostly high (at a logic '1') and only pulses low (to a logic '0') during the sync pulse. Likewise, the value 'P' signifies positive polarity, where the signal stays mostly low (at a logic '0') and only pulses high (to a logic '1') during the sync pulse.
19. Vfront varies as a function of Vtotal.
20. This value applies when Vtotal is 262 lines.
21. This value applies when Vtotal is 263 lines.
22. This value applies when Vtotal is 312 lines.
23. This value applies when Vtotal is 313 lines.
24. This value applies when Vtotal is 314 lines.
25. This video timing has been modified from the one listed in the reference standard. The reference standard specifies an odd Htotal greater than 4096, which is incompatible with legacy silicon. CEA-861-E instead uses the referenced standard's 720p30 video timing with a reduced pixel clock frequency to obtain 24Hz.

**Table 3 Video Format Timings—Detailed Sync Information (continued)**

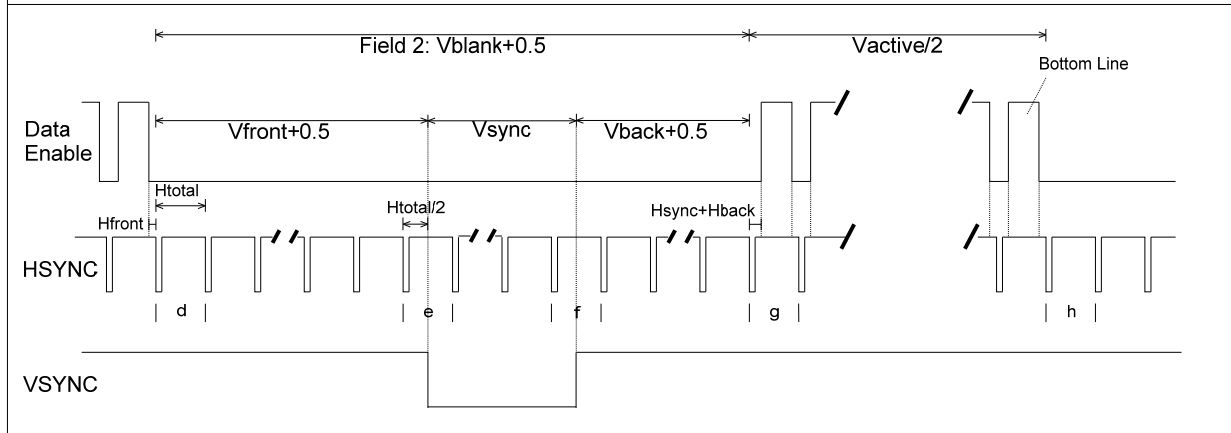
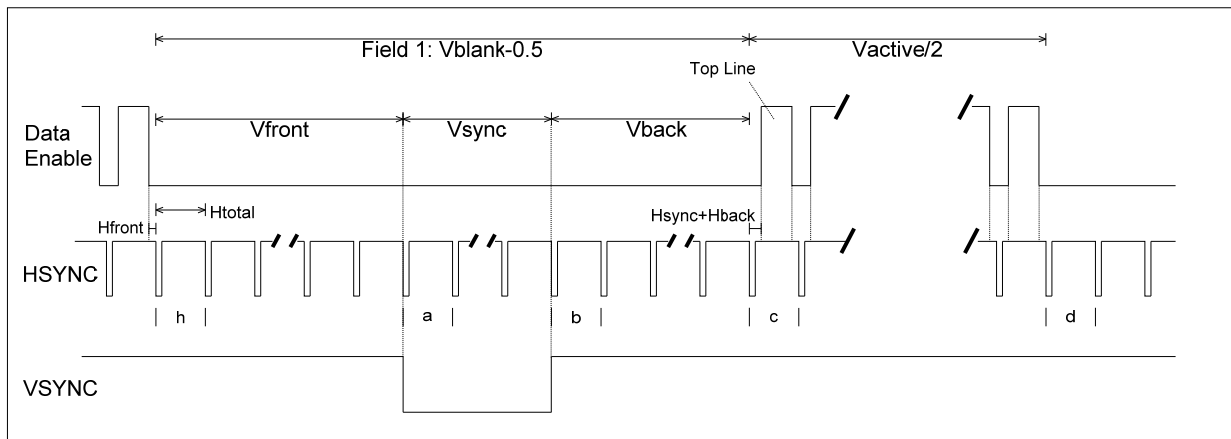
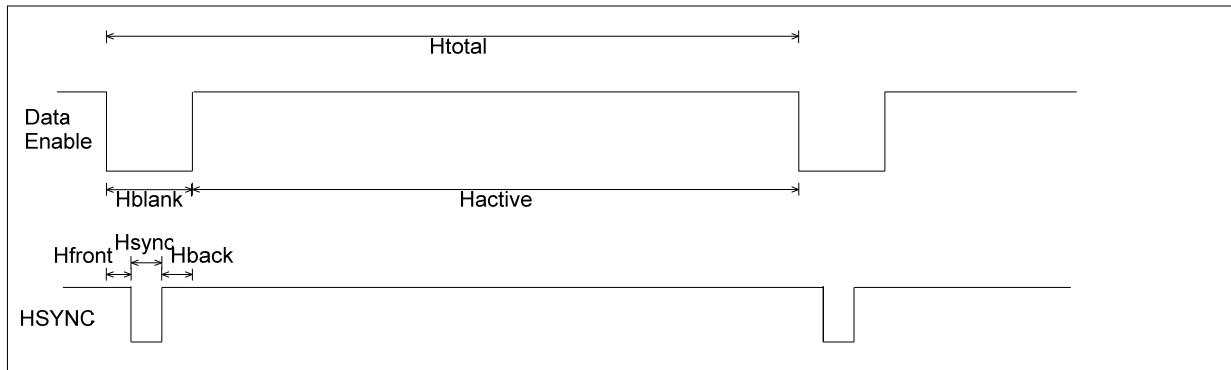




**Figure 1. General Progressive Video Format Timing (Negative Sync)**



**Figure 2. General Progressive Video Format Timing (Positive Sync)**



a	$L_n$
b	$L_n + V_{sync}$
c	$L_n + V_{sync} + V_{back}$
d	$L_n + V_{sync} + V_{back} + V_{active}/2$
e	$L_n + V_{sync} + V_{back} + V_{active}/2 + V_{front}$
f	$L_n + 2 * V_{sync} + V_{back} + V_{active}/2 + V_{front}$
g	$L_n + 2 * V_{sync} + 2 * V_{back} + V_{active}/2 + V_{front} + 1$
h	$L_n + 2 * V_{sync} + 2 * V_{back} + V_{active} + V_{front} + 1$

H parameters in pixel clocks  
 V parameters in lines  
 Letters a, b, c, ... represent line numbers.

**Figure 3 General Interlaced Video Format Timing (Negative Sync)**

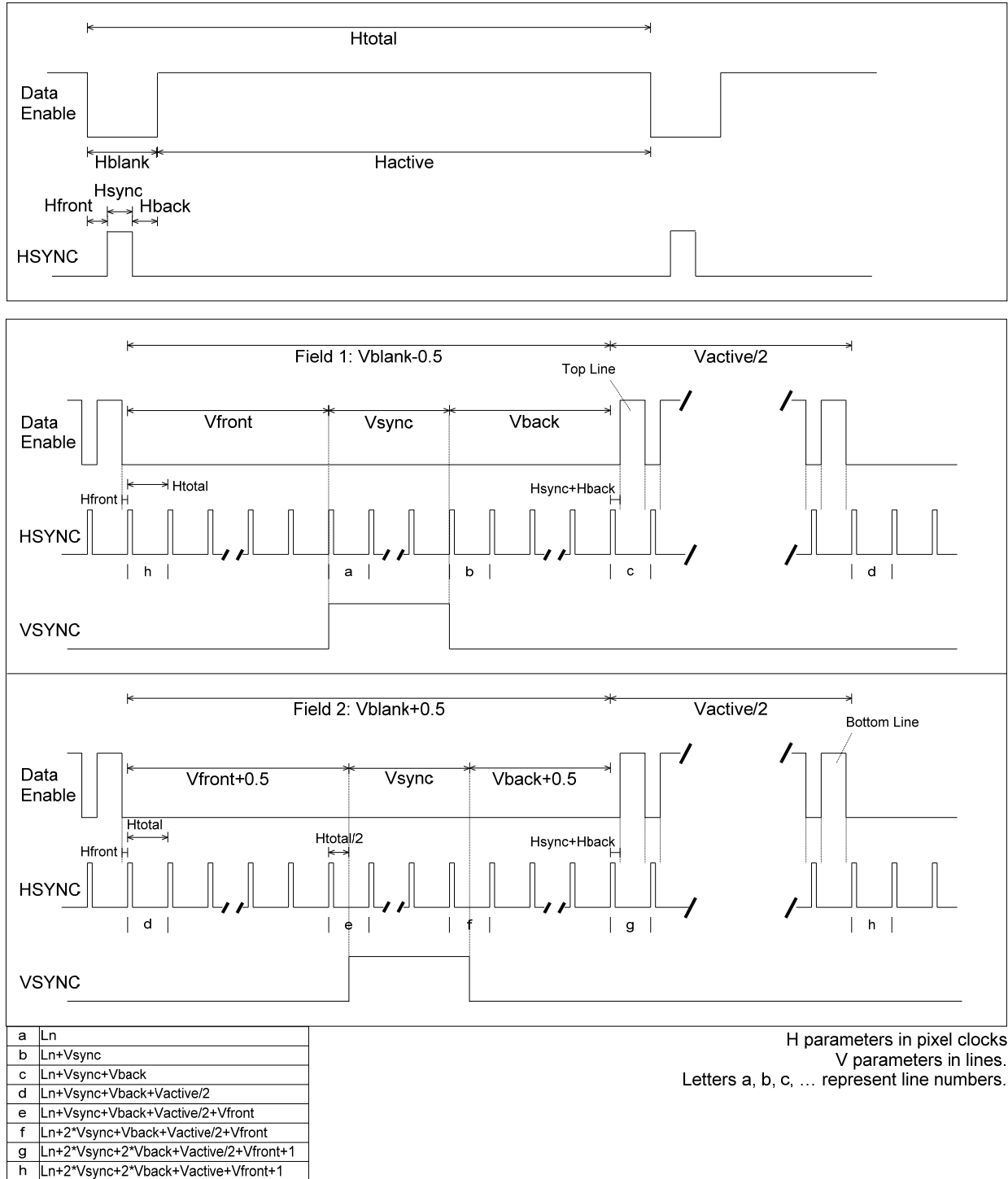


Figure 4. General Interlaced Video Format Timing (Positive Sync)

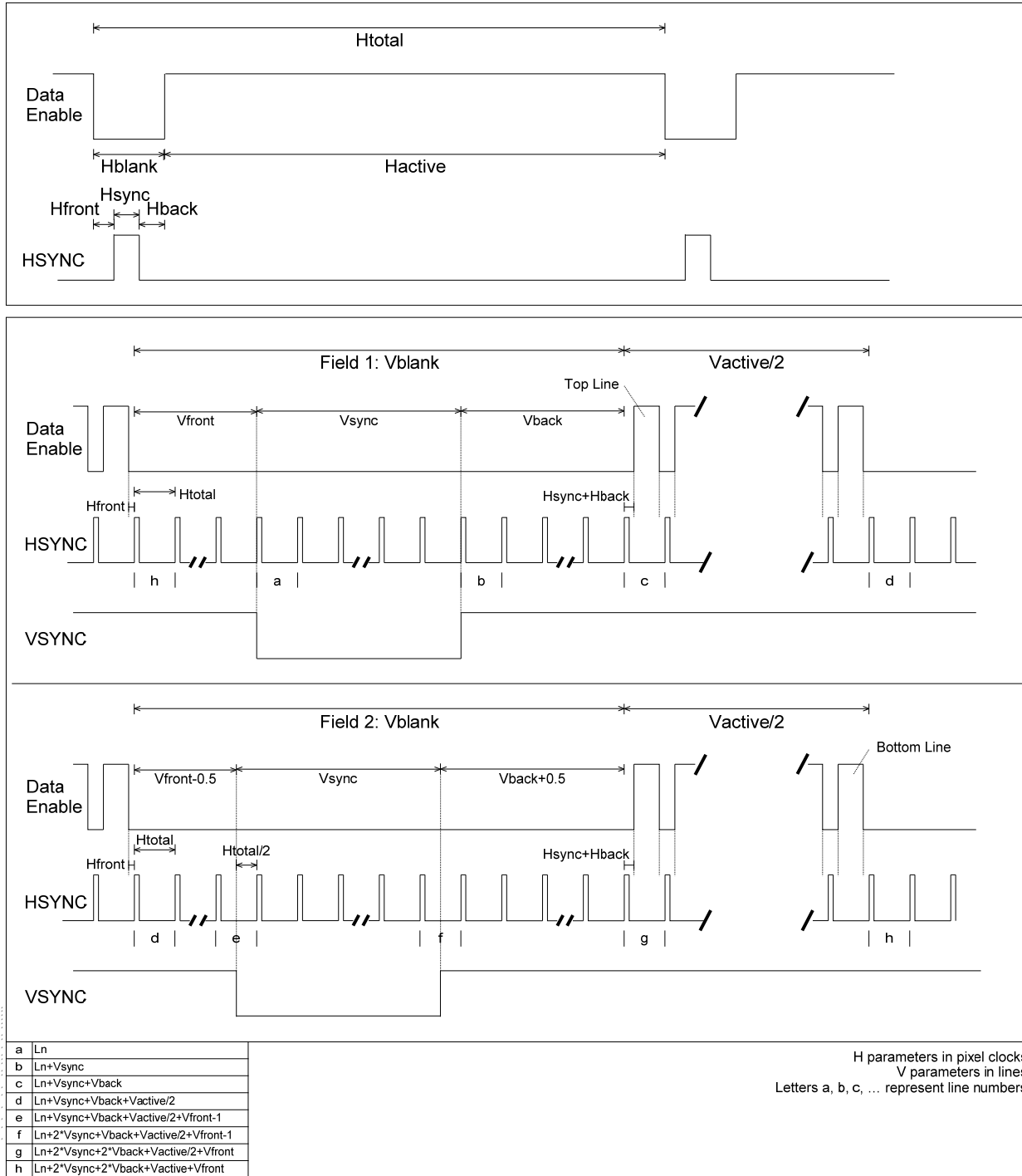


Figure 5 Special Interlaced Video Format Timing (Even Vtotal)

#### 4.1 Aspect Ratio

A DTV should always indicate its native (physical) aspect ratio in the EDID version 1, revision 3 block's "Max Horizontal Image Size" and "Max Vertical Image Size" fields even if the maximum image size is unknown or variable. Typically, the ratio of these two fields is 16:9 or 4:3 though this may not be true for some displays with non-standard aspect ratios. The source should use these fields to determine the native aspect ratio of the display.

The 480p, 480i, 240p, 576p, 576i, and 288p formats are available in two different aspect ratios (4:3 and 16:9). Video formats with the same timing, but different picture aspect ratios are considered different formats that can be independently supported and discovered. These are referred to as dual-aspect ratio timings.

For any dual-aspect ratio video timing, the Preferred Picture Aspect Ratio for that timing is indicated by the first listing of that timing in the EDID. When receiving a signal not accompanied by an aspect ratio indication (because no AVI InfoFrame is transmitted) a DTV shall assume that the aspect ratio is the Preferred Picture Aspect Ratio for the transmitted video timing.

If a Dual Aspect Ratio DTV is receiving a video format timing for which it has declared support for both picture aspect ratios in EDID and the source has indicated the picture aspect ratio by including the AVI in the video stream, then the DTV shall display the picture in the aspect ratio that has been indicated by the source in the AVI. If the source does not support transmission of the AVI and the source supports both of the dual-aspect ratio video timing formats for a particular video timing defined by the sink, then the source shall provide the video to the DTV in the Preferred Picture Aspect Ratio.

For a display device to simultaneously support both formats, the source needs a way to let the display device know the picture aspect ratio in which the video should be displayed. A DTV shall list only one picture aspect ratio of any dual-aspect ratio timing unless it is capable of receiving and decoding the AVI InfoFrame defined in Section 6.

However, it is possible for a DTV that has no support for the AVI InfoFrame to still support both aspect ratios of such formats as a user programmable option. In that case, the EDID Detailed Timing Descriptor could be modified during operation to reflect the selected picture aspect ratio and the change could be signaled to the source (e.g. with Hot Plug Detect on DVI or HDMI). The effects on the EDID data structure are explained in Section 7.2.2. See Table 4 for Video ID Code and Aspect Ratios.

VIC	Formats	Field Rate	Picture Aspect Ratio (H:V) <sup>1</sup>	Pixel Aspect Ratio (H:V)
1	640x480p	59.94Hz/60Hz	4:3	1:1
2	720x480p	59.94Hz/60Hz	4:3	8:9
3	720x480p	59.94Hz/60Hz	16:9	32:27
4	1280x720p	59.94Hz/60Hz	16:9	1:1
5	1920x1080i	59.94Hz/60Hz	16:9	1:1
6	720(1440)x480i	59.94Hz/60Hz	4:3	8:9
7	720(1440)x480i	59.94Hz/60Hz	16:9	32:27
8	720(1440)x240p	59.94Hz/60Hz	4:3	4:9
9	720(1440)x240p	59.94Hz/60Hz	16:9	16:27
10	2880x480i	59.94Hz/60Hz	4:3	2:9 – 20:9 <sup>2</sup>
11	2880x480i	59.94Hz/60Hz	16:9	8:27 -80:27 <sup>2</sup>
12	2880x240p	59.94Hz/60Hz	4:3	1:9 – 10:9 <sup>2</sup>
13	2880x240p	59.94Hz/60Hz	16:9	4:27 – 40:27 <sup>2</sup>
14	1440x480p	59.94Hz/60Hz	4:3	4:9 or 8:9 <sup>3</sup>
15	1440x480p	59.94Hz/60Hz	16:9	16:27 or 32:27 <sup>3</sup>
16	1920x1080p	59.94Hz/60Hz	16:9	1:1
17	720x576p	50Hz	4:3	16:15
18	720x576p	50Hz	16:9	64:45
19	1280x720p	50Hz	16:9	1:1
20	1920x1080i	50Hz	16:9	1:1
21	720(1440)x576i	50Hz	4:3	16:15
22	720(1440)x576i	50Hz	16:9	64:45
23	720(1440)x288p	50Hz	4:3	8:15
24	720(1440)x288p	50Hz	16:9	32:45
25	2880x576i	50Hz	4:3	2:15 – 20:15 <sup>2</sup>
26	2880x576i	50Hz	16:9	16:45-160:45 <sup>2</sup>
27	2880x288p	50Hz	4:3	1:15 – 10:15 <sup>2</sup>
28	2880x288p	50Hz	16:9	8:45 – 80:45 <sup>2</sup>
29	1440x576p	50Hz	4:3	8:15 or 16:15 <sup>3</sup>
30	1440x576p	50Hz	16:9	32:45 or 64:45 <sup>3</sup>
31	1920x1080p	50Hz	16:9	1:1
32	1920x1080p	23.97Hz/24Hz	16:9	1:1
33	1920x1080p	25Hz	16:9	1:1
34	1920x1080p	29.97Hz/30Hz	16:9	1:1
35	2880x480p	59.94Hz/60Hz	4:3	2:9, 4:9, or 8:9 <sup>4</sup>
36	2880x480p	59.94Hz/60Hz	16:9	8:27, 16:27, or 32:27 <sup>4</sup>
37	2880x576p	50Hz	4:3	4:15, 8:15, or 16:15 <sup>4</sup>
38	2880x576p	50Hz	16:9	16:45, 32:45, or 64:45 <sup>4</sup>
39	1920x1080i (1250 total)	50Hz	16:9	1:1

**Table 4 Video Formats—Video ID Code and Aspect Ratios**

VIC	Formats	Field Rate <sup>1</sup>	Picture Aspect Ratio (H:V) <sup>1</sup>	Pixel Aspect Ratio (H:V)
40	1920x1080i	100Hz	16:9	1:1
41	1280x720p	100Hz	16:9	1:1
42	720x576p	100Hz	4:3	16:15
43	720x576p	100Hz	16:9	64:45
44	720(1440)x576i	100Hz	4:3	16:15
45	720(1440)x576i	100Hz	16:9	64:45
46	1920x1080i	119.88/120Hz	16:9	1:1
47	1280x720p	119.88/120Hz	16:9	1:1
48	720x480p	119.88/120Hz	4:3	8:9
49	720x480p	119.88/120Hz	16:9	32:27
50	720(1440)x480i	119.88/120Hz	4:3	8:9
51	720(1440)x480i	119.88/120Hz	16:9	32:27
52	720x576p	200Hz	4:3	16:15
53	720x576p	200Hz	16:9	64:45
54	720(1440)x576i	200Hz	4:3	16:15
55	720(1440)x576i	200Hz	16:9	64:45
56	720x480p	239.76/240Hz	4:3	8:9
57	720x480p	239.76/240Hz	16:9	32:27
58	720(1440)x480i	239.76/240Hz	4:3	8:9
59	720(1440)x480i	239.76/240Hz	16:9	32:27
60	1280x720p	23.97Hz/24Hz	16:9	1:1
61	1280x720p	25Hz	16:9	1:1
62	1280x720p	29.97Hz/30Hz	16:9	1:1
63	1920x1080p	119.88/120Hz	16:9	1:1
64	1920x1080p	100Hz	16:9	1:1
65-127	Reserved for the Future			
0	No Video Identification Code Available (Used with AVI InfoFrame only)			

1. Picture Aspect Ratio—For example, with the 720x480 (16:9) data format and a 4:3 display, the source could (1) use pan and scan information to crop the data to 540 horizontal pixels and then resample up to the required 720 pixels for output to the display or (2) vertically resample to 360 lines and create bars of 60 lines above and below it to send this “letterbox” with the required 480 lines for output. Other picture scaling methods are possible in either source or sink. For example, picture aspect ratio scaling (picture expand, shrink, etc.) can be accomplished in the source, including, possibly, added black/gray lines in the pixel portion of the video. The exception to this is the 640x480 format, which is always sent as 4x3 data, and is rendered according to the characteristics of the sink.

2. The pixel repeat value can vary from 1 to 10 (see the PR field in Section 6.4) resulting in 10 variations of Pixel Aspect Ratio.

3. The pixel repeat value can vary from 1 to 2 (see the PR field in Section 6.4) resulting in 2 variations of Pixel Aspect Ratio.

4. The pixel repeat value can be 1, 2 to 4 (see the PR field in Section 6.4) resulting in 3 variations of Pixel Aspect Ratio.

**Table 4 Video Formats—Video ID Code and Aspect Ratios (Continued)**

<sup>1</sup> In the case of interlaced formats, the frame rate is 1/2 the field rate.



## 4.2 Frame Rate Relationships

Some video formats have a high frame rate that is an integer (2X, 4X, or 5X) multiple of the frame rate of a base (1X) video format. While receiving certain low frame rate video formats, some sources may calculate extra interpolated frames, and output a related high frame rate video format – in order to optimize display performance. Table 5 lists the VICs of base video formats along with the VICs of their higher frame rate counterparts.

Base (1X)	2X	4X	5X
2	48	56	
3	49	57	
4	47		
5	46		
6	50	58	
7	51	59	
17	42	52	
18	43	53	
19	41		
20	40		
21	44	54	
22	45	55	
32			63
33	31	64	
34	16		
60			47
61	19	41	
62	4	47	

**Table 5 Frame Rate Relationships—Base to High Frame Rate VICs**

## 5 Color Encoding, Sampling, & Conversion

### 5.1 Default Encoding Parameters

When present, encoding parameters specified in the AVI InfoFrame, or other interface-specific controls (e.g. HDMI General Control Packets), shall take precedence over any default parameters defined in this sub-section.

The default component depth shall be 8-bits (N=8). Other elements of the default parameter set vary as a function of video format timing type (IT or CE) and (in the case of CE video format timings) vertical active line count (Vactive).

When transmitting IT video format timings, the default color space shall be RGB using full range quantization levels. The RGB color space used for the transmission of IT video format timings should be the RGB color space the sink declares in the Basic Display Parameters and Feature Block of its EDID (see Sections A.2.6 and A.2.7 for further information). Most sources default to RGB color space when transmitting IT video format timings.

If a source determines that a sink is incapable of receiving AVI InfoFrames or is incapable of receiving YC<sub>B</sub>C<sub>R</sub> pixel data, then it shall, by default, encode the CE video format pixel data in RGB color space using limited quantization range levels. If a sink is incapable of receiving AVI InfoFrames, incapable of receiving YC<sub>B</sub>C<sub>R</sub> pixel data, or does not receive an AVI InfoFrame, then it should, by default, assume CE video format pixel data is encoded in RGB color space using limited quantization range levels and IT video format pixel data is encoded in RGB color space using full quantization range levels. In all cases described above, the RGB color space used should be the RGB color space the sink declares in the Basic Display Parameters and Feature Block of its EDID.

If a source determines that a sink is capable of receiving AVI InfoFrames and is capable of receiving  $Y_{CB}C_R$  pixel data, then it shall, by default, encode CE video format pixel data in a color space determined by the vertical active line count ( $V_{active}$ ) using limited quantization range levels. By default, an SD video format shall be encoded according to SMPTE 170M [1] color space and an HD video format shall be encoded according to ITU-R Rec. BT.709-5 [7] color space.

## 5.2 Color Component Samples

Color is communicated using one of two sets of components: RGB and  $Y_{CB}C_R$ <sup>2</sup>. This interface shall be capable of supporting RGB (red, green, and blue), with encoding parameters based on the format. The interface may optionally support  $Y_{CB}C_R$ .

### 5.2.1 RGB-to- $Y_{CB}C_R$ Conversion Matrices

A transformation between  $Y_{CB}C_R$  to RGB generally occurs within the DTV after it receives a  $Y_{CB}C_R$  encoded picture. A transformation between  $Y_{CB}C_R$  color component samples and RGB color component samples can be accomplished by applying one of two conversion matrices: ITU-R Rec. 601 [6] or ITU-R Rec. 709 [7]. The specific conversion matrix required depends on the Colorimetry and Extended Colorimetry fields in the AVI InfoFrame. The conversion matrix is either specified explicitly (i.e., the Colorimetry field is set to ITU-R BT.601 or ITU-R BT.709) or it is denoted in the subscript of the short name of the selected  $Y_{CB}C_R$  colorimetry. For example, the ITU-R BT.601 conversion matrix applied to  $sYCC_{601}$  or  $Adobe_{YCC601}$  color component samples results in RGB color component samples (both positive and negative).

The ITU-R BT.601-5 [6] Section 3.5 color space matrix is shown below for convenience.

$$\begin{aligned} Y' &= 0.299 R' + 0.587 G' + 0.114 B' \\ C_R' &= ((R' - Y') * 0.71327) \\ C_B' &= ((B' - Y') * 0.56433) \end{aligned}$$

The ITU-R BT.709-5 [7] color conversion matrix is shown below for convenience.

$$\begin{aligned} Y' &= 0.2126 R' + 0.7152 G' + 0.0722 B' \\ C_R' &= ((R' - Y') / 1.5748) \\ C_B' &= ((B' - Y') / 1.8556) \end{aligned}$$

Prime values are transformed levels in non-linear color space (see Transfer Characteristic section).

### 5.2.2 Sample Lattice

In order to improve color reproduction, the sample lattice for RGB and  $Y_{CB}C_R$  4:2:2 pixel data should conform to the ITU-R Rec. 709 [7] sampling lattice. The sample lattice for these pixel data encodings are described below for convenience:

- R, G, B, and Y components are orthogonal, line- and picture-repetitive. R, G, and B components are co-sited with each other.
- $C_B$  and  $C_R$  are orthogonal, line- and picture-repetitive co-sited with each other and with alternate Y samples (starting with the first active Y sample in a line).

---

<sup>2</sup> RGB signals have the same notation in the digital and analog domains. Typically, YCbCr notation is used for digital domains; and YPbPr is used for analog domains.

The sample lattice for YC<sub>B</sub>C<sub>R</sub> 4:4:4 pixel data should be the same as the sample lattice for RGB pixel data.

### 5.3 Transfer Characteristic (e.g. gamma correction)

The transfer characteristics for sRGB (as specified in IEC 61966-2-1 [34]) encoded images are shown below for convenience.

$$L' = 12.92 * L \text{ for } 0.0 \leq L < 0.0031308$$

$$L' = (1.055 * L^{(1.0/2.4)}) - 0.055 \text{ for } 0.0031308 \leq L \leq 1.000$$

Where:

- L is the normalized component level in the range of 0.0 to 1.0 inclusive.
- L' is the transformed (gamma corrected) component level.

The transfer characteristics for sYCC (as specified in IEC 61966-2-1/Amendment.1:2003 [35]) encoded images are shown below for convenience.

$$L' = -1.055 * L^{(1.0/2.4)} + 0.055 \text{ for } L < -0.0031308$$

$$L' = 12.92 * L \text{ for } -0.0031308 \leq L \leq 0.0031308$$

$$L' = 1.055 * L^{(1.0/2.4)} - 0.055 \text{ for } 0.0031308 < L$$

Where:

- L is the normalized component level. The lower and upper boundaries of this range may be less than 0.0 (negative) and greater than 1.0, respectively.
- L' is the transformed (gamma corrected) component level.

The transfer characteristics for ITU-R Rec. BT.709 [7] and ITU-R Rec BT.601 [6]<sup>3</sup> encoded images are shown below for convenience.

$$L' = 4.5 * L \text{ for } 0.0 \leq L < 0.018$$

$$L' = (1.099 * L^{(0.45)}) - 0.099 \text{ for } 0.018 \leq L \leq 1.000$$

Where:

- L is the normalized component level in the range of 0.0 to 1.0 inclusive.
- L' is the transformed (gamma corrected) component level.

The transfer characteristics of the image shall conform to IEC 61966-2-4 [5] when AVI InfoFrame Data Byte 2 indicates extended color gamut is used. The transfer characteristics for IEC 61966-2-4 [5] encoded images are shown below for convenience. Dynamic range compression of luminance components brighter than white (i.e., where L is greater than 1.0) should be avoided.

$$L' = (-1.099 * (-L)^{(0.45)}) + 0.099 \text{ for } L \leq -0.018$$

$$L' = 4.5 * L \text{ for } -0.018 < L < 0.018$$

$$L' = (1.099 * L^{(0.45)}) - 0.099 \text{ for } L \geq 0.018$$

Where:

- L is the normalized component level in a range defined by data transmitted in an interface specific way according to the capabilities of the sink, which are identified by EDID bits MD[3:0] (see

<sup>3</sup> ITU-R Rec. BT.601 [6] does not specify an actual transfer function, however, most DTVs are expected to be characterized to approximate the ITU-R Rec. BT.709 [7] transfer function.

section 7.5.5). The lower and upper boundaries of this range may be less than 0.0 (negative) and greater than 1.0, respectively.

- $L'$  is the transformed (gamma corrected) component level.

The transfer characteristics for Adobe<sub>YCC601</sub> and Adobe<sub>RGB</sub> (as specified in IEC 61966-2-5 [33]) encoded images are shown below for convenience.

$$L' = L^{(1.0/2.2)} \text{ for } 0 \leq L \leq 1.0$$

Where:

- $L$  is the normalized component level in the range of 0.0 to 1.0 inclusive.
- $L'$  is the transformed (gamma corrected) component level.

## 5.4 Color Coding & Quantization

**Component Depth:** The coding shall be N-bit, where N=8, 10, 12, or 16 bits/component - except in the case of the default 640x480 video timing 1, where the value of N shall be 8.

**Rounding:** code = Floor ( $X + 0.5$ ), where  $X$  is the result of a floating point calculation.

**Range:** Limited range R, G, B, and Y signals shall have  $(219 \cdot 2^{(N-8)}) + 1$  quantization levels. Limited range  $C_B$  and  $C_R$  signals shall have  $(224 \cdot 2^{(N-8)}) + 1$  quantization levels. Full range R, G, B, and Y signals shall have  $(255 \cdot 2^{(N-8)}) + 1$  quantization levels.

**Levels:** Limited range R, G, B, and Y signals shall have black level corresponding to code  $16 \cdot 2^{(N-8)}$  and the peak white level corresponding to code  $235 \cdot 2^{(N-8)}$ ; Limited range  $C_B$  and  $C_R$  signals shall have a zero level corresponding to digital code  $2^{(N-1)}$  and range spanning codes  $16 \cdot 2^{(N-8)}$  to  $240 \cdot 2^{(N-8)}$ .

**Overshoot/Undershoot Regions:** If the N-bit digital video signal is converted to an analog signal in the sink, it is recommended that for RGB or Y, the black level (i.e., sync level and blanking level) be aligned with the video portion of the signal at black and white digital levels  $16 \cdot 2^{(N-8)}$  and  $235 \cdot 2^{(N-8)}$ , respectively, such that the limited range digital signal swing corresponds to the nominal analog video swing (e.g. 0 to 700mV per sections 9.4, 10.5, and 10.6 of SMPTE 274M [2]). This means that zero analog level (0.0 IRE Units) should be associated with digital level  $16 \cdot 2^{(N-8)}$ . Digital levels in an undershoot region 1 to  $(16 \cdot 2^{(N-8)}) - 1$  and overshoot region  $(235 \cdot 2^{(N-8)}) + 1$  to  $(2^N) - 2$  are recommended to be passed through the digital to analog converter; however, limited range of the analog signal should be aligned with the range  $16 \cdot 2^{(N-8)}$  to  $235 \cdot 2^{(N-8)}$  since it is expected that this range contains essential video. For the 640x480p format, it is recommended that the full 0-255 range be displayed for this format.

**Forbidden Values:** For limited range R, G, B, Y,  $C_B$ ,  $C_R$  signals, codes 0 and  $(2^N) - 1$  are reserved and should not be considered video.

## 6 —Auxiliary Information Carried from Source to Sink

Various types of auxiliary data can be carried from the source to the sink using InfoFrames. This section describes the InfoFrames that have been defined so far.

The actual mechanism for carrying these InfoFrames may vary depending on the digital interface being used<sup>4</sup>.

---

<sup>4</sup> Neither DVI 1.0 [4] nor OpenLDI 0.95 [8] contain a mechanism for transporting InfoFrames. These physical interfaces can be used to implement this standard with reduced functionality. HDMI, which is backward compatible

Source and sinks shall not rely on the Revision Number in the CEA Extension of the sink's EDID to determine whether a sink can accept InfoFrames. Sinks shall declare InfoFrame capability by including an interface related (e.g. HDMI) VSDB in their EDID CEA Extension. Sources shall only assume InfoFrame capability, when an appropriate (e.g. HDMI) VSDB is found.

NOTE—Previous versions of CEA-861 relied on a Revision Number in the included CEA Extension to indicate whether the sink could accept InfoFrames. Due to a significant number of DVI (not InfoFrame-capable) sinks having the Revision Number set to 3, indicating support of InfoFrames, and not being capable of doing so, it is necessary to deprecate this requirement.

DVI does not support the transmission of any InfoFrames, independent of CEA Extension version number. Sinks with a VSDB indicating support for reception of InfoFrames shall accept any of the InfoFrames defined here.

Six types of InfoFrames are defined in CEA-861-E (Auxiliary Video Information InfoFrame, Vendor Specific InfoFrame, Source Product Description InfoFrame, Audio InfoFrame, MPEG Source InfoFrame, and NTSC VBI InfoFrame). The assigned type codes for these InfoFrames are shown in Table 6. The first byte of the InfoFrame designates the type of InfoFrame while the second byte indicates the version of that particular InfoFrame. All future versions of a specific InfoFrame shall be backward compatible with previous versions. They may contain additional information, but old and new devices should be able to access and interpret the information previously received.

Info Frame Type Code	Type of InfoFrame
0x00	Reserved
0x01	Vendor Specific (defined in Section 6.1)
0x02	Auxiliary Video Information (defined in Section 6.2)
0x03	Source Product Description (defined in Section 6.5)
0x04	Audio (defined in Section 6.6 of this document)
0x05	MPEG Source (defined in Section 6.7 of this document)
0x06	NTSC VBI (defined in Section 6.8 of this document)
0x07-0xFF	Reserved for future use

**Table 6 List of InfoFrame Type Codes**

The InfoFrame Length Field is contained in the third byte of each InfoFrame. This length field is the total number of bytes in the InfoFrame Payload. It does not include the Type, Version, or Length fields. In the case of the Vendor Specific InfoFrame, the length includes the IEEE Registration ID, also called "company\_id" or OUI, as well as any additional bytes defined by the vendor to be in the InfoFrame (see Table 7). If the InfoFrame Length field is not set correctly, sinks might not be able to parse the InfoFrame correctly.

The Vendor Specific InfoFrame is described in Section 6.1. The contents of the Auxiliary Video Information InfoFrame are described in Section 6.2. The contents of the Product Description InfoFrame are described in Section 6.5. The contents of the Audio InfoFrame are described in Section 6.6. The contents of the MPEG Source InfoFrame are described in Section 6.7. The contents of the NTSC VBI InfoFrame are described in Section 6.8.

### 6.1 Vendor Specific InfoFrames

The content of the Vendor Specific InfoFrame is defined in Table 7. This InfoFrame can be used by product manufacturers or organizations that have an assigned 24-bit IEEE Registration Identifier to transport information not defined elsewhere. The Vendor Specific Payload would be defined by the

---

with DVI 1.0 and contains mechanisms for transferring InfoFrames, digital audio, and YC<sub>B</sub>C<sub>R</sub> pixel data, is available and can be used to implement the full capabilities of CEA-861-E.

organization to which the 24-bit IEEE number refers. The 24-bit IEEE number is sent the least significant byte first. It is recommended that the Vendor Specific Payload contain a “length field” to facilitate extensibility, but this is not required.

Any organization or vendor that wishes to define a vendor specific InfoFrame shall obtain a registration ID (also known as vendor ID, organizationally unique ID or company ID) from the IEEE Registration Authority [71].

Byte #	Field Name	Contents
n	Vendor Specific InfoFrame Type Code	0x01
n+1	Vendor Specific InfoFrame Version	0x01
n+2	$L_V$ InfoFrame Length	Total number of bytes in InfoFrame Payload including IEEE Registration ID
n+3	24 bit IEEE Registration Identifier	24 bit IEEE Registration ID (Least Significant Byte first)
....		
n+5		
...	Vendor Specific Payload	Vendor Specific Payload
n+ $L_V$ -1		

**Table 7 Vendor Specific InfoFrame**

### 6.2 Auxiliary Video Information (AVI) InfoFrame

The Auxiliary Video Information (AVI) InfoFrame contains information that describes the pixel data carried in the next video field. It also contains information about the composition of the picture. Also see Section 7 for EDID requirements that relate to the processing of AVI InfoFrames in both source and sinks.

NOTE—Previous versions of CEA-861 defined the Version 1 AVI InfoFrame. Support for version 1 is not included in CEA-861-E.

Sources shall not use AVI InfoFrame version 1.

If the source supports the transmission of the Auxiliary Video Information (AVI) and if it determines that the sink is capable of receiving that information, it shall send the AVI to the sink once per video field. The data applies to the next full frame of video data.

A sink capable of receiving a video format with video identification code greater than 7 or capable of receiving dual-aspect ratio timing shall be able to receive and decode the AVI InfoFrame described in this Section. As required in Section 7.1, a sink declares the capability of receiving video formats generated at different picture aspect ratios by listing both video formats in its EDID data structure. Simultaneous support of timings available in two different aspect ratios shall be indicated by listing both formats in the EDID data structure at the same time.

If, for some reason, an indication is received that conflicts with the video format being received (e.g., the source indicates 4:3 but sends the 1920x1080i format), then the sink shall ignore the conflicting information in the AVI.

If a sink is capable of receiving  $Y_{C_B}C_R$  pixel data, then, as defined in Section 7.1, it is required to include the Version 3 CEA Extension in its EDID with at least one of the  $Y_{C_B}C_R$  chroma sampling format bits set. When a sink's EDID indicates that it is capable of receiving  $Y_{C_B}C_R$  pixel data the sink shall be capable of receiving AVI InfoFrames. If no AVI InfoFrame is sent from the source, then, as defined in Section 5.1, the sink is required to assume that all CE video formats are encoded in RGB color space using limited quantization range levels with an 8-bit component depth.

The information on “Active Format Aspect Ratio,” bar widths, overscan/underscan, non-uniform picture scaling, and colorimetry is information that can be used by the sink to improve the picture quality. Use of

this information by the sink is optional. If this information is present at the source and valid<sup>5</sup>, and if the sink is capable of receiving the AVI, the source shall send the information.

### 6.3 Format of Version 1 AVI InfoFrame

The Version 1 AVI InfoFrame was originally defined in a predecessor of CEA-861-E but not used. For historical purposes, the Version 1 AVI InfoFrame is shown in Table 8.

InfoFrame Type Code	InfoFrame Type = 0x02							
InfoFrame Version Number	Version = 0x01							
Length of AVI InfoFrame	Length of AVI InfoFrame (13)							
Data Byte 1	F17=0	Y1	Y0	A0	B1	B0	S1	S0
Data Byte 2	C1	C0	M1	M0	R3	R2	R1	R0
Data Byte 3	F37=0	F36=0	F35=0	F34=0	F33=0	F32=0	SC1	SC0
Data Byte 4	F47=0	F46=0	F45=0	F44=0	F43=0	F42=0	F41=0	F40=0
Data Byte 5	F57=0	F56=0	F55=0	F54=0	F53=0	F52=0	F51=0	F50=0
Data Byte 6	ETB07-ETB00 (Line Number of End of Top Bar – lower 8 bits)							
Data Byte 7	ETB15-ETB08 (Line Number of End of Top Bar – upper 8 bits)							
Data Byte 8	SBB07-SBB00 (Line Number of Start of Bottom Bar – lower 8 bits)							
Data Byte 9	SBB15-SBB08 (Line Number of Start of Bottom Bar - upper 8 bits)							
Data Byte 10	ELB07-ELB00 (Pixel Number of End of Left Bar – lower 8 bits)							
Data Byte 11	ELB15-ELB08 (Pixel Number of End of Left Bar – upper 8 bits)							
Data Byte 12	SRB07-SRB00 (Pixel Number of Start of Right Bar – lower 8 bits)							
Data Byte 13	SRB15-SRB08 (Pixel Number of Start of Right Bar – upper 8 bits)							

**Table 8 Auxiliary Video Information InfoFrame format (Version 1)**

### 6.4 Format of Version 2 AVI InfoFrame

The format of the Version 2 AVI InfoFrame is backward compatible with Version 1. All of the fields that were contained in the Version 1 AVI InfoFrame are also contained in the Version 2 AVI InfoFrame. Their purpose and use remain unchanged. All fields of the Version 2 AVI are described here. The Version 2 AVI InfoFrame is shown in Table 9.

<sup>5</sup> The data may not be valid if, for example, the stream was converted from an analog signal with no reliable aspect ratio or format information.

InfoFrame Type Code	InfoFrame Type = 0x02							
InfoFrame Version Number	Version = 0x02							
Length of AVI InfoFrame	Length of AVI InfoFrame (13)							
Data Byte 1	F17=0	Y1	Y0	A0	B1	B0	S1	S0
Data Byte 2	C1	C0	M1	M0	R3	R2	R1	R0
Data Byte 3	ITC	EC2	EC1	EC0	Q1	Q0	SC1	SC0
Data Byte 4	F47=0	VIC6	VIC5	VIC4	VIC3	VIC2	VIC1	VIC0
Data Byte 5	YQ1	YQ0	CN1	CN0	PR3	PR2	PR1	PR0
Data Byte 6	ETB07-ETB00 (Line Number of End of Top Bar – lower 8 bits)							
Data Byte 7	ETB15-ETB08 (Line Number of End of Top Bar – upper 8 bits)							
Data Byte 8	SBB07-SBB00 (Line Number of Start of Bottom Bar – lower 8 bits)							
Data Byte 9	SBB15-SBB08 (Line Number of Start of Bottom Bar – upper 8 bits)							
Data Byte 10	ELB07-ELB00 (Pixel Number of End of Left Bar – lower 8 bits)							
Data Byte 11	ELB15-ELB08 (Pixel Number of End of Left Bar – upper 8 bits)							
Data Byte 12	SRB07-SRB00 (Pixel Number of Start of Right Bar – lower 8 bits)							
Data Byte 13	SRB15-SRB08 (Pixel Number of Start of Right Bar – upper 8 bits)							

**Table 9 Auxiliary Video Information (AVI) InfoFrame Format (Version 2)**

Data Byte 1 (Table 10) contains bits that describe overscan/underscan (e.g., computer graphics or video), two bits to indicate the color component sample format and chroma sampling, and other bits to indicate the presence of active format and/or bar data. If the bar data and the active format information do not agree, then the bar data shall take precedence.

Data Byte 1, bits Y1, and Y0 set the color component sample format and chroma sampling format of the next picture. The source shall first determine if the sink is capable of receiving  $Y_C_B C_R$  pixel data in the defined chroma sampling format prior to sending such data. See Sections 7.1 and 7.4 for a description of a sink's support of  $Y_C_B C_R$  chroma sampling formats.

Data Byte 1, bit A0 indicates whether Active Format Data is present in Data Byte 2 bits R3 through R0. A source device shall set A0=1 when any of the AFD bits are set.

Data Byte 1, bits B1, and B0 indicate the presence and type of bar data transmitted in Data Bytes 6 through 13. The contents of Data Bytes 6 through 13 are described later in this Section. The presence of both vertical and horizontal bar data is not standardized.



F7	Future Use, all Zeros	Y1	Y0	RGB or YC <sub>B</sub> C <sub>R</sub>	A0	Active Format Information Present	B1	B0	Bar Data Present	S1	S0	Scan Information
0		0	0	RGB (default)	0	No Active Format Information	0	0	Bar Data not present	0	0	No Data
		0	1	YC <sub>B</sub> C <sub>R</sub> 4:2:2	1	Active Format (R3...R0) Information present	0	1	Vert. Bar Info present	0	1	Composed for an overscanned display, where some active pixels and lines at the edges are not displayed.
		1	0	YC <sub>B</sub> C <sub>R</sub> 4:4:4			1	0	Horiz. Bar Info present	1	0	Composed for an underscanned display, where all active pixels & lines are displayed, with or without a border.
		1	1	Future			1	1	Vert. and Horiz. Bar Info present	1	1	Future

Table 10 AVI InfoFrame Data Byte 1

Data Byte 1, bits S1, and S0 contain information that defines the picture composition of the next video field. A source shall set S=1 (S1=0, S0=1) or S=2 (S1=1, S0=0) if it is confident of the accuracy of those values. Otherwise, it shall set S=0 (no data). The source shall follow these rules for setting S even in the absence of an indication that the sink responds to the value of S.

Data Byte 2, bits M1, and M0 contain the Picture Aspect Ratio. If M=0 (M1=0, M0=0), a sink shall assume the picture is formatted according to the preferred picture aspect ratio.

A sink should adjust its scan based on the value of S. A sink would overscan if it received S=1, and underscan if it received S=2. If it receives S=0, then it should overscan for a CE video format and underscan for an IT video format. A sink should indicate its overscan/underscan behavior using a Video Capabilities Data Block (see Section 7.5.6).

Data Byte 2 (Table 11) contains bits that describe colorimetry, picture aspect ratio, and active format information.

Data Byte 2, C0, and C1 are used in conjunction with Data Byte 3, EC0 through EC2 to override the default color spaces and explicitly indicate the colorimetry of the next picture. If bits C0 and C1 are zero, the colorimetry shall correspond to the default colorimetry defined in Section 5.1. A source shall be prohibited from setting C=1 (C1=0, C0=1) or C=2 (C1=1, C0=0) when Y=0 (Y1=0, Y0=0) in Data Byte 1. C=3 shall be reserved for future use.

C1	C0	Colorimetry	M1	M0	Coded Frame Aspect Ratio	R3	R2	R1	R0	Active Portion Aspect Ratio
0	0	No Data	0	0	No Data	1	0	0	0	Same as coded frame aspect ratio
0	1	SMPTE 170M [1]	0	1	4:3	1	0	0	1	4:3 (Center)
1	0	ITU-R 709 [7]	1	0	16:9	1	0	1	0	16:9 (Center)
1	1	Extended Colorimetry Information Valid (colorimetry indicated in bits EC0, EC1, EC2. See Table 11)	1	1	Future	1	0	1	1	14:9 (Center)
other values										Varies. See Annex H.

**Table 11 AVI InfoFrame Data Byte 2**

Table 12 illustrates the terminology and examples of common aspect ratio information that can be communicated from a source to a display device using CEA-861-E. It illustrates some of the possibilities for the two standard picture aspect ratios (4:3 and 16:9) within the coded frame. The “active format” codes shall be transmitted when received with content. Originating devices supplying such codes may provide codes in accordance with the Active Format Description<sup>6</sup> (AFD) in ETSI TS 101 154 [47]. All of the active format codes defined in [47] are reproduced in informative Annex H.

<sup>6</sup> Note that the use of the word “active” in the “Active Format Description” differs from how it is used in other places of this standard and documents referenced by this standard. The word, “active” usually refers to all active pixels. In this case of AFD, the word, “active” refers only to the area containing content pixels and its format relative to areas potentially containing bar pixels.

active_format	Description			
	4:3 coded frames		16:9 coded frames	
'1000'	4:3 full frame image		16:9 full frame image	
'1001'	4:3 full frame image		4:3 pillarbox image	
'1010'	16:9 letterbox image		16:9 full frame image	
'1011'	14:9 letterbox image		14:9 pillarbox image	

Table 12 Common Active Formats

See CEA-CEB16 [46] for more information about AFD processing.

Data Byte 3 is divided into four fields as shown in Table 13.

ITC	IT content	EC2	EC1	EC0	Extended Colorimetry	Q1	Q0	RGB Quantization Range	SC1	SC0	Non-Uniform Picture Scaling
0	No data	0	0	0	xvYCC <sub>601</sub>	0	0	Default (depends on video format)	0	0	No Known non-uniform Scaling
1	IT content (Byte 5 CN bits valid)	0	0	1	xvYCC <sub>709</sub>	0	1	Limited Range	0	1	Picture has been scaled horizontally
		0	1	0	sYCC <sub>601</sub>	1	0	Full Range	1	0	Picture has been scaled vertically
		0	1	1	Adobe <sub>YCC601</sub>	1	1	Reserved	1	1	Picture has been scaled horizontally and vertically
		1	0	0	Adobe <sub>RGB</sub> All other values reserved						

Table 13 AVI InfoFrame Data Byte 3

Bits SC1 and SC0 provide information on whether the picture has been scaled in a non-uniform way (i.e., unequal along horizontal and vertical dimensions) prior to transmission to the sink. The Non-uniform Picture Scaling bits shall be set if the source scales the picture or has determined that scaling has been performed in a specific direction. If the picture has been stretched or shrunk in a uniform way (i.e., equally along both dimensions), then the bits should not be set. These bits are present to help avoid situations such as the one illustrated in Annex I.

Displays conforming to CEA-861-E accept both limited and full range quantization range pixel data when receiving pictures encoded in an RGB color space. The quantization bits in Data Byte 3, bits Q1 and Q0 allow the source to override the default RGB quantization range and to explicitly indicate the RGB quantization range of the next picture. The value Q=0 (Q1=0, Q0=0) indicates that the quantization range corresponds to the default RGB quantization range defined in Section 5.1. A source shall not send a non-zero Q value that does not correspond to the default RGB quantization range for the transmitted picture unless the sink indicates support for the Q bit in a Video Capabilities Data Block (see Section 7.5.6).

The IT content bit indicates when picture content is directly composed according to common IT practices or derived from a specific type of IT content. When the IT content bit is set to 1, downstream processors should process pixel data according to the setting of the content type bits CN1 and CN0 of Byte 5.

The following rules apply to the ITC flag: if ITC = 0, the Content flags (CN0, CN1) should be ignored; if ITC = 1, the Content flags (CN0, CN1) are valid and shall be interpreted according Table 16.

	RGB or Y <sub>C</sub> B <sub>C</sub> R <sub>R</sub> (from Data Byte 1)		Colorimetry (from Data Byte 2)		Extended Colorimetry (from Data Byte 3)			Colorimetry of Next Transmitted Picture	Notes
	Y1	Y0	C1	C0	EC2	EC1	EC0		
RGB 4:4:4	0	0	0	0	X	X	X	RGB	1
	0	0	0	1	X	X	X	Reserved	
	0	0	1	0	X	X	X	Reserved	
	0	0	1	1	0	X	X	Reserved	
	0	0	1	1	1	0	0	Adobe <sub>RGB</sub>	2
	0	0	1	1	1	0	1	Reserved	
	0	0	1	1	1	1	0	Reserved	
Y <sub>C</sub> B <sub>C</sub> R <sub>R</sub> 4:2:2	0	1	0	0	X	X	X	SMPTE 170M [1] or ITU-R Rec. BT.709 [7]	3,4
	0	1	0	1	X	X	X	SMPTE 170M [1]	4
	0	1	1	0	X	X	X	ITU-R Rec. BT.709 [7]	4
	0	1	1	1	0	0	0	xvYCC <sub>601</sub>	2,4
	0	1	1	1	0	0	1	xvYCC <sub>709</sub>	2,4
	0	1	1	1	0	1	0	sYCC <sub>601</sub>	2,4
	0	1	1	1	0	1	1	Adobe <sub>YCC601</sub>	2,4
Y <sub>C</sub> B <sub>C</sub> R <sub>R</sub> 4:4:4	1	0	0	0	X	X	X	SMPTE 170M [1] or ITU-R Rec. BT.709 [7]	3,4
	1	0	0	1	X	X	X	SMPTE 170M [1]	4
	1	0	1	0	X	X	X	ITU-R Rec. BT.709 [7]	4
	1	0	1	1	0	0	0	xvYCC <sub>601</sub>	2,4
	1	0	1	1	0	0	1	xvYCC <sub>709</sub>	2,4
	1	0	1	1	0	1	0	sYCC <sub>601</sub>	2,4
	1	0	1	1	0	1	1	Adobe <sub>YCC601</sub>	2,4
Future	1	1	X	X	X	X	X	Reserved	
<b>Notes:</b>									
1. A DTV declares it is capable of displaying pictures encoded in sRGB color space (as defined in IEC 61996-2-1 [34]) by setting bit 2 in the Feature Support byte (0x18) of the Basic Display Parameters and Feature Block in its EDID. A sink that declares it is not capable of displaying pictures encoded in RGB color space declares its colorimetry via the values set in bytes 0x19 through 0x22 of the Basic									

Display Parameters and Feature Block in its EDID. See sections A.2.6 and A.2.7 for further information.

2. A DTV declares it is capable of displaying pictures encoded in this colorimetry by setting the associated bit in Byte 3 of the Colorimetry Data Block in its EDID. See section 7.5.5 for further information.

3. The picture colorimetry is dependent on the value of Vactive for the Video Identification Code set in the AVI InfoFrame. See Section 5 for further information.

4. A DTV declares it is capable of displaying pictures encoded in this colorimetry by setting bit 4 and/or bit 5 in Byte 3 of the CEA Extension Version 3 block in its EDID. See section 7.5.

**Table 14 Picture Colorimetry Indicated by the RGB or YC<sub>B</sub>C<sub>R</sub> (Y), Colorimetry (C) and Extended Colorimetry (EC) Field Settings**

Bits 0 through 6 of byte 4 contain a Video Identification Code (VIC). In most cases, the video format can be uniquely determined from the video format timing itself. However, if the source is sending one of the video formats defined in this document, then it shall set this field to the proper code. If a video format not listed in CEA-861-E is sent, then the Video Identification Code shall be set to 0. If this field is used and if it is inconsistent with the video format being received, then it shall be ignored by the sink. If the picture aspect ratio implied by this field does not agree with the picture aspect ratio communicated in Data Byte 2, then Data Byte 2 shall take precedence. The codes associated with each video format are shown in Table 4. These same codes are used in the Short Video Descriptors used in the Version 3 CEA Extension, which is described in Section 7.5. If the source needs to convey “no information” regarding the video format (perhaps it is sending a proprietary format that was defined using the EDID Detailed Timing Descriptor in the sink), then this field shall be set to 0.

Data Byte 5 contains the pixel repetition field (PR). The first transmitted active pixel of an active line shall be unique. When PR is zero, the second through the last transmitted active pixel shall each be unique. When PR is greater than zero, unique active pixels are transmitted less often as the source shall repeat each unique active pixel PR-times. Unique active pixels are always vertically aligned and horizontally spaced at PR+1 active pixel (clock) intervals. The values for PR are shown in Table 15.

When Photo content is sent by the source, Byte 5 Content bits CN1 and CN0 shall be set to Photo (CN1=0 and CN0=1), this setting shall be used in conjunction with Byte 4 to indicate the color space for Photo content which is either sYCC<sub>601</sub>, Adobe<sub>YCC601</sub>, or Adobe<sub>RGB</sub>.

PR3	PR2	PR1	PR0	Pixel Repetition Factor (PR+1)
0	0	0	0	No Repetition (i.e., pixel data sent once)
0	0	0	1	pixel data sent 2 times (i.e., repeated once)
0	0	1	0	pixel data sent 3 times
0	0	1	1	pixel data sent 4 times
0	1	0	0	pixel data sent 5 times
0	1	0	1	pixel data sent 6 times
0	1	1	0	pixel data sent 7 times
0	1	1	1	pixel data sent 8 times
1	0	0	0	pixel data sent 9 times
1	0	0	1	pixel data sent 10 times
0x0A-0x0F				Reserved

**Table 15 AVI InfoFrame Pixel Repetition Field, Data Byte 5**

A source shall correctly set the PR field whenever it sends an AVI InfoFrame to a sink – no matter what video timing format is being transmitted. A list of allowable PR values for each CE video format is shown in Table 18. Note that this characteristic is independent of Picture Aspect Ratio. When a source outputs a

video timing format with non-repeated pixels, PR shall be set to 0. When a source outputs a double-clocked video timing format, PR shall be set to 1. When a source outputs video timing formats 10 through 15, 25 through 30, or 35 through 38, it shall send an AVI InfoFrame indicating the specific PR being used and the sink shall properly interpret it – decimating or repeating pixels depending on the signal process.

Video timing formats with Video Identification Codes 10 through 15, 25 through 30, and 35 through 38 support variable horizontal resolution. These video formats maintain a fixed 1440- or 2880-pixel Hactive and use pixel repetition to, in effect, provide different horizontal resolutions.

Video formats with video identification codes 10 through 13 and 25 through 28 keep Hactive fixed at 2880 pixels and allow PR to be varied over a 10-to-1 range thereby providing effective resolutions of 288, 320, 360, 411, 480, 576, 720, 960, 1440, and 2880 unique active pixels per video line, respectively. In addition, gaming formats typically utilize optional left and right bars, which insure that all of the pixels in a game are visible on overscanned displays and further reduce the number of content pixels to 256, 284, 320, 366, 427, 512, 640, 853, 1280, and 2560 pixels, respectively. When Hactive is not an integer multiple of PR+1, the source shall adjust the sidebars so that the width of the left bar is an integer multiple of PR+1 and the right bar begins with a unique active pixel. Table 19 gives recommended bar placement for each value of PR in the form of AVI bar data.

Video formats with video identification codes 14, 15, 29, and 30 allow PR to be set to 2 or 1 thereby providing effective resolutions of 720 or 1440 unique active pixels per video line, respectively.

Video formats with video identification codes 35 through 38 allow PR to be set to 4, 2, or 1 thereby providing effective resolutions of 720, 1440, or 2880 unique active pixels per video line, respectively.

The extended colorimetry bits, EC2, EC1, and EC0, describe optional colorimetry encoding that may be applicable to some implementations. The sink shall interpret the Y, C, and EC fields of Data Bytes 1, 2 and 3 according to Table 14. A value of 'X' in the table indicates the bit shall be ignored by the sink. A reserved value in the table means the colorimetry assumed by the sink is indeterminate. Sources shall be prohibited from setting reserved colorimetries.

CN1	CN0	IT Content Type
0	0	Graphics
0	1	Photo
1	0	Cinema
1	1	Game

**Table 16 AVI Info Frame IT Contents Type, Data Byte 5**

Table 16 illustrates the meaning of Data Byte 5 Content Type bits CN1 and CN0. These bits should be used to signal delivery of IT content that is either classified as Graphics, Photo, Cinema, or Game.

The Graphics type is indicated by the source to flag content composed according to common IT practice (i.e. without regard to Nyquist criterion) and is unsuitable for analog reconstruction or filtering. In IT applications (e.g. involving bit mapped text), each pixel in the source's frame buffer is most clearly displayed if it is directly mapped to a light-emitting pixel on the display device - such that adjacent pixels are completely independent and do not interact. When the IT content bit is set to 1 and the Graphics type is indicated, downstream processors should pass pixel data unfiltered and without analog reconstruction.

The Photo type is indicated by the source to flag content derived from digital still pictures; sources may be a digital still camera, DVD player or other device. When the Photo type is indicated, an additional flag for Extended Colorimetry should correctly account for the content's color space. When the IT content bit is set to 1 and the Photo type is indicated, the sink is expected to "pass through" still pictures with minimal scaling and picture enhancement in order to avoid undesirable artifacts. The Photo type should not be associated with device type. For example, digital still cameras may support delivery of video.

The Cinema type is indicated by the source to flag content derived from cinema material. Audio may be processed through an audio video amplifier (AV Amp) or digital television. When the IT content bit is set to 1 and the Cinema type is indicated, the sink should “pass through” cinema content with minimal scaling and picture enhancement in order to avoid undesirable artifacts. The Cinema type should not be associated with device type. For example, DVD players are capable of supplying various content types such as TV programs.

The Game type is indicated by the source to flag content derived from game machine material. When the IT content bit is set to 1 and the Game type is indicated, the sink should “pass through” game content with minimal scaling and picture enhancement in order to avoid undesirable artifacts. Audio and video latency should also be minimized. The Game type should not be associated with device type. For example, game machines are capable of supplying various content types such as DVD movies.

YQ1	YQ0	YCC Quantization Range
0	0	Limited Range
0	1	Full Range
1	0	Reserved
1	1	Reserved

**Table 17 AVI Info Frame YCC Quantization Range, Data Byte 5**

Table 17 illustrates the meaning assigned to the YCC Quantization Range bits YQ1 and YQ0 in Data Byte 5.

VIC	Video Description	Valid Pixel Repeat Values	AVI w/PR Required
1	640x480p @ 59.94/60Hz	No Repetition	No
2, 3	720x480p @ 59.94/60Hz	No Repetition	No
4	1280x720p @ 59.94/60Hz	No Repetition	No
5	1920x1080i @ 59.94/60Hz	No Repetition	No
6, 7	720(1440)x480i @ 59.94/60Hz	pixel data sent 2 times	No
8, 9	720(1440)x240p @ 59.94/60Hz	pixel data sent 2 times	No
10, 11	2880x480i @ 59.94/60Hz	pixel data sent 1 to 10 times	Yes
12, 13	2880x240p @ 59.94/60Hz	pixel data sent 1 to 10 times	Yes
14, 15	1440x480p @ 59.94/60Hz	pixel data sent 1 to 2 times	Yes
16	1920x1080p @ 59.94/60Hz	No Repetition	No
17, 18	720x576p @ 50Hz	No Repetition	No
19	1280x720p @ 50Hz	No Repetition	No
20	1920x1080i @ 50Hz	No Repetition	No
21, 22	720(1440)x576i @ 50Hz	pixel data sent 2 times	No
23, 24	720(1440)x288p @ 50Hz	pixel data sent 2 times	No
25, 26	2880x576i @ 50Hz	pixel data sent 1 to 10 times	Yes
27, 28	2880x288p @ 50Hz	pixel data sent 1 to 10 times	Yes
29, 30	1440x576p @ 50Hz	pixel data sent 1 or 2 times	Yes
31	1920x1080p @ 50Hz	No Repetition	No
32	1920x1080p @ 23.98/24Hz	No Repetition	No
33	1920x1080p @ 25Hz	No Repetition	No
34	1920x1080p @ 29.98/30Hz	No Repetition	No
35, 36	2880x480p @ 59.94/60Hz	pixel data sent 1, 2 or 4 times	Yes
37, 38	2880x576p @ 50Hz	pixel data sent 1, 2 or 4 times	Yes
39	1920x1080i (1250) @ 50Hz	No Repetition	No
40	1920x1080i @ 100Hz	No Repetition	No
41	1280x720p @ 100Hz	No Repetition	No
42	720x576p @ 100Hz	No Repetition	No
43	720x576p @ 100Hz	No Repetition	No
44	720(1440)x576i @ 100Hz	pixel data sent 2 times	No
45	720(1440)x576i @ 100Hz	pixel data sent 2 times	No
46	1920x1080i @ 119.88/120Hz	No Repetition	No
47	1280x720p @ 119.88/120Hz	No Repetition	No
48	720x480p @ 119.88/120Hz	No Repetition	No
49	720x480p @ 119.88/120Hz	No Repetition	No
50	720(1440)x480i @ 119.88/120Hz	pixel data sent 2 times	No
51	720(1440)x480i @ 119.88/120Hz	pixel data sent 2 times	No
52	720x576p @ 200Hz	No Repetition	No
53	720x576p @ 200Hz	No Repetition	No
54	720(1440)x576i @ 200Hz	pixel data sent 2 times	No
55	720(1440)x576i @ 200Hz	pixel data sent 2 times	No
56	720x480p @ 239.76/240Hz	No Repetition	No
57	720x480p @ 239.76/240Hz	No Repetition	No
58	720(1440)x480i @ 239.76/240Hz	pixel data sent 2 times	No
59	720(1440)x480i @ 239.76/240Hz	pixel data sent 2 times	No
60	1280x720p @ 23.97Hz/24Hz	No Repetition	No
61	1280x720p @ 25Hz	No Repetition	No
62	1280x720p @ 29.97Hz/30Hz	No Repetition	No
63	1920x1080p @ 119.88Hz/120Hz	No Repetition	No
64	1920x1080p @ 100Hz	No Repetition	No

**Table 18 Valid Pixel Repeat Values for Each Video Format Timing**



Unique Active Pixel Spacing (in video pixels)	Unique Active Pixels	Unique Content Pixels	AVI PR	AVI B	AVI ELB	AVI SRB
1	2880	2560	0	1	160	2721
2	1440	1280	1	1	160	2721
3	960	853	2	1	162	2722
4	720	640	3	1	160	2721
5	576	512	4	1	160	2721
6	480	427	5	1	162	2725
7	411	366	6	1	161	2724
8	360	320	7	1	160	2721
9	320	284	8	1	162	2719
10	288	256	9	1	160	2721

**Table 19 Typical Gaming Format AVI InfoFrame Parameters**

Line counts shall be per SMPTE 2016-1 [36], Table 2, informatively reproduced in **Table 20**. The packets and bits are defined in **Table 20**.

Format	Applicable Standard	Coding Range Pixels x lines	Coded Pixels	Coded Lines		
				Field 1	Field 2	Frame
480 Interlaced	SMPTE 125M [41]	720 x 480	0 – 719	23 – 262	286 -525	-
480 Progressive	SMPTE 293M [39]	720 x 480	0 – 719	-	-	45 – 524
576 Interlaced	ITU-R BT.656 [54]	720 x 576	0 – 719	23 – 310	336 – 623	-
576 Progressive	ITU-R BT.1358 [56]	720 x 576	0 – 719	-	-	45 – 620
720 Progressive	SMPTE 296M [40]	1280 x 720	0 – 1279	-	-	26 – 745
1080 Interlaced	SMPTE 274M [2]	1920 x 1080	0 – 1919	21 – 560	584 – 1123	-
1080 Progressive	SMPTE 274M [2]	1920 x 1080	0 – 1919	-	-	42 – 1121

**Table 20 Video Format Information (Informative)**

Data Bytes 6 through 13 contain the location data for bars. These 8 bytes are present in the AVI whether or not they contain the bar data. For the purposes of the Line Number and the Pixel Number, the pixel in the upper left hand corner of the picture is considered to be in row 1, column 1. Lines and pixels are numbered consecutively as they would appear on a display.<sup>7</sup> All of the values are unsigned integers.

- a) **Line Number of End of Top Bar (ETB)** — An unsigned integer value representing the last line of a horizontal letterbox bar area at the top of the picture. Zero means no horizontal bar is present at the top of the picture.
- b) **Line Number of Start of Bottom Bar (SBB)** — An unsigned integer value representing the first line of a horizontal letterbox bar area at the bottom of the picture. If greater than the Maximum Vertical Active Lines of the known format, no horizontal bar is present at the bottom of the picture.
- c) **Pixel Number of End of Left Bar (ELB)** — An unsigned integer value representing the last horizontal pixel of a vertical pillar-bar area at the left side of the picture. Zero means no vertical bar is present on the left of the picture.
- d) **Pixel Number of Start of Right Bar (SRB)** — An unsigned integer value representing the first horizontal pixel of a vertical pillar-bar area at the right side of the picture. If greater than the Maximum Horizontal Pixels of the known format, no vertical bar is present on the right side of the picture.

<sup>7</sup> In this context, line numbers are not the same as the line numbers used in timing diagrams.

### 6.5 Source Product Description (SPD) InfoFrame

The Source Product Description (SPD) InfoFrame communicates the name and product type of the source. This allows the user to see which device is being selected when changing inputs on the sink.

Support of the SPD InfoFrame in the sink is indicated by including an appropriate VSDB in the sink's EDID data structure. The transmission of this InfoFrame is optional for the source. The use of the information by the sink is also optional. It shall not be sent more than once per video frame. If used, it is recommended that it be sent once every second.

The format of the Source Product Description InfoFrame is shown in Table 21.

InfoFrame Type Code	InfoFrame Type = 0x03	
InfoFrame Version Number	Version = 0x01	
Length of Source Product Description InfoFrame	Length of Source Product Description InfoFrame = 25	
Data Byte 1	0	Vendor Name Character 1 VN1 (7bit ASCII code)
Data Byte 2	0	Vendor Name Character 2 VN2
Data Byte 3	0	Vendor Name Character 3 VN3
Data Byte 4	0	Vendor Name Character 4 VN4
Data Byte 5	0	Vendor Name Character 5 VN5
Data Byte 6	0	Vendor Name Character 6 VN6
Data Byte 7	0	Vendor Name Character 7 VN7
Data Byte 8	0	Vendor Name Character 8 VN8
Data Byte 9	0	Product Description Character 1 PD1 (7-bit ASCII code)
Data Byte 10	0	Product Description Character 2 PD2
Data Byte 11	0	Product Description Character 3 PD3
Data Byte 12	0	Product Description Character 4 PD4
Data Byte 13	0	Product Description Character 5 PD5
Data Byte 14	0	Product Description Character 6 PD6
Data Byte 15	0	Product Description Character 7 PD7
Data Byte 16	0	Product Description Character 8 PD8
Data Byte 17	0	Product Description Character 9 PD9
Data Byte 18	0	Product Description Character 10 PD10
Data Byte 19	0	Product Description Character 11 PD11
Data Byte 20	0	Product Description Character 12 PD12
Data Byte 21	0	Product Description Character 13 PD13
Data Byte 22	0	Product Description Character 14 PD14
Data Byte 23	0	Product Description Character 15 PD15
Data Byte 24	0	Product Description Character 16 PD16
Data Byte 25	<b>Source Information</b>	

**Table 21 Source Product Description InfoFrame Format**

The Vendor Name consists of eight 7-bit ASCII characters. The name should be left justified (i.e., first character in Data Byte 1) and all unused characters should be Null (i.e., 0x00). The Vendor Name is intended to be the name of the company whose name appears on the product. The Product Description (contained in Data Bytes 9-24) consists of sixteen 7-bit ASCII characters. This code is meant to be the model number of the product and may contain a short description also (e.g., RC5240 DVD Player). Data Byte 25 consists of a code that classifies the source. Codes for the most common types of sources are shown in Table 22.

Code	Source Information
0x00	unknown
0x01	Digital STB
0x02	DVD player
0x03	D-VHS
0x04	HDD Videorecorder
0x05	DVC
0x06	DSC
0x07	Video CD
0x08	Game
0x09	PC general
0x0A	Blu-Ray Disc (BD)
0x0B	Super Audio CD
0x0C	HD DVD
0x0D	PMP
0x0E	Reserved
...	
0xFF	

**Table 22 Source Product Description InfoFrame Data Byte 25**

### 6.6 Audio InfoFrame

The Audio InfoFrame contains information that allows for the format of the digital audio streams to be identified more quickly via out-of-band information and, for multi-channel uncompressed audio (which does not otherwise give such information), provides channel allocation information for the sink's speakers. The Audio InfoFrame format is shown in Table 23.

If the sink supports any digital audio, it shall be capable of receiving the Audio InfoFrame and also capable of interpreting the audio identification information in Data Bytes 1-3. Support for digital audio other than basic audio is indicated in the Version 3 (or higher) CEA Extension (see Section 7.5). If the sink supports multi-channel (i.e., more than 2 channels) digital audio and has included speaker placement information in EDID (see Section 7.5), it shall be able to interpret the speaker channel assignment information and down-mix information in Data Bytes 4 & 5.

If the source supports the transmission of the Audio InfoFrame and if it determines that the sink is capable of receiving the Audio InfoFrame (i.e., the sink has included CEA Extension Version 3 in EDID) and digital audio, then the Audio InfoFrame, with Data Bytes 1 through 3 set correctly, shall be sent once per video field while digital audio is being sent across the interface. The data applies to the audio associated with the next full frame of video data.

If the source is sending multi-channel uncompressed audio, then it shall also send valid speaker channel allocation information and down-mix information in Data Bytes 4 & 5 of this InfoFrame.

InfoFrame Type Code	InfoFrame Type = 0x04							
InfoFrame Version Number	Version = 0x01							
Length of Audio InfoFrame	Length of Audio InfoFrame = 10							
Data Byte 1	CT3	CT2	CT1	CT0	F13=0	CC2	CC1	CC0
Data Byte 2	F27=0	F26=0	F25=0	SF2	SF1	SF0	SS1	SS0
Data Byte 3	F37=0	F36=0	F35=0	CXT4	CXT3	CXT2	CXT1	CXT0
Data Byte 4	CA7	CA6	CA5	CA4	CA3	CA2	CA1	CA0
Data Byte 5	DM_INH	LSV3	LSV2	LSV1	LSV0	F52=0	LFEPBL1	LFEPBL0
Data Byte 6	F67=0	F66=0	F65=0	F64=0	F63=0	F62=0	F61=0	F60=0
Data Byte 7	F77=0	F76=0	F75=0	F74=0	F73=0	F72=0	F71=0	F70=0
Data Byte 8	F87=0	F86=0	F85=0	F84=0	F83=0	F82=0	F81=0	F80=0
Data Byte 9	F97=0	F96=0	F95=0	F94=0	F93=0	F92=0	F91=0	F90=0
Data Byte 10	F107=0	F106=0	F105=0	F104=0	F103=0	F102=0	F101=0	F100=0

Table 23 Audio InfoFrame Format

### 6.6.1 Audio Identification Information

The information in Data Bytes 1-3 may be useful in identifying the audio format, audio channel count, audio sampling frequency, and number of bits per audio sample. If the DTV and the source support more than “basic audio,” as defined by the physical/link specification, then this information shall be sent and shall accurately identify the stream while digital audio is being sent. If the source only supports basic audio, it is not required to send this information, but it is recommended. In most cases, it is possible to identify the audio by parsing the actual audio stream (e.g., as specified in IEC 60958-3 [13]). In cases where the audio information in the Audio InfoFrame does not agree with the actual audio stream being received, the conflicting information in the Audio InfoFrame shall be ignored.

NOTE—HDMI requires the CT, SS, and SF fields to be set to 0 (“Refer to Stream Header”) when these items are indicated elsewhere. By extension the CXT field is also required to be set to 0.

Data Byte 1 bits CT3, CT2, CT1, and CT0, when coded, define the audio format type of the audio stream. These bits may be set according to Table 24. A sink capable of receiving digital audio shall determine the audio format by parsing the audio stream header when CT=0 (CT3=0, CT2=0, CT1=0, CT0=0). Audio format types shall be defined by the CXT field in Data Byte 3 when CT=15 (CT3=1, CT2=1, CT1=1, CT0=1).

Data Byte 1, bits CC2, CC1, and CC0, when coded, indicate the audio channel count carried transmitted in the audio stream. These bits may be set according to Table 24. When CC=0 (CC2=0, CC1=0, CC0=0) a sink capable of receiving digital audio over the interface shall determine the audio channel count by parsing the audio stream header.

C T 3	C T 2	C T 1	C T 0	Audio Coding Type	Audio Stream Encoding Standard	Audio Stream Transport Standard	C C 2	C C 1	C C 0	Audio Channel Count				
0	0	0	0	Refer to Stream Header							0	0	0	Refer to Stream Header
0	0	0	1	PCM	IEC 60958-3 [13]						0	0	1	2 channels
0	0	1	0	AC-3	ATSC A/52B [12], excluding Annex E	IEC 61937-3 [15]	0	1	0	3 channels				
0	0	1	1	MPEG-1	ISO/IEC 11172-3 [22] Layer 1 or Layer 2	IEC 61937-4 [16]	0	1	1	4 channels				
0	1	0	0	MP3	ISO/IEC 11172-3 [22] Layer 3	IEC 61937-4 [16]	1	0	0	5 channels				
0	1	0	1	MPEG2	ISO/IEC 13818-3 [23]	IEC 61937-4 [16]	1	0	1	6 channels				
0	1	1	0	AAC LC	ISO/IEC 14496-3 [24]	IEC 61937-6 [18]	1	1	0	7 channels				
0	1	1	1	DTS	ETSI TS 102 114 [37]	IEC 61937-5 [17]	1	1	1	8 channels				
1	0	0	0	ATRAC	IEC 61909 [14]. See also ATRAC [61]	IEC 61937-7 [19]								
1	0	0	1	DSD	ISO/IEC 14496-3 [24], subpart 10, See also Super Audio CD [70].									
1	0	1	0	E-AC-3	ATSC A/52B [12], with Annex E	IEC 61937-3 [15]								
1	0	1	1	DTS-HD	DVD Forum DTS- HD [28]	IEC 61937-5 [17]								
1	1	0	0	MLP	DVD Forum MLP [27]	IEC 61937-9 [21]								
1	1	0	1	DST	ISO/IEC 14496-3 [24] subpart 10									
1	1	1	0	WMA Pro	WMA Pro Decoder Specification [30]	IEC 61937-8 [20]								
1	1	1	1	Refer to Audio Coding Extension Type (CXT) field in Data Byte 3										

Table 24 Audio InfoFrame Data Byte 1

Data Byte 2, bits SF2, SF1, and SF0, when coded, indicate the audio sampling frequency in the audio stream. These bits shall be set according to Table 25. A sink capable of receiving digital audio shall determine the audio sampling frequency by parsing the audio stream header when SF=0 (SF2=0, SF1=0, SF0=0).

Data Byte 2, bits SS1 and SS0, when coded, indicate the number of bits per audio sample in the audio stream. These bits shall be set according to Table 25. A sink capable of receiving digital audio shall determine the number of bits per audio sample by parsing the audio stream header when SS=0 (SS1=0, SS0=0)

SF2	SF1	SF0	Sampling Frequency	SS1	SS0	Sample Size
0	0	0	Refer to Stream Header	0	0	Refer to Stream header
0	0	1	32 kHz	0	1	16 bit
0	1	0	44.1 kHz (CD)	1	0	20 bit
0	1	1	48 kHz	1	1	24 bit
1	0	0	88.2 kHz			
1	0	1	96 kHz			
1	1	0	176.4 kHz			
1	1	1	192 kHz			

Table 25 Audio InfoFrame Data Byte 2

Data Byte 3, bits CXT4, CXT3, CXT2, CXT1, and CXT0, when coded and when the CT field in Data Byte 1 is set to 15, indicate the audio format type of the audio stream. The CXT4-CXT0 bits shall be set to 0x00 (CXT4=0, CXT3=0, CXT2=0, CXT1=0, CXT0=0) when the CT field in Data Byte 1 is set to a value other than 15. When the CT field in Data Byte 1 is set to 15 (CT3=1, CT2=1, CT1=1, CT0=1) the CXT bits may be set according to Table 26. When CXT=0 (CXT4=0, CXT3=0, CXT2=0, CXT1=0, CXT0=0) a sink capable of receiving digital audio shall determine the audio format by analyzing the value of the CT field in Data Byte 1 or by parsing the audio stream header.

C X T 4	C X T 3	C X T 2	C X T 1	C X T 0	Audio Coding Extension Type	Audio Stream Encoding Standard	Audio Stream Transport Standard
0	0	0	0	0	Refer to Audio Coding Type (CT) field in Data Byte 1		
0	0	0	0	1	HE-AAC	ISO/IEC 14496-3:2005 [24]	IEC 61937-6 [18]
0	0	0	1	0	HE-AACv2	ISO/IEC 14496-3:2005/AMD2:2006 [25]	IEC 61937-6 [18]
0	0	0	1	1	MPEG Surround	ISO/IEC 23003-1:2007 [26]	
0x04 – 0x1F					Reserved		

Table 26 Audio Format Code Extension (Data Byte 3)

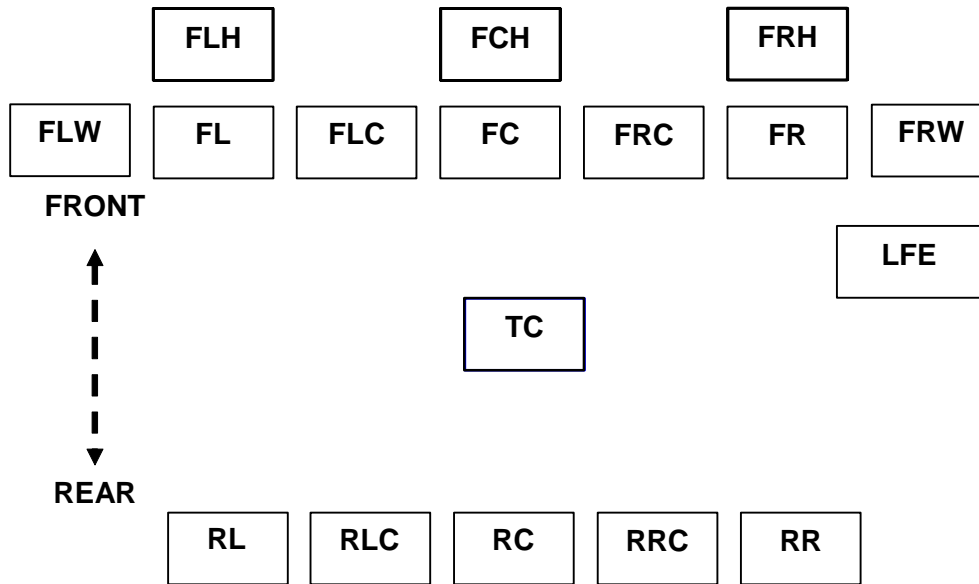
### 6.6.2 Speaker Mapping and Down-mix Information

Data Bytes 4 and 5 apply only to multi-channel (i.e., more than two channels) uncompressed audio.

CEA-861-E contains the capability to transmit Multi-Channel Linear Pulse Code Modulation (LPCM) Audio by using up to four IEC 60958-3 [13] compliant transport streams. This is because the Audio InfoFrame and the CEA Extension are capable of supporting up to eight channels of LPCM. However, additional information is required to support carriage of Multi-Channel LPCM streams. This information is provided by the speaker channel allocation information in Data Byte 4.

Data Byte 4 contains information that describes how various speaker locations are allocated to transmission channels. Data Byte 5 contains information that tells the sink how much the source attenuated the audio during a down-mixing operation. The down-mix inhibit flag (**DM\_INH**) describes whether audio output is permitted to be down-mixed or not. This flag is used in DVD Audio applications.

The labels and placements of speakers used in CEA-861-E are defined in Figure 6 and Table 27 (see Annex K for additional information concerning speaker placement relationships between CEA-861-E and other standards).



**Figure 6 Speaker Placement**

Label	Location
FL	Front Left
FC	Front Center
FR	Front Right
FLC	Front Left Center
FRC	Front Right Center
RL	Rear Left
RC	Rear Center
RR	Rear Right
RLC	Rear Left Center
RRC	Rear Right Center
LFE	Low Frequency Effect
FLW	Front Left Wide
FRW	Front Right Wide
FLH	Front Left High
FCH	Front Center High
FRH	Front Right High
TC	Top Center

**Table 27 Speaker Placement**

NOTE—FLW/FRW are front perimeter speakers, outside of the front main speakers. FLH/FCH/FRH are front elevated speakers, generally above the front main speakers. The TC is an upper surround or overhead speaker, directly above overhead.

Data Byte 4 contains information that describes how various speaker locations are allocated to transmission channels. Channel allocation is shown in Table 28 (see Annex K for additional information concerning audio channel allocation relationships between CEA-861-E and other standards).

CA (binary)								CA (hex)	Channel Number							
7	6	5	4	3	2	1	0		8	7	6	5	4	3	2	1
0	0	0	0	0	0	0	0	0x00	-	-	-	-	-	-	FR	FL
0	0	0	0	0	0	0	1	0x01	-	-	-	-	-	LFE	FR	FL
0	0	0	0	0	0	1	0	0x02	-	-	-	-	FC	-	FR	FL
0	0	0	0	0	0	1	1	0x03	-	-	-	-	FC	LFE	FR	FL
0	0	0	0	0	1	0	0	0x04	-	-	-	RC	-	-	FR	FL
0	0	0	0	0	1	0	1	0x05	-	-	-	RC	-	LFE	FR	FL
0	0	0	0	0	1	1	0	0x06	-	-	-	RC	FC	-	FR	FL
0	0	0	0	0	1	1	1	0x07	-	-	-	RC	FC	LFE	FR	FL
0	0	0	0	1	0	0	0	0x08	-	-	RR	RL	-	-	FR	FL
0	0	0	0	1	0	0	1	0x09	-	-	RR	RL	-	LFE	FR	FL
0	0	0	0	1	0	1	0	0x0A	-	-	RR	RL	FC	-	FR	FL
0	0	0	0	1	0	1	1	0x0B	-	-	RR	RL	FC	LFE	FR	FL
0	0	0	0	1	1	0	0	0x0C	-	RC	RR	RL	-	-	FR	FL
0	0	0	0	1	1	0	1	0x0D	-	RC	RR	RL	-	LFE	FR	FL
0	0	0	0	1	1	1	0	0x0E	-	RC	RR	RL	FC	-	FR	FL
0	0	0	0	1	1	1	1	0x0F	-	RC	RR	RL	FC	LFE	FR	FL
0	0	0	1	0	0	0	0	0x10	RRC	RLC	RR	RL	-	-	FR	FL
0	0	0	1	0	0	0	1	0x11	RRC	RLC	RR	RL	-	LFE	FR	FL
0	0	0	1	0	0	1	0	0x12	RRC	RLC	RR	RL	FC	-	FR	FL
0	0	0	1	0	0	1	1	0x13	RRC	RLC	RR	RL	FC	LFE	FR	FL
0	0	0	1	0	1	0	0	0x14	FRC	FLC	-	-	-	-	FR	FL
0	0	0	1	0	1	0	1	0x15	FRC	FLC	-	-	-	LFE	FR	FL
0	0	0	1	0	1	1	0	0x16	FRC	FLC	-	-	FC	-	FR	FL
0	0	0	1	0	1	1	1	0x17	FRC	FLC	-	-	FC	LFE	FR	FL
0	0	0	1	1	0	0	0	0x18	FRC	FLC	-	RC	-	-	FR	FL
0	0	0	1	1	0	0	1	0x19	FRC	FLC	-	RC	-	LFE	FR	FL
0	0	0	1	1	0	1	0	0x1A	FRC	FLC	-	RC	FC	-	FR	FL
0	0	0	1	1	0	1	1	0x1B	FRC	FLC	-	RC	FC	LFE	FR	FL
0	0	0	1	1	1	0	0	0x1C	FRC	FLC	RR	RL	-	-	FR	FL
0	0	0	1	1	1	0	1	0x1D	FRC	FLC	RR	RL	-	LFE	FR	FL
0	0	0	1	1	1	1	0	0x1E	FRC	FLC	RR	RL	FC	-	FR	FL
0	0	0	1	1	1	1	1	0x1F	FRC	FLC	RR	RL	FC	LFE	FR	FL
0	0	1	0	0	0	0	0	0x20	-	FCH	RR	RL	FC	-	FR	FL
0	0	1	0	0	0	0	1	0x21	-	FCH	RR	RL	FC	LFE	FR	FL
0	0	1	0	0	0	1	0	0x22	TC	-	RR	RL	FC	-	FR	FL
0	0	1	0	0	0	1	1	0x23	TC	-	RR	RL	FC	LFE	FR	FL
0	0	1	0	0	1	0	0	0x24	FRH	FLH	RR	RL	-	-	FR	FL
0	0	1	0	0	1	0	1	0x25	FRH	FLH	RR	RL	-	LFE	FR	FL
0	0	1	0	0	1	1	0	0x26	FRW	FLW	RR	RL	-	-	FR	FL
0	0	1	0	0	1	1	1	0x27	FRW	FLW	RR	RL	-	LFE	FR	FL
0	0	1	0	1	0	0	0	0x28	TC	RC	RR	RL	FC	-	FR	FL
0	0	1	0	1	0	0	1	0x29	TC	RC	RR	RL	FC	LFE	FR	FL
0	0	1	0	1	0	1	0	0x2A	FCH	RC	RR	RL	FC	-	FR	FL
0	0	1	0	1	0	1	1	0x2B	FCH	RC	RR	RL	FC	LFE	FR	FL
0	0	1	0	1	1	0	0	0x2C	TC	FCH	RR	RL	FC	-	FR	FL
0	0	1	0	1	1	0	1	0x2D	TC	FCH	RR	RL	FC	LFE	FR	FL



0	0	1	0	1	1	1	0	0x2E	FRH	FLH	RR	RL	FC	-	FR	FL
0	0	1	0	1	1	1	1	0x2F	FRH	FLH	RR	RL	FC	LFE	FR	FL
0	0	1	1	0	0	0	0	0x30	FRW	FLW	RR	RL	FC	-	FR	FL
0	0	1	1	0	0	0	1	0x31	FRW	FLW	RR	RL	FC	LFE	FR	FL
0	0	1	1	0	0	1	0	0x32	Reserved							
...																
1	1	1	1	1	1	1	1	0xFF								

**Table 28 Audio InfoFrame Data Byte 4**

The sink's speaker allocation is not always the same as that contained within the source audio. In this case, the source should down mix the audio in order to properly meet the sink's speaker configuration. In actual implementations, all down-mix coefficients are equally attenuated to prevent calculation overflows. The total sound level becomes lower after down-mixing. For this reason, the Level Shift Value should also be transmitted to the sink to insure the proper sound level is achieved.

Data Byte 5 contains Level Shift Information, a Down-mix Inhibit Flag, and LFE playback level information.

The values of attenuation associated with the Level Shift Values (LSV0-LSV3) are shown in Table 29.

LSV3	LSV2	LSV1	LSV0	Level Shift Value
0	0	0	0	0dB
0	0	0	1	1dB
0	0	1	0	2dB
0	0	1	1	3dB
0	1	0	0	4dB
0	1	0	1	5dB
0	1	1	0	6dB
0	1	1	1	7dB
1	0	0	0	8dB
1	0	0	1	9dB
1	0	1	0	10dB
1	0	1	1	11dB
1	1	0	0	12dB
1	1	0	1	13dB
1	1	1	0	14dB
1	1	1	1	15dB

**Table 29 Audio InfoFrame Data Byte 5, Level Shift Value**

The Down-mix Inhibit Flag is shown in Table 30.

DM_INH	Describes whether the down mixed stereo output is permitted or not.
0	Permitted or no information about any assertion of this
1	Prohibited

**Table 30 Audio InfoFrame Data Byte 5, Down-mix Inhibit Flag**

The LFE playback level information is shown in Table 31.

LFEPL1	LFEPL0	Describes what value is used for LFE playback level comparing with other channel signal.
0	0	Unknown or refer to other information
0	1	0 dB playback
1	0	+ 10 dB playback
1	1	Reserved

**Table 31 Audio InfoFrame Data Byte 5, LFE Playback Level Information**

### 6.7 MPEG Source InfoFrame

The MPEG Source InfoFrame describes aspects of the compressed video stream that were used to produce the uncompressed video. In many cases, the compressed source is MPEG2, although this InfoFrame can be applied to any similar compressed format. Some sinks may use this information to improve the displayed picture.

NOTE— Implementation of the MPEG Source Infoframe is not recommended due to issues that have been reported and not resolved. The information contained in this section is reserved for future use and enhancement.

Transmission of this information by the source is optional. Use of this information by the sink is also optional.

If the source supports the transmission of the MPEG Source InfoFrame and if it determines that the sink is capable of receiving the MS InfoFrame (i.e., the sink has included CEA Extension Version 3 in EDID), then this information should be sent once per video frame when applicable. The data applies to the next full frame of video data.

The format of the MPEG Source InfoFrame is shown in Table 32.

InfoFrame Type Code	InfoFrame Type = 0x05							
InfoFrame Version Number	Version = 0x01							
Length of MPEG Source InfoFrame	Length of MPEG Source InfoFrame (10)							
Data Byte 1	MB#0 (MPEG Bit Rate: Hz Lower → Upper)							
Data Byte 2	MB#1							
Data Byte 3	MB#2							
Data Byte 4	MB#3 ( Upper Byte )							
Data Byte 5	F57=0	F56=0	F55=0	FR0	F53=0	F52=0	MF1	MF0
Data Byte 6	F67=0	F66=0	F65=0	F64=0	F63=0	F62=0	F61=0	F60=0
Data Byte 7	F77=0	F76=0	F75=0	F74=0	F73=0	F72=0	F71=0	F70=0
Data Byte 8	F87=0	F86=0	F85=0	F84=0	F83=0	F82=0	F81=0	F80=0
Data Byte 9	F97=0	F96=0	F95=0	F94=0	F93=0	F92=0	F91=0	F90=0
Data Byte 10	F107=0	F106=0	F105=0	F104=0	F103=0	F102=0	F101=0	F100=0

**Table 32 MPEG Source InfoFrame format**

Data Bytes 1-4 give the MPEG bit rate. The MPEG Bit Rate is stored as a 32-bit number and is expressed in Hertz. MB#0 contains the least significant byte while MB#3 contains the most significant byte. If the MPEG Bit Rate is unknown or this field does not apply, then all of the bits in Data Bytes 1-4 shall be set to 0.

#### Example:

10 Mbps → 10,000,000 Hz (dec.) → 0x00989680 Upper ... Lower Byte

**Byte 1 MB#0** 0x80 Lower Byte

**Byte 2 MB#1** 0x96

**Byte 3 MB#2** 0x98

**Byte 4 MB#3** 0x00 Upper

MF1 and MF0 in Data Byte 5 (see Table 33) designate whether the current field/frame was generated from an I, B, or P picture from the source MPEG stream. If this is unknown or does not apply, then the field shall be set to “unknown.”

In some cases, the source creates 60 field/second video from 24 frames/second source material. 3:2 pulldown is commonly used. FR0 can be used to designate whether a field is a repeated field or not. The sink can use this information to improve the picture. If 3:2 pulldown does not apply to the current video decoding, then all of the fields/frames should be marked as “New field.”

FR0	Field Repeat (for 3:2 pull-down)	MF1	MF0	MPEG Frame
0	New field (picture)	0	0	Unknown (No Data)
1	Repeated Field	0	1	I Picture
		1	0	B Picture
		1	1	P Picture

**Table 33 MPEG Source InfoFrame Data Byte 5**

### 6.8 NTSC VBI InfoFrame

The NTSC VBI InfoFrame provides for the carriage of SCTE 127 [29] payloads containing VBI data. Transmission of this information by the source is optional. Use of this information by the sink is also optional. However, when present, sinks can extract this information for direct use, or when analog NTSC outputs are present, regenerate relevant VBI data along with the video and audio.

This InfoFrame should be sent once per video frame when applicable. The data applies to the next full frame of video data.

The format of the NTSC VBI InfoFrame is shown in Table 34.

InfoFrame Type Code	InfoFrame Type = 0x06
InfoFrame Version Number	Version = 0x01
Length of NTSC VBI	Length of NTSC VBI InfoFrame – total number of bytes following this field
Data Bytes 1...Length	The PES_data_field() structure of SCTE 127, Table 2 [29]

**Table 34 NTSC VBI InfoFrame**

The stuffing\_bytes should be omitted before source transmission.

In order to maximize the possibility of operation with existing silicon, sources should constrain the InfoFrame to 31 bytes or less. This means the PES\_data\_field() structure would be constrained (modified if necessary) to 27 bytes. NABTS (which requires 37 bytes) should not be encoded.

Note: 31 bytes is adequate, for example, for two fields of AMOL96 and one field of TVG2X per frame.

### 7 EDID Data Structure

Extended Display Identification Data (EDID) was created by VESA to enable plug and play capabilities of displays (sinks). This data, which is stored in the sink, describes video formats that the DTV (display) is

capable of receiving and rendering. The information is supplied to the source, over the interface, upon the request of the source. The source then chooses its output format, taking into account the format of the original video stream and the formats supported by the sink. Format conversions necessary to supply video to the sink should be determined according to recommendations in Annex F.

The EDID data structures version 1, revision 3 [10] and newer are known as Enhanced EDID (E-EDID). Sources should interpret and sinks should implement the EDID data structure according to the VESA E-EDID Implementation Guide [59]. Sink implementers should verify a sink's EDID data structure using the VESA E-EDID Verification Guide [63]. The sink shall support E-DDC [9] as the method of transporting EDID information. A source shall be capable of using E-DDC [9] to read the entire EDID since critical information may not otherwise be readable if the sink contains a large EDID.

Some sinks may contain more than 2 blocks of EDID data. For example, the sink may include a second CEA-861 Extension Block, a VESA DI-EXT Block (as defined in VESA DI-EXT [58]) or a VTB-EXT Block (as defined in VESA VTB-EXT [66]). In this case the sink is required to support E-DDC Addressing (using the Segment Pointer) as defined in VESA E-DDC [9]. It is also recommended that the source be capable of reading and parsing more than 2 blocks of EDID data. For more information on E-DDC addressing refer to the VESA E-DDC Standard [9].

The base EDID (Block 0) contains both version and revision numbers. The version number indicates the data structure of the base EDID, which remains backwards compatible as the revision number changes. Therefore, a source should continue parsing a recognized structure version - even if it encounters an unexpected revision number.

The sink shall protect its EDID from accidental corruption resulting from I2C errors by write-protecting its contents.

See Annex A and Annex D for an example EDID.

### 7.1 Use of CEA Extensions

Two of the four 18-byte descriptor slots contained in EDID Block 0 are designated for a Monitor Range Limits Descriptor and a Monitor Name Descriptor. Users of CEA-861-E should note that future alternate usage of these descriptors is possible, including replacing them with additional Detailed Timing Descriptors, and, therefore, dependency upon data in these descriptors should be avoided. Consequently, the E-EDID standard provides a method for including only two Detailed Timing Descriptors. To accommodate additional Detailed Timing Descriptors, the CEA Extension has been defined. The tag (0x02) for this extension was previously reserved within VESA, but has now been assigned to CEA for the purposes of CEA-861-E. Therefore, further changes to this structure are under the control of CEA. It is referred to in CEA-861-E as the CEA Extension.

Three versions of the CEA Extension exist. If more than one CEA Extension is included in EDID, they shall all be the same version.

To maintain backward compatibility, newer versions of the CEA Extension include all of the fields that were present in the previous versions. Additionally, length fields are provided on internal data structures to convey block size and to aid the source in interpreting the data. This may help a source to determine whether or not the field is valid. Future versions of the CEA Extension are expected to have the version number incremented and be backward compatible with previous versions. A current generation source is capable of parsing these future EDIDs exactly as it does existing EDIDs, if it ignores the version number. Sources should continue parsing the EDID structure even if an unexpected version number is encountered.

CEA Extension Version 1 only provides a way to supply extra Detailed Timing Descriptors. It is still permitted to be used for some sinks (e.g. limited format DVI displays) but Version 3 is more applicable for most devices.

CEA Extension Version 2 is no longer supported and shall not be included in sinks.

CEA Extension Version 3 includes all of the fields and capabilities of Versions 1 & 2, but also includes the ability to specify any of the CEA video formats using "CEA Short Video Descriptors." It provides the ability for the sink to specify what types of advanced audio it supports using "CEA Short Audio Descriptors." It also provides a way for the sink to specify its speaker configuration. This information is complementary to the speaker channel allocation information that is sent in the Audio InfoFrame.

If a sink supports any video format with a format code greater than 7,  $Y_C_B C_R$  color space, InfoFrames, or digital audio (e.g., is an HDMI monitor), then it shall include the version 3 (or higher) CEA Extension in its EDID data structure.

## 7.2 Describing Video Formats in EDID

Two methods of describing video formats are used in CEA-861-E: Detailed Timing Descriptors and CEA Short Video Descriptors.

The sink shall declare support for all of the DTV formats that it supports in EDID block 0 or in the CEA Extension(s). The 640x480@60Hz flag, in the Established Timings area, shall always be set, since the 640x480p format is a mandatory default timing.

When using CEA Extension Version 1, all of the CEA video formats listed in E-EDID are described using Detailed Timing Descriptors. No matter which CEA Extension is used, there is also room for two Detailed Timing Descriptors in EDID Block 0. CEA Extension Version 3 can include a combination of Detailed Timing Descriptors and Short Video Descriptors.

If a Version 3 CEA Extension has been included in EDID, all CEA video formats shall be advertised using Short Video Descriptors, even if they are also advertised using the Detailed Timing Descriptors (see 7.2.1).

Even though Short Video Descriptors are available in the Version 3 CEA Extension, there is still a need to use Detailed Timing Descriptors if full backward compatibility with legacy sources is desired. Formats with video ID codes of 2 to 5 and 17 to 20 should be advertised using the Detailed Timing Descriptors for any video formats that the DTV designer wishes to guarantee are available to sources that cannot interpret the Short Video Descriptors and that require Detailed Timing Descriptors for proper operation. If sufficient room is not available in the first two blocks of the EDID for all of the supported video formats, the DTV designer may choose to declare support for some of the less important formats in Short Video Descriptors only.

### 7.2.1 Use of EDID Detailed Timing Descriptors

As required in Section 4, a DTV that declares it is capable of displaying a video timing with a vertical frequency that is either an integer multiple of 6 Hz or an integer multiple of 6 Hz adjusted by a factor of 1000/1001 shall be capable of displaying both versions of the video timing. DTVs capable of displaying 59.94/60 Hz versions of video timings shall declare in the EDID structure the 60Hz version of the video timing for all video formats, except the 240-line and 480-line formats, which shall declare 59.94Hz version of the video timing.

All DTDs and SVDs shall be listed in order of priority; meaning that the first is the one that the display manufacturer has identified as optimal.

Note that the EDID Detailed Timing Descriptor allows for the designation of an interlaced format. However, there are no provisions to specify separate vertical blanking/sync for Field 1 and Field 2. Therefore, for the purposes of CEA-861-E, the following rules apply for interlaced formats:

- a) The Field 1 Vertical Blanking Interval shall equal the Vertical Blanking Lines in the Detailed Timing Descriptor.
- b) The Field 2 Vertical Blanking Interval shall equal the Vertical Blanking Lines in the Detailed Timing Descriptor + 1.

- c) The Field 1 Vertical Sync Offset shall equal the Vertical Sync Offset in the Detailed Timing Descriptor.  
 d) The Field 2 Vertical Sync Offset shall equal the Vertical Sync Offset in the Detailed Timing Descriptor + 1/2.

A sink capable of receiving a video format with a video identification code greater than 7 or capable of receiving a dual-aspect ratio timing shall declare different Detailed Timing Descriptors in its EDID for each supported video timing with a different picture aspect ratios. The vertical and horizontal image size parameters in the EDID shall contain numbers that describe the aspect ratio of the displayed video (actual dimensions are preferred, but not required).

A special interlaced video timing exists (see Figure 5) that modifies the Field 2 Vertical Blanking Interval (b) and Vertical Sync Offset (d) values presented here. When all DTD parameters match those of video identification code 39 (see Table 35) and a SVD indicating support for code 39 video format also exists, the Field 2 Vertical Blanking Interval (b) and Vertical Sync Offset (d) shall instead equal the DTD's "Vertical Blanking Lines" and the DTD's "Vertical Sync Offset" - 1/2, respectively.

Byte #	Data Hex	Dec	Description	Remarks
1	0x20	32	Pixel Clock	72.00 MHz
2	0x1C	28		
3	0x80	128	H Active	1920 pixels
4	0x80	128	H Blanking	384 pixels
5	0x71	113	H Active: H Blanking	
6	0x1C	28	V Active	540 lines
7	0x55	85	V Blanking	85 lines
8	0x20	32	V Active: V Blanking	
9	0x20	32	H Sync Offset	32 pixels
10	0xA8	168	H Sync Pulse Width	168 pixels
11	0x75	117	VS Offset: VS Pulse Width	23 lines, 5 lines
12	0x04	4	HS Offset: HS Pulse Width: VS Offset: VS Pulse Width	
13	(any)	(any)	H Image Size	(any)
14	(any)	(any)	V Image Size	(any)
15	(any)	(any)	H&V Image Size	
16	0x00	0	H Border	0 lines
17	0x00	0	V Border	0 pixels
18	0x9A, 0x9B, 0xBA, 0xBB, 0xDA, 0xDB, 0xFA, or 0xFB	154, 155, 186, 187, 218, 219, 250, or 251	Flags	Interlaced, digital separate, Vsync polarity is negative, Hsync polarity is positive (NOTE: stereo mode bits 0, 5, & 6 may have any value)

**Table 35 Video Timing Code 39 Detailed Timing Descriptor**

Examples of Detailed Timing Descriptors for the video formats are contained in Annex A.

### 7.2.2 Order of Dual-Aspect Ratio Detailed Timing Descriptors

A sink that supports any dual aspect ratio timing shall, in its EDID, list the DTD and SVD with the preferred picture aspect ratio before the DTD and SVD with the other picture aspect ratio. Per section 4.1,

a sink is required to assume that any video field matching a video timing is to be displayed at the preferred picture aspect ratio unless it receives an alternate indication in an AVI InfoFrame.

A sink not capable of receiving AVI InfoFrames shall only declare video formats with different video timings in its EDID data structure unless the sink declares it is capable of displaying a video timing in either picture aspect ratio.

### 7.2.3 Source Requirements and Recommendations

It is strongly recommended that a source provide an option of operating in "pass-through" mode. When operating in "pass-through" mode, the source transmits the video to the sink without performing any interlacing, deinterlacing, or scaling on the transmitted content. A source operating in "pass through" mode determines the supported video formats of the sink and utilizes this information to ensure that it passes through only video formats supported by the sink. If no corresponding video format is supported by the sink, then some conversion is necessary; it is recommended that the conversion be to the first format in the EDID that the source supports. Detailed recommendations for sources and sinks, plus examples of different conversions are illustrated in Annex F. Typically, PCs and game machines locally determine the resolution of the content rather than processing pre-recorded or broadcast content at a preset resolution. In these cases, it is recommended that the source generate the content in the first format in the EDID that the source supports. The source shall read the EDID to determine if a specific format is supported. The source shall only choose an output format listed in the EDID except in the following circumstances:

1. The source can not find a format in the EDID which it supports.
2. The user manually overrides the automatic behavior.

### 7.3 CEA Extension Version 1

The first version was created for CEA-861 and only provides a way to supply extra EDID Detailed Timing Descriptors.

The CEA Extension in Table 36 follows the format described in Section 2.2.1.3 of VESA E-EDID Standard [10]. The EDID Extension Tag for this extension shall be 0x02. The first detailed timing (DTD) listed in the base EDID data structure is preferred. The first short video descriptor (SVD), listed in the CEA extension, is also preferred.

Byte #	Value	Description	Format
0	0x02	Tag (0x02)	
1	0x01	Revision Number	
2		Byte number offset $d$ where 18-byte descriptors begin (typically Detailed Timing Descriptors)	$d$ = offset for the byte following the reserved data block. If no data is provided in the reserved data block, then $d=4$ . If no DTDs are provided, then $d=0$ .
3		Reserved	Set to 0x00
4		Start reserved data block	This section was previously reserved for 8 byte timing descriptors but is currently a reserved data block.
$d-1$		End of reserved data block.	
$d$		Start of 18-byte descriptors	See Section 3.10.2 of VESA E-EDID Standard [10]
$d+(18*n)-1$		End of 18-byte descriptors where $n$ is the number of descriptors included	
$d+(18*n)$	0x00	Beginning of Padding	
126	0x00	End of Padding	
127		Checksum	0xXX = This byte should be programmed such that a one-byte checksum (add all bytes together) of the entire 128 byte block equals 0x00.

Table 36 CEA Extension Version 1

#### 7.4 CEA Extension Version 2

CEA Extension Version 2 is deprecated and shall not be included in sinks. See Table 37.



Byte #	Value	Description	Format
0	0x02	Tag (0x02)	
1	0x02	Revision Number	
2		Byte number offset $d$ where 18-byte descriptors begin (typically Detailed Timing Descriptors)	$d$ = offset for the byte following the reserved data block. If no data is provided in the reserved data block, then $d=4$ . If $d=0$ , then no detailed timing descriptors are provided and no data is provided in the reserved data block.
3		Total number of native Detailed Timing Descriptors in entire E-EDID structure. Also, indication of underscan support, audio support, and support of YC <sub>B</sub> C <sub>R</sub> is included	<b>bit 7</b> (underscan) = 1 if sink underscans IT video formats by default. <b>bit 6</b> (audio) = 1 if sink supports basic audio. <b>bit 5</b> (YC <sub>B</sub> C <sub>R</sub> 4:4:4) = 1 if sink supports YC <sub>B</sub> C <sub>R</sub> 4:4:4 in addition to RGB. <b>bit 4</b> (YC <sub>B</sub> C <sub>R</sub> 4:2:2) = 1 if sink supports YC <sub>B</sub> C <sub>R</sub> 4:2:2 in addition to RGB. <b>lower 4 bits</b> = total number of native DTDs (see Section 2.2 for definition of "Native Format").
4		Start reserved data block	This section was previously reserved for 8 byte timing descriptors <sup>8</sup> but is currently a reserved data block.
$d-1$		End of reserved data block.	
$d$		Start of 18-byte descriptors	See Section 3.10.2 of VESA E-EDID Standard[10]
$d+(18*n)-1$		End of 18-byte descriptors where $n$ is the number of descriptors included	
$d+(18*n)$	0x00	Beginning of Padding	
126	0x00	End of Padding	
127		Checksum	
			0xXX = This byte should be programmed such that a one-byte checksum (add all bytes together) of the entire 128 byte block equals 0x00.

Table 37 CEA Extension Version 2

### 7.5 CEA Extension Version 3

Version 3 includes all of the capabilities of Versions 1 & 2, but also includes the ability to specify any of the CE video formats using "CEA Short Video Descriptors." It provides the ability for the sink to specify what types of advanced audio it supports using "CEA Short Audio Descriptors." It also provides a way for the sink to specify its speaker configuration. This information is complementary to the speaker channel allocation information that is sent in the Audio InfoFrame.

If more than one CEA extension is needed, the value of byte 3 shall be the same in all extensions.

CEA Extension Version 3 is shown in Table 38.

<sup>8</sup> The 8-byte descriptors do not support the CE video formats defined in this standard since they are not compliant with VESA GTF [60].

Byte #	Value	Description	Format
0	0x02	Tag (0x02)	
1	0x03	Revision Number	
2		Byte number offset <b>d</b> where 18-byte descriptors begin (typically Detailed Timing Descriptors)	<b>d</b> = offset for the byte following the reserved data block. If no data is provided in the reserved data block, then <b>d=4</b> . If <b>d=0</b> , then no detailed timing descriptors are provided and no data is provided in the reserved data block.
3		Total number of Detailed Timing Descriptors describing native formats in entire E-EDID structure. Also, indication of underscan support, audio support, and support of YC <sub>B</sub> C <sub>R</sub> is included	<b>bit 7</b> (underscan) = 1 if sink underscans IT video formats by default. <b>bit 6</b> (audio) = 1 if sink supports basic audio. <b>bit 5</b> (YC <sub>B</sub> C <sub>R</sub> 4:4:4) = 1 if sink supports YC <sub>B</sub> C <sub>R</sub> 4:4:4 in addition to RGB. <b>bit 4</b> (YC <sub>B</sub> C <sub>R</sub> 4:2:2) = 1 if sink supports YC <sub>B</sub> C <sub>R</sub> 4:2:2 in addition to RGB. <b>lower 4 bits</b> = total number of native DTDs (see Section 2.2 for definition of "Native Format").
4		Start of data block collection	This section is used for CEA Data Block Collection (see Table 39).
<b>d-1</b>		End of data block collection.	
<b>d</b>		Start of 18-byte detailed timing descriptors	See Section 3.10.2 of VESA E-EDID Standard [10]
<b>d+(18*n)-1</b>		End of 18-byte detailed timing descriptors where <b>n</b> is the number of descriptors included	
<b>d+(18*n)</b>	0x00	Beginning of Padding	
126	0x00	End of Padding	
127		Checksum	This byte should be programmed such that a one-byte checksum (add all bytes together) of the entire 128 byte block equals 0x00.

Table 38 CEA Extension Version 3

The lower 4 bits of byte 3 indicates the total number of DTDs defining native formats in the whole EDID (see Section 2.2 for definition of "Native Format"). The placement of native DTDs shall be contiguous, starting with the first DTD in the DTD list (which starts in the base EDID block). Value zero means that this information is not provided (for backward compatibility with prior implementations), or that the display does not support reception of native format.

In most cases, the native format count equals one, but a CRT-based display may indicate support for two: a native progressive and a native interlaced timing.

A DTV that declares it is capable of displaying pictures formatted in either YC<sub>B</sub>C<sub>R</sub> chroma sampling format (i.e., 4:2:2 or 4:4:4) shall be capable of displaying pictures encoded in either SMPTE 170M [1] color space or ITU-R BT.709 [7] color space. DTVs capable of displaying pictures encoded in other color spaces may declare support for these color spaces in a Colorimetry Block stored in their EDID. The format of the Colorimetry Data Block is defined in Section 7.5.5.

In order to ensure YC<sub>B</sub>C<sub>R</sub> interoperability between any two YC<sub>B</sub>C<sub>R</sub>-capable devices, a sink that supports either type of YC<sub>B</sub>C<sub>R</sub> pixel data (4:2:2 or 4:4:4) should support both types and therefore would set both bits 4 and 5 of byte 3.

NOTE—The HDMI specification requires this behavior.

A sink that does not support YC<sub>B</sub>C<sub>R</sub> pixel data shall have both bits 4 and 5 clear.

If the sink supports any type of digital audio on this interface, then it shall also support Basic Audio and shall indicate this by setting the Basic Audio bit (bit 6).

Bit 7 of byte 3 shall be set if the sink underscans IT video formats by default.

The format of the “CEA Data Block Collection” shall conform to that shown in Table 39. The order of the Data Blocks is not constrained. It is also possible to have more than one of a specific type of data block if necessary to include all of the descriptors needed to describe the sink’s capabilities.

The header of a Data Block consists of one byte (Table 40), with 3 bits used for the tag code to label the type of data and 5 bits used to indicate the length of the block. The list of tag codes is shown in Table 41. The length does not include the tag. The General Tag format is shown in Table 40. The first three bits are a Tag Code. This Tag Code designates the format of the bytes that follow. The last five bits are a length field that designates the number of bytes in the data block associated with the tag. The number of bytes does not include the tag. In the case of a video data block or an audio data block, the data block consists of a number of Short Video Descriptors. For other data blocks, the format may be different (e.g., Speaker Allocation Data Block). However, the length is always the number of bytes following the tag.

	Byte#	Bits 5-7	Bits 0-4
Video Data Block	1	Video Tag Code	length=total number of video bytes following this byte ( $L_1$ )
	2	CEA Short Video Descriptor 1	
	3	CEA Short Video Descriptor 2	
	...	...	
	$1+L_1$	CEA Short Video Descriptor $L_1$	
Audio Data Block	$2+L_1$	Audio Tag Code	length=total number of audio bytes following this byte ( $L_2$ )
	$3+L_1$	CEA Short Audio Descriptor 1	
	$4+L_1$		
	$5+L_1$		
	...	...	
	$L_1+L_2$	CEA Short Audio Descriptor $L_2/3$	
	$1+L_1+L_2$		
$2+L_1+L_2$			
Speaker Allocation Data Block	$3+L_1+L_2$	Speaker Allocation Tag Code	length=total number of speaker allocation bytes following this byte ( $L_3=3$ )
	$4+L_1+L_2$	Speaker Allocation Data Block Payload (3 bytes)	
	$5+L_1+L_2$		
	$6+L_1+L_2$		
Vendor Specific Data Block	$7+L_1+L_2$	Vendor Specific Tag Code	length=total number of vendor specific bytes following this byte ( $L_4$ )
	$8+L_1+L_2$	24-bit IEEE Registration Identifier (least significant byte first)	
	$9+L_1+L_2$		
	$10+L_1+L_2$		
	....	Vendor Specific Data Block Payload ( $L_4-3$ bytes)	
.....			
Video Capability Data Block	$8+L_1+L_2+L_4$	Extended Tag Code	length=total number of bytes in this block following this byte ( $L_5$ )
	$9+L_1+L_2+L_4$	Video Capabilities Ext. Tag Code = 00h	
	$10+L_1+L_2+L_4$	Video Capabilities Data Byte 3 (see section 7.5.6)	

Table 39 General Format of “CEA Data Block Collection”

These data structures may grow in the future and so the source shall continue to parse the known (currently specified) fields in a data block even if the length is longer than currently specified.

Byte#	bits							
	7	6	5	4	3	2	1	0
1	Tag Code			Length of following data block payload (in bytes)				

**Table 40 Data Block Header Byte**

Codes	Type of Data Block
0	Reserved
1	Audio Data Block (includes one or more Short Audio Descriptors)
2	Video Data Block (includes one or more Short Video Descriptors)
3	Vendor Specific Data Block
4	Speaker Allocation Data Block
5	VESA DTC Data Block
6	Reserved
7	Use Extended Tag

**Table 41 CEA Data Block Tag Codes**

If the Tag Code is 7 (Use Extended Tag) then the second byte of the data block contains the Extended Tag Code, which indicates the actual type of the data block. For backwards compatibility, the Length field in the first byte does include the second byte, which contains the Extended Tag Code. Note that data blocks with Tag Codes of 1 through 6 are limited to containing 31 useful bytes whereas those with Extended Tag Codes are limited to 30 useful bytes.

Byte#	bits							
	7	6	5	4	3	2	1	0
2	Extended Tag Code							

**Table 42 Extended Tag Format (2<sup>nd</sup> Byte of Data Block)**

Extended Tag Codes	Type of Data Block
0	Video Capability Data Block
1	Vendor-Specific Video Data Block
2	Reserved for VESA Video Display Device Information Data Block
3	Reserved for VESA Video Data Block
4	Reserved for HDMI Video Data Block
5	Colorimetry Data Block
6...15	Reserved for video-related blocks
16	CEA Miscellaneous Audio Fields
17	Vendor-Specific Audio Data Block
18	Reserved for HDMI Audio Data Block
19...31	Reserved for audio-related blocks
32...255	Reserved for general

**Table 43 CEA Data Block Tag Codes**

Any data block with an Extended Tag in the 0 to 15 range indicates strictly video-related characteristics of the display. Any repeater device that re-transmits a video stream from a source to a sink without any modification of the video timing or video data or video-related InfoFrame(s) shall also pass every such data block upstream, that is, the repeater shall copy the contents of the data block(s) from the downstream sink's EDID to the repeater's own upstream EDID.

Any data block with an Extended Tag in the 16 to 31 range indicates strictly audio-related characteristics of the display. Any repeater device that re-transmits an audio stream from a source to a sink without any modification of the audio timing or audio data or audio-related InfoFrame(s) shall also pass every such data block upstream, that is, the repeater shall copy the contents of the data block(s) from the downstream sink's EDID to the repeater's own upstream EDID.

Repeaters shall not copy the contents of any other data block from a downstream EDID to their own upstream EDID unless the characteristics of the sink indicated by that data block are known to be also true for the repeater device or the combination of the repeater and downstream device. This also applies to the original Vendor-Specific Data Block (Data Block Tag = 3); if the repeater does not recognize the vendor ID or does not understand the entire contents of that block, it shall not be copied into the repeater's EDID.

### 7.5.1 Video Data Block

When a Version 3 CEA Extension is provided in the sink's EDID data structure, a short video descriptor shall be provided for each CEA video format supported by the sink. The format of the short video descriptor shall conform to that shown in Table 44. The lower 7-bits are an index associated with the video format supported. These indexes are the same as those used in the AVI InfoFrame and are shown in Table 4. All DTDs and SVDs shall be listed in order of priority; meaning that the first is the one that the display manufacturer has identified as optimal. The most significant bit declares whether the format is a native format of the display (native = 1, not native = 0). Typically, there is a single SVD, with its native bit set. Sources should not necessarily convert video formats to a native format, but should follow recommendations for using pass-through and preferred timing (see Section 7.2.3).

Byte#	bits							
	7	6	5	4	3	2	1	0
1	Native	Video Identification Code						

**Table 44 Short Video Descriptor**

### 7.5.2 Audio Data Block

If audio is supported in the sink, as indicated by the basic audio support bit in the Version 3 CEA EDID Descriptor, then CEA short audio descriptors shall be used to declare which (if any) audio formats are supported in addition to basic audio. If only basic audio is supported, no Short Audio Descriptors are necessary.

The Short Audio Descriptor shall conform to the formats given in Table 45 through Table 49 as a function of the Audio Format Code. Several types of audio may be supported, but each one shall be listed in its own short audio descriptor with its designated code and the associated information. The list of Audio Format Code values is given in Table 24 and Table 26.

Each Short Audio Descriptor is 3-bytes long. There can be up to 31 bytes following any tag, therefore there may be up to 10 Short Audio Descriptors in the Audio Data Block.

The format of the third byte is determined by the Audio Format Code contained in the first byte as shown in Table 45 through Table 49. One format code is used for uncompressed audio (i.e., Linear PCM), the others are used for compressed audio (e.g., AC-3, MPEG2, DTS, etc.). For some compressed formats, byte 3 is further defined in other format-specific documents.

Byte#	bits							
	7	6	5	4	3	2	1	0
1	F17=0	Audio Format Code = 0001				Max Number of channels - 1		
2	F27=0	192 kHz	176.4 kHz	96 kHz	88.2 kHz	48 kHz	44.1 kHz	32 kHz
3	F37=0	F36=0	F35=0	F34=0	F33=0	24 bit	20 bit	16 bit

Table 45 CEA Short Audio Descriptor for Audio Format Code = 1 (LPCM)

Byte#	bits							
	7	6	5	4	3	2	1	0
1	F17=0	Audio Format Code				Max Number of channels - 1		
2	F27=0	192 kHz	176.4 kHz	96 kHz	88.2 kHz	48 kHz	44.1 kHz	32 kHz
3	Maximum bit rate divided by 8 kHz							

Table 46 CEA Short Audio Descriptor for Audio Format Codes 2 to 8

Byte#	bits							
	7	6	5	4	3	2	1	0
1	F17=0	Audio Format Code				Max Number of channels - 1		
2	F27=0	192 kHz	176.4 kHz	96 kHz	88.2 kHz	48 kHz	44.1 kHz	32 kHz
3	Audio Format Code dependent value.							

Table 47 CEA Short Audio Descriptor for Audio Format Codes 9 to 13

Byte#	bits							
	7	6	5	4	3	2	1	0
1	F17=0	Audio Format Code=1110				Max Number of channels - 1		
2	F27=0	192 kHz	176.4 kHz	96 kHz	88.2 kHz	48 kHz	44.1 kHz	32 kHz
3	Reserved				Profile			

Table 48 CEA Short Audio Descriptor for Audio Format Code 14 (WMA Pro)

Byte#	bits							
	7	6	5	4	3	2	1	0
1	F17=0	Audio Format Code=1111				Max Number of channels - 1		
2	F27=0	192 kHz	176.4 kHz	96 kHz	88.2 kHz	48 kHz	44.1 kHz	32 kHz
3	Audio Format Code Extension				F32=0	F31=0	F30=0	

Table 49 CEA Short Audio Descriptor for Audio Format Code 15 (extension)

The Audio Format Codes used in each Short Audio Descriptor shall be as defined for CT0-CT3 in Table 24 except that the value zero shall be reserved. The Audio Format Code Extension shall be as defined for CXT0-CXT4 in Table 26. F32, F31, and F30 are future bits and shall be set to zero.

### 7.5.3 Speaker Allocation Data Block

If the sink supports multi-channel uncompressed digital audio as indicated in the Audio Data Block, then the Speaker Allocation Data Block shall be included in the CEA Extension. It is recommended that the sink include a valid Speaker Allocation Data Block if it supports any type of digital audio (including Basic Audio), but this is not required.

The payload of the Speaker Allocation Data Block is shown in Table 50. This payload is preceded by a Tag Code Byte that includes a tag equal to 4 and a length of 3 (see Table 39 and Table 41). The first byte of the Data block payload consists of eight bits and the second byte of the Data block payload consists of three bits and five reserved bits. The sink signifies that a speaker, or pair of speakers, is present by setting the bit associated with that speaker or pair of speakers to one. The speaker designations are the same as is used in the Audio InfoFrame (see Figure 6 and Table 27). The Front Left and Front Right

channels are not independent and are shown as FL/FR in the table. The Front Left Center and Front Right Center (FLC/FRC) Rear Left and Rear Right (RL/RR), Rear Left Center and Rear Right Center (RLC/RRC), Front Left Wide and Front Right Wide (FLW/FRW), and Front Left High and Front Right High (FLH/FRH) channels are also not independent.

Byte#	bits							
	7	6	5	4	3	2	1	0
1	FLW/FRW	RLC/RRC	FLC/FRC	RC	RL/RR	FC	LFE	FL/FR
2	F27=0	F26=0	F25=0	F24=0	F23=0	FCH	TC	FLH/FRH
3	F37=0	F36=0	F35=0	F34=0	F33=0	F32=0	F31=0	F30=0

**Table 50 Speaker Allocation Data Block Payload**

#### 7.5.4 Vendor Specific Data Block

The content of the Vendor Specific Data Block is defined in Table 39.

A sink may contain one or more Vendor-Specific Data Blocks (VSDB) to indicate proprietary information that may be of interest to the vendor's own sources.

The VSDB shall contain the 3 bytes of the IEEE OUI as well as any additional payload bytes needed.

NOTE—HDMI sinks use one version of the VSDB to indicate HDMI-specific characteristics of the sink. Additional VSDBs, such as those with the vendor's own IEEE OUI, may also be included in the E-EDID.

#### 7.5.5 Colorimetry Data Block

The Colorimetry Data Block indicates support of specific extended colorimetry standards and gamut-related as yet, undefined metadata. Details regarding the contents of the Colorimetry Data Block are provided in Table 51, Table 52 and Table 53.

Byte 3 is allocated for Colorimetry data. The flags for bits 0 through 4 are defined for colorimetry based upon the IEC 61966-2 series of standards. The definitions of the colorimetry flags are shown in Table 52. Setting a colorimetry flag to one shall indicate that the sink is capable of displaying pictures encoded in that colorimetry.

Byte#	bits							
	7	6	5	4	3	2	1	0
1	Tag Code (0x07)			Length of following data block (in bytes) (0x03)				
2	Extended Tag Code (0x05)							
3	F37=0	F36=0	F35=0	Adobe <sub>RGB</sub>	Adobe <sub>YCC601</sub>	sYCC <sub>601</sub>	xvYCC <sub>709</sub>	xvYCC <sub>601</sub>
4	F47=0	F46=0	F45=0	F44=0	MD3	MD2	MD1	MD0

**Table 51 Colorimetry Data Block**

Flag	Colorimetry
xvYCC <sub>601</sub>	Standard Definition Colorimetry based on IEC 61966-2-4 [5]
xvYCC <sub>709</sub>	High Definition Colorimetry based on IEC 61966-2-4 [5]
sYCC <sub>601</sub>	Colorimetry based on IEC 61966-2-1/Amendment 1 [35]
Adobe <sub>YCC601</sub>	Colorimetry based on IEC 61966-2-5 [33], Annex A
Adobe <sub>RGB</sub>	Colorimetry based on IEC 61966-2-5 [33]

**Table 52 Data Byte 3 Colorimetry Support Flags**

Byte 4, bits 0 through 3 are listed in Table 53 and designated for future gamut-related metadata. As yet undefined, this metadata is carried in an interface-specific way.

Flag	Metadata
MD0	Future metadata profile
MD1	Future metadata profile
MD2	Future metadata profile
MD3	Future metadata profile

Table 53 Data Byte 4 Colorimetry Metadata Support Flags

### 7.5.6 Video Capability Data Block

The Video Capability Data Block (VCDB) allows a display to declare default, fixed, or InfoFrame-controlled overscan/underscan and quantization range (see Table 54). Separate overscan/underscan handling capabilities may be declared for Preferred, IT, and CE video format categories.

NOTE—The VCDB payload currently only contains a single byte in addition to the Extended Tag Code, while future versions may contain additional bytes. The source should ignore such additional bytes (when present) and continue to parse the single byte as defined in Table 54 and Table 43.

Byte#	bits							
	7	6	5	4	3	2	1	0
1	Tag Code (0x07)				Length of following data block (in bytes) (0x02)			
2	Extended Tag Code (0x00)							
3	QY	QS	S_PT1	S_PT0	S_IT1	S_IT0	S_CE1	S_CE0

Table 54 Video Capability Data Block (VCDB)

QY	Quantization Range (Applies to YCC only)	QS	Quantization Range Selectable (Applies to RGB only)	S_PT1	S_PT0	PT Overscan/ underscan behavior (Applies to the preferred video format)	S_IT1	S_IT0	IT Overscan/ underscan behavior (Applies to IT video formats)	S_CE1	S_CE0	CE Overscan/ underscan behavior (Applies to CE video formats)
0	No Data	0	No Data	0	0	No Data (refer to <b>S_CE</b> or <b>S_IT</b> fields)	0	0	IT video formats not supported	0	0	CE video formats not supported
1	Selectable (via AVI YQ)	1	Selectable (via AVI Q)	0	1	Always Overscanned	0	1	Always Overscanned	0	1	Always Overscanned
				1	0	Always Underscanned	1	0	Always Underscanned	1	0	Always Underscanned
				1	1	Supports both over- and underscan	1	1	Supports both over- and underscan	1	1	Supports both over- and underscan

Table 55 Video Capability Descriptor Data Byte 3

Displays do not always present the entire incoming picture to the viewer. Sometimes displays overscan the incoming video format such that pixels along the periphery of the picture are masked (occluded). For example, a display may purposely mask a portion of the picture to hide distracting content (received from



a source) or the unsightly edges of a raster. In either case, what the viewer sees is either an underscanned or overscanned picture, which may either include (in the case of underscanning) the whole incoming picture or (in the case of overscanning) a somewhat occluded picture.

CE application specific displays (e.g. DTVs) typically overscan all video formats, while IT application specific displays (e.g. computer displays) typically underscan all video formats. Multipurpose displays typically adapt to the incoming signal by either overscanning or underscanning depending on the type of video format received. The **S\_CE**, **S\_IT**, and **S\_PT** values allow a display to formally declare its overscan/underscan options by CE, IT, and Preferred video format category (see Table 55).

Each of the three **S\_xx** fields indicate whether the display, for all video formats in that category, always overscan those video formats, always underscan those formats or support both overscanning and underscanning of those formats. Indications shall be accurate for all video format categories – so long as a VCDB is present in the EDID. If the display does not support the reception of one of the two main video format categories (CE and IT), then the indication for the unsupported category shall be set to 00.

The display's Preferred Video Format may be either a CE or an IT video format but may have different overscan/underscan behavior than the rest of the CE or IT video formats supported by the display. If the display declares a non-zero value for the **S\_PT** (preferred timing overscan/underscan behavior) field, and the source outputs that video format, then the **S\_PT** declaration shall take precedence over both **S\_CE** and **S\_IT** declarations. If the **S\_PT** field is 0 then the overscan/underscan behavior of this format is indicated by either the **S\_CE** or **S\_IT** fields, depending on whether the Preferred Video Format is a CE or IT video format.

If the display declares that it can support both overscan and underscan for a video format category and the source outputs that type, then the display shall either automatically overscan or underscan (in response to the AVI InfoFrame S field) or provide user options of selecting an overscan or an underscan mode. If operating in an automatic mode, the display shall overscan the incoming picture if it receives AVI S=1 and it shall underscan if it receives AVI S=2. The source shall always set the AVI S field correctly if that information is known by the source. If the display receives no AVI or AVI S=0, then the display should overscan CE video formats and underscan IT video formats by default but may provide a user-selectable alternative behavior.

If the display does not provide a VCDB then the source should assume that CE video formats are overscanned by the display and that IT video format behavior is indicated by CEA Extension byte 3 bit 7 (underscan). If underscan=1 then the source should assume that IT video formats are underscanned and if underscan=0, that IT video formats are overscanned.

If the source outputs a video format that can be underscanned by the display, then the source may safely place essential content at the very edge of the signaled picture and the display shall ensure that the entire signaled picture is visible.

When outputting a video format that is always overscanned by the display, IT sources (which normally render interactive menus and window controls along the periphery of the transmitted picture) should confine essential content to a smaller area of the signaled picture - to ensure the viewer operability. Media-centric sources, on the other hand, which fill the signaled picture with (decompressed) broadcast or prerecorded content - precomposed for an overscanned display, should simply pass-through such content without further processing.

The exact dimensions of the overscanned picture may vary and are not specified in CEA-861-E.

For RGB colorimetry, CEA-861-E supports both limited ( $16 \times 2^{(N-8)}$  to  $235 \times 2^{(N-8)}$ ) and full ( $0$  to  $255 \times 2^{(N-8)}$ ) range data when receiving video with RGB color space. By default, RGB pixel data values should be assumed to have a limited range when receiving a CE video format and a full range when receiving an IT format (see Section 5). The QS (AVI Q support) bit of byte 3 allows a display to declare that it supports the reception of either type of quantization range for any video format, under the direction

of InfoFrame Q data (see Section 6.4 for information concerning bits Q1 and Q0). This allows a source to override the default quantization range for any video format.

If the sink declares a selectable RGB Quantization Range (QS=1) then it shall expect limited range pixel values if it receives Q=1 and it shall expect full range pixel values if it receives Q=2 (see section 6.4). For other values of Q, the sink shall expect pixel values with the default range for the transmitted video format.

When received content encoded in sYCC<sub>601</sub> (IEC 61966-2-1/Amendment 1 [35]), Adobe<sub>YCC601</sub>, and Adobe<sub>RGB</sub> (IEC 61966-2-5 [33]) colorimetry, CEA-861-E supports both limited ( $16 \cdot 2^{(N-8)}$  to  $235 \cdot 2^{(N-8)}$ ) and full (0 to  $255 \cdot 2^{(N-8)}$ ) quantization ranges. By default, sYCC<sub>601</sub> and Adobe<sub>YCC601</sub> YCC pixel data values should be assumed to have a limited range when receiving a CE video format and a full range when receiving an IT format. The QY (AVI YQ support) bit of byte 3 allows a display to declare that it supports the reception of either type of quantization range for any video format, under the direction of AVI InfoFrame YQ data (see Section 6.4 for information concerning bits YQ1 and YQ0). This allows a source to override the default quantization range for any video format.

If the sink declares a selectable YCC Quantization Range (QY=1), then it shall expect limited range pixel values if it receives AVI YQ=0 and it shall expect full range pixel values if it receives AVI YQ=1 (see section 6.4). For other values of YQ, the sink shall expect pixel values with the default range for the transmitted video format.

### 7.5.7 Vendor-Specific Video Data Block

The Vendor Specific Video Data Block (VSVDB) allows a display to declare up to 27-bytes of vendor-defined video capabilities-related data (see Table 56). A sink may contain one or more VSVDBs to indicate proprietary information that may be of interest to the vendor's own sources. The VSVDB shall contain the 3 bytes of the vendor's IEEE OUI as well as any additional payload bytes needed.

Byte#	bits							
	7	6	5	4	3	2	1	0
1	Tag Code (0x07)			Length (L) = number of bytes following this byte				
2	Extended Tag Code (0x01)							
3	24-bit IEEE Registration Identifier (least significant byte first)							
4								
5								
6 through L+1	Vendor Specific Video Data Block Payload (L-4 bytes)							

**Table 56 Vendor-Specific Video Data Block (VSVDB)**

### 7.5.8 Vendor-Specific Audio Data Block

The Vendor Specific Audio Data Block (VSADB) allows a display to declare up to 27-bytes of vendor-defined audio capabilities-related data (see Table 57). A sink may contain one or more VSADBs to indicate proprietary information that may be of interest to the vendor's own sources. The VSADB shall contain the 3 bytes of the vendor's IEEE OUI as well as any additional payload bytes needed.

Byte#	bits							
	7	6	5	4	3	2	1	0
1	Tag Code (0x07)			Length (L) = number of bytes following this byte				
2	Extended Tag Code (0x11)							
3	24-bit IEEE Registration Identifier (least significant byte first)							
4								
5								
6 through L+1	Vendor Specific Audio Data Block Payload (L-4 bytes)							

**Table 57 Vendor-Specific Audio Data Block (VSADB)**

## Annex A Baseline Example EDID and Detailed Timing Descriptors (Informative)

CEA-CEB14 was originally written as a companion document for CEA-861-B. The intent of CEB14 was to provide a baseline example EDID for features and functions contained in CEA-861-B. For convenience, CEB14 was later subsumed into CEA-861-C as an informative Annex A. With the evolution of features and functions, Annex D was added to CEA-861 to convey information about conceptual EDID structures. In all cases, the example EDID contained in Annexes A, and D were not meant to illustrate all conceivable combinations for data block types or lengths.

Annex A addresses issues related to the VESA Extended Display Identification Data (EDID) tables utilized within CEA-861-E.

Annex A provides examples and guidance to manufacturers that utilize CEA-861-E; however included in this Annex are several normative requirements identified by the "shall" verb. Specifically, this guidance is for the implementation of EDID tables. Primarily, the motivation is to help insure interoperability between various sources and sinks. Annex A should in no way prohibit consumer device manufacturers from including additional features, and Annex A should not be interpreted as stipulating any form of upper limit to EDID features.

### A.1 Background

CEA-861-E follows requirements in the VESA Enhanced Extended Display Identification Data Standard (E-EDID). EDID tables exist within the sink and are used to declare its capabilities to sources. The source uses these declared capabilities to determine the appropriate signal parameters to send across the interface for consumption by the sink.

Possibly, there are varied and inconsistent ways to create EDID tables and therefore, a common methodology is desirable to help insure interoperability between various sink and sources. The purpose of Annex A is to provide a consistent and understandable guideline for creating EDID tables that reside within consumer electronics products. Consequently, Annex A does not address implementations that utilize repeaters.

### A.2 EDID Tables

CEA-861-E requires use of the VESA EDID version 1, revision 3 data structure. Previous versions of EDID are not supported and such use is deprecated. EDID Version 1, Revision 3 requires use of certain features for Computer Displays. Despite these requirements, some features are not applicable to certain display technologies and applications. For example, the Monitor Range Limits descriptor and support of the Generalized Timing Formula apply to CRT based multi-scan systems and not flat panel or most consumer electronics equipment. For consumer electronics devices (CE devices) the application is limited to a simple declaration of the sink's capabilities and attributes. This section provides an outline describing the various blocks that reside with the EDID structure.

#### A.2.1 EDID Table Construction

The table construction is divided into blocks dedicated to specifying various attributes. Each block is 128 bytes in length. Block 0 is mandatory and the following blocks are called "extensions". The extensions are limited to 254 blocks.

It is possible to use the first extension as a data block or as an index (EDID Block Map Extension) that lists more than one extension. When only one extension is required, it is called Block 1 and is used for data. In cases where more than one extension is required, the first extension or Block 1 is used as an index map that lists extension locations. Additional extensions are referred to as Blocks, such as Block 2, Block 3, and so on.

Each extension contains a Block Tag that declares the contents of each extension. Sources should read Block 0 (at address 0x7E), check for multiple extensions, identify each block or extension, and be able to appropriately interpret the data contained therein. Users should be knowledgeable of defined Tags contained within section 2.2.1.4 of the VESA E-EDID standard.

Sources should read all extensions and Block Tags. CEA Extension Version 1 or Version 3 specifies additional video formats as necessary. There are three possible versions of the CEA Extension and sources should read the contents of the extension even if they cannot recognize the version number. This is to insure that the Detailed Timing Descriptors are read.

For CE devices, the number of extensions or blocks is dependent upon the amount of supported video formats and features. Annex A shows one extension containing four Detailed Timing Descriptors (see Section A.3).

### A.2.2 Detailed Explanation of EDID Block Zero

For this discussion, block zero and subsequent extension blocks are divided into smaller sections, each receiving an explanation of terminology and use. The contents in each section are a possible example of a typical CE device application.

A data format protocol is required to properly utilize the various blocks. Data within the various blocks is placed in fields with varying bit lengths. These lengths range from one bit to two bytes. The data length convention is defined and shown in Table 58

Bit range	Convention
1 ~ 7 bits	Binary, consecutive sequence
8 bits (byte)	Binary, according to location
9 ~ 15 bits	Binary, sequence according to field
16 bits (two bytes)	Binary, LSB first
Greater than two bytes: (Character string)	ASCII code, consecutive string order, ex: HDTV = 0x48, 0x44, 0x54, 0x56

Table 58 Standard Data Lengths

### A.2.3 Block Zero Header Section

The header is comprised of eight addresses, 0x00 through 0x07, containing a simple binary data pattern that is used to identify the EDID table. There is one byte per address for a total of eight bytes. Address locations 0x00 and 0x07 contain data values 0x00 and locations 0x01 through 0x06 contain 0xFF as data values. CEA-861-E requires this data. This header is used to determine the beginning of an EDID structure in a sink. See Table 59.

Address Hex	Example Data		Format	Remarks
	Hex	Dec		
0x00	0x00	0	Binary	These fixed values are <b>REQUIRED</b> to properly identify start of EDID table data
0x01	0xFF	255		
0x02	0xFF	255		
0x03	0xFF	255		
0x04	0xFF	255		
0x05	0xFF	255		
0x06	0xFF	255		
0x07	0x00	0		

Table 59 Block Zero Header

Although future versions of EDID may not contain an 8-byte header at the beginning of Block 0, compliant devices are expected to use this header. However, presence of the header is not an indication that the following EDID data is valid. A checksum byte is provided for the purpose of verifying that a device's EDID structure has been correctly read. See Section A.2.11 for more detail.

### A.2.4 Vendor / Product Identification

This section's example starts and ends with address locations 0x08 and 0x11. Byte allocation for each location is as follows:

0x08 ~ 0x09 are a two byte EISA ID for Manufacturer Name and should contain a valid identification number. Data for these bytes is based upon compressed ASCII, for example: "CEA" is created by using five-bit codes, where "C" = 00011. "E" = 00101, and "A" = 00001. Table 3 illustrates the address location and sample data for Manufacturer's Name, which is "CEA". For information on how to obtain an EISA ID, see Microsoft Plug and Play ID - PNPID Request [69].

0x0A ~ 0x0B are two bytes available for Product code; the manufacturer determines this code.

0x0C ~ 0x0F are four bytes to be used for product Serial Number, which is defined as a 32-bit serial number. There is no specific requirement defined for the data or format of the serial number. This field should be zero if the serial number is contained in an ASCII serial number descriptor (see Section A.2.17). CEA-861-E implementations should use 0x00 as padding for the Block 0 serial number if no serial number is provided in Block 0.

For the source, if an ASCII Serial Number Descriptor is included in the sink, then the source should ignore the Serial Number field in Block 0. If no ASCII Serial Number Descriptor is present, then the field may have meaning. Ignore this block if all bytes are 0x00.

0x10 is one byte for Week of Manufacture. The designated values for this field range from 1 to 53. Values greater than 53 are not recognized. Zero may be used when no week is designated. The manufacturer determines the week numbering system. Manufacturers should use a system in which the week number's integer value increases as the year progresses. If a manufacturer chooses to declare only the Model Year (in the field "Year of Manufacture"), then 0xFF shall be placed in Address 10 (Week of Manufacture).

0x11 is one byte representing Year of Manufacture. This value is determined by the actual year of production minus 1990. For example: 2002 – 1990 = 12 or 0x0C. See Table 60.

Address Hex	Example Data		Description	Remarks
	Hex	Dec		
0x08	0x0C	12	Manufacturer Name	using EISA ID Example = CEA
0x09	0xA1	161		
0x0A	0x12	18	Product Code	Used to differentiate between different models from the same manufacturer. In this example Product Code=0x3412
0x0B	0x34	52		
0x0C	0x56	86	Serial Number	Optional. The serial number can also be stored in a separate descriptor block (see Section A.2.17). In this example, the Serial Number=0xBC9A7856.
0x0D	0x78	120		
0x0E	0x9A	154		
0x0F	0xBC	188		
0x10	0x10	16	Week of Manufacture	If this field is unused, the value should be set to 0. If the next field is used for Model Year, then 0xFF should be set. In this example Manufacture Week=16
0x11	0x0C	12	Year of Manufacture/Model Year	Example = Manufactured Year=2002

**Table 60 Vendor / Product Identification; Showing Manufacturer Week and year**

### A.2.5 EDID Version

The version of EDID is declared in addresses 0x12 and 0x13. Each address contains one byte of data. The first address contains the version number and the second, the revision number. In the case of EDID version 1, revision 3, the value one (0x01) is placed in the first location (i.e., 0x12) and three (0x03) placed in the second area (0x13). No other numbers are allowed for this space. If other numbers are placed in this area, the source may disregard the whole EDID table. See Table 61.

Address Hex	Example Data		Format	Remarks
	Hex	Dec		
0x12	0x01	1	Binary	Version #
0x13	0x03	3		Revision #

**Table 61 Vendor / Product Identification**

### A.2.6 Basic Display Parameters and Features

Basic Display Parameters and Features are defined as Video Input Definition, Maximum Horizontal Image Size, Maximum Vertical Image Size, Display Transfer Characteristic (Gamma), and Feature Support. In the following example, each item is allocated one byte and the address range is from 0x14 to 0x18.

0x14: Video Input Definition is located at 0x14 and used to identify the output configuration required by the sink. For digital displays, including CE devices, the recommended setting is 0x80. This value is used to declare that the device supports a digital interface.

0x15 ~ 0x16: The Maximum Horizontal Image Size and Vertical Image Size fields (bytes 0x15, 0x16) are used to indicate the sink's screen size and aspect ratio. When known, the maximum physical dimensions of the effective display area should be provided (in these fields, in cm). An important use of these fields is to indicate the aspect ratio of the actual screen. If the aspect ratio of the maximum image size is known, the ratio of the Maximum Size fields should equal that aspect ratio, even if the maximum image size is unknown or variable across different device configurations (such as in a projection system).

The following rules should be used in filling out the Maximum Image Size fields:

- a) If the aspect ratio is known and the display size is known, then the actual size should be indicated, to the nearest cm.
- b) If the aspect ratio is known but the size is unknown, any values corresponding to a typical or expected configuration of the display can be used, but the ratio of the Max Horizontal and Vertical fields shall be equal to the aspect ratio.
- c) If the aspect ratio is unknown, or it is desired that it not be discoverable, then values of 0, 0 should be used.

If the fields are set to zero, the source should not make any assumptions regarding screen size or aspect ratio.

In typical configurations, the image sizes described in each DTD (in bytes at offsets 0x0C, 0x0D, 0x0E, in mm) should correlate to the values in the Maximum Size fields. For instance, a 160 cm by 90 cm display would indicate 1600 mm x 900 mm for all 16:9 video formats and 1200 mm x 900 mm for all 4:3 formats.

For example, data entry into the 0x15, 0x16 EDID bytes may be as summarized in Table 62.

Category of Display	EDID Physical Horizontal Screen Size (cm)	EDID Physical Vertical Screen Size (cm)	Physical AR to be calculated by the source (unitless)
Direct View	Enter dimension in cm	Enter dimension in cm	Source Divides H by V
Rear Projector	Enter dimension in cm	Enter dimension in cm	Source Divides H by V
Front Projector (enter either data row at option of implementer)	Typical dimension in cm	Typical dimension in cm	Source Divides H by V
	Enter 0x00	Enter 0x00	AR is undefined

**Table 62 Example 0x15, 0x16 EDID Screen Size Data and Certain Display Categories**

0x17: Display Transfer Characteristics (Gamma) could be used by the source to tailor the video output according to the display device's gamma. The concept of declaring gamma has to do with personal computer CRT displays that accept non-gamma corrected signals. Digital and analog television video signals are gamma corrected according to established industry practices and thus the need to declare CRT gamma is not always necessary. However, this is needed for Personal Computer CRT applications. Although the source possibly may not need to use the display's gamma value, the correct gamma value of the display device should be present. Since some television CRTs commonly have similar gamma, the value 2.2 is used in this example. The gamma value, itself, is not inserted into the table. Instead, a value equal to  $(\text{gamma} \times 100) - 100$  is inserted.

0x18: Feature Support consists of 8 bits that identify various display or sink parameters. These include power savings modes based upon VESA Display Power Management Signaling Standard (DPMS), Display Type, Standard Default Color Space, Preferred Timing Mode, and Default Generalized Timing Formula (GTF). In most cases, none of this information is relevant to CE devices and personal computer displays, since GTF is not commonly used. In Table 63, the function of each bit is indicated.



Bits	Feature	Description															
7	Standby	1 = Standby supported, 0 = not supported															
6	Suspend	1 = Suspend supported, 0 = not supported															
5	Active Off	1 = Active Off supported, 0 = not supported															
4 ~ 3	Display Type (4:3)	<table border="1"> <thead> <tr> <th>Bit 4</th> <th>Bit 3</th> <th></th> </tr> </thead> <tbody> <tr> <td>1</td> <td>1</td> <td>Undefined</td> </tr> <tr> <td>1</td> <td>0</td> <td>Non-RGB Display</td> </tr> <tr> <td>0</td> <td>1</td> <td>RGB Display</td> </tr> <tr> <td>0</td> <td>0</td> <td>Monochrome Display</td> </tr> </tbody> </table>	Bit 4	Bit 3		1	1	Undefined	1	0	Non-RGB Display	0	1	RGB Display	0	0	Monochrome Display
Bit 4	Bit 3																
1	1	Undefined															
1	0	Non-RGB Display															
0	1	RGB Display															
0	0	Monochrome Display															
2	Color Space	1 = sRGB supported, 0 = not supported															
1	Preferred Timing	1 = preferred timing is indicated in first detailed timing block (required), 0 = not indicated (not allowed)															
0	Default GTF	1 = GTF supported, 0 = not supported															

**Table 63 Feature Support Detail**

The minimum that a CE device should declare is Display Type and Preferred Timing. In this example, 0x0A is used to designate a RGB display type and a preferred timing descriptor. The preferred timing descriptor bit shall be set to one and address locations 0x36 through 0x47 shall contain the Preferred Format. No other data is allowed in those locations. All DTDs and SVDs shall be listed in order of priority; meaning that the first is the one that the display manufacturer has identified as optimal; however, in the context of total system optimization, source implementers are advised to follow guidance provided in Section 7.2.3.

Address Hex	Example Data		Description	Remarks
	Hex	Dec		
0x14	0x80	128	Video Input Definition	Example indicates: Digital; VESA DFP1X: not compatible
0x15	0x50	80	Max. Horizontal Image Size in cm	CRT devices should list parameters. However, due to projector and auto sizing devices, the system should not make any assumption regarding display size if data not supplied. This example indicates a 16:9 aspect ratio device.
0x16	0x2D	45	Max. Vertical Image Size in cm	Optional; See above; This example indicates a 16:9 aspect ratio device.
0x17	0x78	120	Gamma: (gamma x 100)-100 = value	Example is: (for gamma = 2.2) (2.2 x 100)-100 = 120
0x18	0x0A	10	Feature Support	Example indicates: RGB color Display type; Preferred timing: first detailed timing block; GTF timing: not supported; Standby mode: not supported; Suspend mode: not supported; Active off: not supported

**Table 64 Basic Display Parameters and Features Block**

### A.2.7 Color Characteristics

Color Characteristics provides information about the display device's chromaticity and color temperature parameters (white temperature in degrees Kelvin).

Table 66 shows EDID addresses 0x19 through 0x22, which contain data used to describe various chromaticity characteristics; this example uses 9300° K as the white color temperature. These characteristics are represented by 10-bit binary fractions. Bits nine through two of a particular characteristic are stored as a single byte in addresses 0x1B ~ 0x22. Bits one to zero of that corresponding characteristic are paired with the lower order bits of other color characteristics to form bytes and are stored in addresses 0x19 ~ 0x1A. Table 66 shows the arrangement of these fractional binary values by EDID address. In the E-EDID standard, a decimal fraction such as 0.625 is represented by a 10-bit binary value. Each of the bit positions from left to right in the binary value represent powers of 2 from  $2^{-1}$  ~  $2^{-10}$ . Table 65 illustrates an example decimal to binary conversion used for these color characteristics. Further explanation can be found in VESA E-EDID [10] Section 3.7.

Value	10-bit Binary	Conversion
0.625	1010000000	0.625
0.340	0101011100	0.33984375
0.155	0010011111	0.1552734375

**Table 65 Binary to Decimal Conversion Example**

How the table is filled is dependent upon the setting of address 0x18 in the Feature Support section. If sRGB is selected, then all values should be set in accordance to sRGB definition. For displays not supporting the sRGB definition, the example in Table 66 is applicable.

Address Hex	Example Data		Description	Remarks
	Hex	Dec		
0x19	0x0D	13	Red/Green Low Bits	Bits 1~0 of RxRyGxGy = 00001101
0x1A	0xC9	201	Blue/White Low Bits	Bits 1~0 of BxByWxWy = 11001001
0x1B	0xA0	160	Red-x	Bits 9~2 of 10-bit value 0.625 = 10100000
0x1C	0x57	87	Red-y	Bits 9~2 of 10-bit value 0.340 = 01010111
0x1D	0x47	71	Green-x	Bits 9~2 of 10-bit value 0.280 = 01000111
0x1E	0x98	152	Green-y	Bits 9~2 of 10-bit value 0.595 = 10011000
0x1F	0x27	39	Blue-x	Bits 9~2 of 10-bit value 0.155 = 00100111
0x20	0x12	18	Blue-y	Bits 9~2 of 10-bit value 0.070 = 00010010
0x21	0x48	72	White-x	Bits 9~2 of 10-bit value 0.283 = 01001000
0x22	0x4C	76	White-y	Bits 9~2 of 10-bit value 0.298 = 01001100
Note—This data based on a CRT Display with a white point of ~9300° K (X = 0.283; Y = 0.298)				

**Table 66 Color Characteristics Block**

Multiple white points can be specified using the Color Point Monitor Descriptor. However, there is no way to correlate to the individual video formats. Therefore chromaticity specified in Block 0 should be associated with the display device's characteristics; however the White Point data does not. The source should not rely on the colorimetry information contained in this part of the EDID data structure for CEA-861-E formats. This recommended practice suggests the source use the colorimetry that has been associated with the format in CEA-861-E when possible. Note that this may not be possible because the source probably just passes on the video stream.

### A.2.8 Established Timings

In the example in Table 67, addresses 0x23 through 0x25 are used to declare Established Timings. Established Timings are computer display timings recognized by VESA. This table is also used to indicate that the established timings were adjusted and verified at the factory, which means these timings are supported and correctly rendered on the display.

In the example, Table 67, address 0x23 contains the default 640x480p timing and the remaining addresses are not used to list any other timings. Personal Computers, DVI-1.0 [4], Open LDI [8], CEA-861-E require 640x480p as a default timing format. This is to insure that all source and sinks commonly support one format. Other supported or preferred timings may be described in the Standard Timing (see A.2.9) or Detailed Timing Descriptors (see A.2.10). Use of other timings is permissible. See VESA E-EDID Section 3.8.1 [10] for a list of possible formats.

Address Hex	Example Data		Description	Remarks
	Hex	Dec		
0x23	0x20	32	Established Timing 1	640x480 @ 60Hz
0x24	0x00	0	Established Timing 2	None
0x25	0x00	0	Manufacturer's Timing	None

**Table 67 Established Timings Block**

### A.2.9 Standard Timing ID #1 – 8

Standard timings are those either recognized by VESA through the VESA Discrete Monitor Timing or Generalized Timing Formula standards. The display device should list timings supported. The address range for this portion of the example EDID table is 0x26 through 0x35 and the data length is two bytes.

Since CE devices possibly may not support, other than the required 640x480p format, any of the VESA timings or GTF, the example in Table 68 does not contain any timing information. When no timings are declared, it is necessary to fill each unused byte, of the byte pairs, with 0x01 as padding. Other padding values are not recognized.

Address Hex	Example Data Hex Dec		Description	Remarks
0x26	0x01	1	Standard Timing ID #1	PC Application
0x27	0x01	1		
0x28	0x01	1	Standard Timing ID #2	PC Application
0x29	0x01	1		
0x2A	0x01	1	Standard Timing ID #3	PC Application
0x2B	0x01	1		
0x2C	0x01	1	Standard Timing ID #4	PC Application
0x2D	0x01	1		
0x2E	0x01	1	Standard Timing ID #5	PC Application
0x2F	0x01	1		
0x30	0x01	1	Standard Timing ID #6	PC Application
0x31	0x01	1		
0x32	0x01	1	Standard Timing ID #7	PC Application
0x33	0x01	1		
0x34	0x01	1	Standard Timing ID #8	PC Application
0x35	0x01	1		

**Table 68 Standard Timing ID Block**

### A.2.10 Detailed Timing Descriptor Block

The detailed timing section is 72 bytes in length and can be divided into four descriptor blocks, which are each 18 bytes. In the following example, the address ranges for these four blocks are 0x36-0x47, 0x48-0x59, 0x5A-0x6B and 0x6C-0x7D. Each of these descriptors contains either detailed timing data (Detailed Timing Descriptor) or other specific types of data as described in the VESA E-EDID standard.

The VESA E-EDID standard allows various descriptor sequences, combinations, or repetitions and sources should handle descriptors that may appear in any order. The only prescribed constraint is that Detailed Timing Descriptors precede the two required Monitor Descriptors in Block 0. The descriptors require the presence of valid data and no fill patterns are permitted in Block 0. Therefore, the source should handle these possibilities and requirements accordingly. Blocks used for data, not detailed timing information, have a five byte identifier header that is formatted as follows: 0x00, 0x00, 0x00, <Tag #>, 0x00. For more detail regarding 18-byte descriptor tags, please refer to the VESA EDID standard section 3.10.3 [10].

The example in this document configures the four blocks in this order: First Detailed Timing Descriptor, Second Detailed Timing Descriptor, First Monitor Descriptor (Monitor Name), and Second Monitor Descriptor (Monitor Range).

#### A.2.10.1 First Detailed Timing Descriptor

The VESA E-EDID Standard [10] requires that the First Detailed Timing Descriptor be used for the most “preferred” video format and subsequent detailed timing descriptors are listed in order of decreasing preference.

Data locations within the Detailed Timing Descriptors are used to specify the video timing characteristics, image size, and contain flags for identifying interlace/non-interlace formats and sync signal polarities. Designers of source and sink need to carefully consider these types of data in all implementations.

The example in Table 69 shows the data format for a Preferred Video Format of 1920x1080i and the image size is matched to the screen size of approximately 36 inches diagonal. CEA-861-E recommends listing exact horizontal and vertical dimensions, but at least requires values that describe the aspect ratio. The source should be capable of using these dimensions to determine aspect ratio. However, some EDID implementations that do not provide horizontal and vertical dimensions for non-CEA-861-E video formats may be encountered. The flags are set to convey an interlaced format and the syncs as separate and of positive polarity.

Address Hex	Example Data Hex Dec		Description	Remarks (Refer to note below for additional details)
0x36	0x01	1	Pixel Clock	74.25 MHz
0x37	0x1D	29		
0x38	0x80	128	H Active	1920 pixels
0x39	0x18	24	H Blanking	280 pixels
0x3A	0x71	113	H Active: H Blanking	
0x3B	0x1C	28	V Active	540 lines
0x3C	0x16	22	V Blanking	22 lines
0x3D	0x20	32	V Active: V Blanking	
0x3E	0x58	88	H Sync Offset	88 pixels
0x3F	0x2C	44	H Sync Pulse Width	44 pixels
0x40	0x25	37	VS Offset: VS Pulse Width	2 lines, 5 lines
0x41	0x00	0	HS Offset: HS Pulse Width: VS Offset: VS Pulse Width	
0x42	0x20	32	H Image Size	800 mm (lower 8 bits)
0x43	0xC2	194	V Image Size	450 mm (lower 8 bits)
0x44	0x31	49	H&V Image Size	Upper 4 bits of H Size; Upper 4 bits of V Size
0x45	0x00	0	H Border	0 lines
0x46	0x00	0	V Border	0 pixels
0x47	0x9E	158	Flags	Interlaced, normal display no stereo, digital separate, Vsync polarity is positive, Hsync polarity is positive
NOTE—Some addresses above contain “composite” bytes representing high and/or low order bits or “nibbles” (4 bits of an 8-bit byte). Please refer to section 3.10.2 of the VESA E-EDID standard for details on these fields.				

**Table 69 First Detailed Timing Descriptor Block (1920x1080i Example)**

#### A.2.10.2 Second Detailed Timing Descriptor

Table 70 contains an example for the second preferred timing using the Second Detailed Timing Descriptor block. This is the EDTV 720x480p format that has a 4:3 aspect ratio.

Address Hex	Example Data Hex Dec		Description	Remarks (Refer to note below for additional details)
0x48	0x8C	140	Pixel Clock	27 MHz
0x49	0x0A	10		
0x4A	0xD0	208	H Active	720 pixels
0x4B	0x8A	138	H Blanking	138 pixels
0x4C	0x20	32	H Active: H Blanking	
0x4D	0xE0	224	V Active	480 lines
0x4E	0x2D	45	V Blanking	45 lines
0x4F	0x10	16	V Active: V Blanking	
0x50	0x10	16	H Sync Offset	16 pixels
0x51	0x3E	62	H Sync Pulse Width	62 pixels
0x52	0x96	150	VS Offset: VS Pulse Width	9 lines, 6 lines
0x53	0x00	0	HS Offset: HS Pulse Width: VS Offset: VS Pulse Width	
0x54	0x58	88	H Image Size	600 mm (lower 8 bits)
0x55	0xC2	194	V Image Size	450 mm (lower 8 bits)
0x56	0x21	33	H&V Image Size	Upper 4 bits of H Size; Upper 4 bits of V Size
0x57	0x00	0	H Border	0 lines
0x58	0x00	0	V Border	0 pixels
0x59	0x18	24	Flags	Non-interlaced, normal display no stereo, digital separate, V. and H. sync polarity is negative
NOTE—Some addresses above contain 'composite' bytes representing high and/or low order bits or "nibbles" (4 bits of an 8-bit byte). Please refer to section 3.10.2 of the VESA E-EDID standard for details on these fields.				

**Table 70 Second Detailed Timing Descriptor Block (720x480p, 4:3 Example)**

### A.2.10.3 First Monitor Descriptor (Monitor Name)

The VESA Standard [10] requires that one of the four 18-byte descriptors be a Monitor Name Descriptor. Here, it is recommended that the third 18-byte descriptor be used as the First Monitor Descriptor or Monitor Name. Examples of these bytes are located at addresses 0x5F through 0x6B. Each location is one byte in length and is used for ASCII character string. In the example contained in Table 71, a fictitious Monitor Name is listed.

Address Hex	Example Data Hex	Example Data Dec	Description	Remarks
0x5A	0x00	0	Flag (REQUIRED)	Flag = 0x0000 when block used as descriptor
0x5B	0x00	0		
0x5C	0x00	0		
0x5D	0xFC	252	Data Type Tag	0xFC denotes that last 13 bytes of this descriptor block contain Monitor name
0x5E	0x00	0	Flag	Flag = 0x00 when block used as descriptor
0x5F	0x4D	77	ASCII coded monitor name (13 bytes max).  If name < 13 bytes, terminate name with 0x0A and fill remainder of 13 bytes with 0x20.	Example monitor name:  "MY HDTV"
0x60	0x59	89		
0x61	0x20	32		
0x62	0x48	72		
0x63	0x44	68		
0x64	0x54	84		
0x65	0x56	86		
0x66	0x0A	10		
0x67	0x20	32		
0x68	0x20	32		
0x69	0x20	32		
0x6A	0x20	32		
0x6B	0x20	32		

**Table 71 First Monitor Descriptor Block (Monitor Name)**

#### A.2.10.4 Second Monitor Descriptor (Monitor Range Limits)

The next and last 18-byte descriptor within Block 0 should be used as the Second Monitor Descriptor. In this example, it is the Monitor Range Limit, which is used to designate minimum and maximum parameters for horizontal and vertical frequencies and maximum pixel clock rate. In the following example, the block of data ranges from 0x6C through 0x7D. The data format is binary coded integer.

The first three locations, 0x6C (Flag), 0x6D (Flag), and 0x6E (Reserved Flag) are set to zero. Address 0x6F, a Data Type Flag, should be set to 0xFD, which means, "monitor range limits, binary coded." For more detail, please refer to the VESA E-EDID standard section 3.10.3 [10]. Address 0x70 is another flag and loaded with zero.

Locations 0x71 through 0x75 are used to designate the minimum and maximum parameters for horizontal and vertical frequencies, and maximum pixel clock. Table 72 contains an example for a DTV that supports a 60 Hz vertical refresh rate, 15 kHz up to 46 kHz horizontal rates, which cover the frequencies required for 720x480i and 1280x720p formats, including 480x720p and 1920x1080i, and a maximum pixel clock of 80 MHz.

For EDID (Version 1, Revision 3), inclusion of the Monitor Range Limits in base EDID (Block 0) does not imply that the sink is multi-scan capable

**NOTE**—To reduce the possibility that a source would mistakenly ignore the frequency range data if the minimum and maximum values were equal, a range of horizontal and vertical frequencies should be declared. For example, if a device supports only 15.75 kHz and 60 Hz timing, it is recommended to list the range as 15 to 16 kHz and 59 to 61 Hz. Sources may encounter legacy devices that specify the same value for MIN and MAX horizontal and/or vertical ranges.

Address Hex	Example Data Hex	Dec	Description	Remarks
0x6C	0x00	0	Flag	Flag = 0x0000 when block used as descriptor
0x6D	0x00	0		
0x6E	0x00	0		
0x6F	0xFD	253	Data Type Tag	FDh denotes that last 13 bytes of this descriptor block contain Monitor Range limits, binary coded
0x70	0x00	0	Flag	Flag = 0x00 when block used as descriptor
0x71	0x3B	59	Min Vertical Rate in Hz	59 HZ
0x72	0x3D	61	Max Vertical Rate in Hz	61 Hz
0x73	0x0F	15	Min Horizontal Rate in kHz	15 kHz
0x74	0x2E	46	Max Horizontal Rate in kHz	46 kHz
0x75	0x08	8	Max Supported pixel clock rate in MHz/10	80 MHz
0x76	0x00	0	Tag for secondary timing formula (0x00=not used)	No secondary timing formula supported
0x77	0x0A	10	Put 0x0A after last data byte in block and fill remaining bytes with 0x20.	Unused data address
0x78	0x20	32		
0x79	0x20	32		
0x7A	0x20	32		
0x7B	0x20	32		
0x7C	0x20	32		
0x7D	0x20	32		

**Table 72 Second Monitor Descriptor Block (Monitor Range Limits)**

Address 0x76 is used as a tag for a secondary generalized timing formula (GTF) and is not typically used for CE devices. In this case, the flag is set to zero. Addresses 0x77 through 0x7D are related to this tag. The E-EDID standard requires that address 0x77 contain 0x0A and addresses 0x78 ~ 0x7D contain 0x20 when no secondary GTF data is provided.

#### A.2.11 Extension Flag and Checksum

The Extension Flag and Checksum are defined as two-byte data located in address range 0x7E through 0x7F. The Extension Flag is used to indicate that additional blocks are present in the EDID that declare additional video formats and other monitor features.

The Extension Flag is used to declare the number of extensions that exist within the EDID tables. The total number of extensions actually present should equal the number of extensions declared within the base EDID. The number of extensions declared in the base EDID shall not include the base EDID, but shall include the block map. For example, if no extensions exist in the EDID data, then the Extension Flag shall be set to zero. If a single (e.g. CEA) extension is present, then the flag shall be set to one. If two (e.g. CEA) extensions are used, then a block map extension is also required by VESA EDID standard—increasing the total number of extensions to three. In this case, the extension flag is set to 3 and the sink has an EDID containing a total of four 128-byte blocks: a base block plus three extensions—the first extension being a block map.

**NOTE**—Some devices have been incorrectly designed so that the block map is not counted in the extension count. Design of compliant devices should take compatibility with those non-compliant devices into consideration. For example, when a source finds an extension count of 2, it may attempt to read 3 extensions on the chance that the sink has incorrectly set its count, or it may use the information in the block map as a more accurate guide.

The Checksum is set so that the sum of the entire 128-byte block modulus 256 equals 0x00. Sink designers should calculate checksum using the following formula:



$$\text{Checksum byte} = (256 - (S \% 256)) \% 256$$

Where:

S is the sum of the first 127 bytes  
% is modulus operator

Table 73 contains example data based upon the tables presented in this document. The Extension Flag at location 0x7E is set to one declaring that Block 1 is present. Since the Extension Flag equals 1 in the example, no other blocks exist. The Checksum is set so that the sum modulus 256 of the entire 128-byte block equals 0x00.

Address Hex	Example Data		Description	Remarks
	Hex	Dec		
0x7E	0x01	1	Extension Flag	Number of 128 bytes blocks to follow
0x7F	0xC3	195	Checksum	Block 0 sum (address 0x00~0x7E) = 0x1B3D

**Table 73 Extension Flag Block**

#### A.2.11.1 Block One Details

Although there may be DTV implementations that do not include a CEA Extension or that include it in a block other than Block 1, it is recommended that for a CEA-861-E implementation, that the CEA Extension be included in Block 1. Therefore, the remainder of Annex A (through Section A.4) assumes that Block 1 is a CEA Extension.

The main purpose of the CEA Extension is to provide a place to add additional Detailed Timing Descriptors. However, other VESA-defined 18-byte descriptors are possible (e.g., Monitor Serial Number, Manufacturer Specific, etc.). Sources should ignore descriptors that they do not understand. The only descriptors that a CEA-861-E source is required to understand are the Detailed Timing Descriptors, the Monitor Range Limit descriptor, and the Monitor Name Descriptor. Note that the handling of unused descriptors is different in the CEA Extension than it is in Block 0. In Block 0, all four descriptor blocks are required by VESA EDID standard [10] to be filled with valid data, even if it means repeating a timing descriptor. In the CEA Extension, unused descriptor locations are all collected at the end and filled with a fill pattern of 0x00. Technically, a descriptor that has the first bytes being 0x00 would be a manufacturer-defined descriptor with a tag of 0x00. It is recommended that manufacturers avoid the use of a 0x00 tag. Sources should verify that there are eighteen 0x00 bytes following the last valid descriptor if there is enough room for a descriptor. It is also recommended that the DTV place all of its remaining Detailed Timing Descriptors before other descriptors in the CEA Extension.

Within the CEA Extension, per CEA-861-E, up to six Detailed Timing Descriptors are allowed and may occur in any order. Therefore, sources should be able to handle any combination or sequence that these Detailed Timing Descriptors may appear. According to CEA-861-E, the timing of highest priority is listed first and subordinate timings in descending order. Sources should be capable of skipping additional extensions that they may not understand when encountered within Block 1.

#### A.2.12 Overview of Extensions

VESA has assigned Extension Tags to identify EDID extensions and sources should anticipate encountering some of these extensions. Extensions are identified by the first byte (i.e., Tags). The Tags indicate the type of extension and its purpose. CEA-861 implementations are required to use Tag = 0x02 for the CEA Extension Tag and sources should ignore Tags that are not understood.

In the subsequent sections of this Annex (excepting Section A.2.19), an example is given utilizing CEA extension block version 1. Version 3 of the CEA extension is most common and is required for HDMI implementations. For HDMI implementations, extension block version 3 is required. An example of version 3 is given in Annex D.6. See Section 7.1 for additional guidance on the use of specific versions.

### A.2.13 Block One CEA Extension Header

The CEA Extension Header is defined as four-byte data located in the first four bytes of the EDID block. The first byte is the tag used to identify the extension. The number assigned by VESA to this tag is 0x02. Following the CEA Extension Tag is the Revision Number location. The data for Revision Number was set according to which standard version the sink was designed to support. CEA-861, CEA-861-A, and CEA-861-B all had unique number assignments for the Revision Number and this was used to differentiate the level of supported features, such as "InfoPackets", audio, etc. Incrementing the version number is no longer required. The revision number shall be set to 0x03.

Note that CEA-861 and CEA-861-A required the revision number to be set to 0x01 and 0x02, respectively. See Section 7.1 for further guidance. Versions 2 and 3 of the CEA Extension are backward compatible with version 1, which is illustrated in this example.

Sources should be prepared to read versions later than version 1 and properly interpret the required 18-byte descriptors.

Following the Revision Number is the Byte Number Offset. This is used to tell where the Detailed Timing Data begins following the Reserved Data Block. The source should use this byte offset to skip fields that it may not understand within the CEA Extension when encountering versions of this extension that may be newer than its own. CEA-861 sinks should load location 82 with  $d = 4$  if the extension includes 18-byte descriptors. In the following example, the data is listed as 0x04, which means there is no data present in the Reserved Data Block and that there are 18-byte descriptors present starting at the fifth byte of the EDID block.

Sources should be aware that for later versions of the CEA Extension,  $d$  may be set to something other than 0 when no 18-byte descriptors are present. This is an indication that there is data in the reserved data block. In such a case,  $d$  would be set to the location where 18-byte detailed timing descriptors would be located if present. That data should be skipped by a CEA-861-E source. The presence of padding data for 18-byte descriptors can be used by the source as an indication whether 18-byte descriptors are present or not.

The data at the next address location, 0x83 in this example, is reserved in the CEA Extension Version 1 (used for an 861 implementation) and is required in 861 to be set to 0x00. Newer versions of the CEA Extension include flags in this field (see Sections 7.3 and 7.4). These flags can be ignored by a CEA-861-E source.

Table 74 contains example data based upon the tables presented in this document. In this example, the CEA Extension Tag is located at 0x80 followed by Revision Number, Byte Number Offset, and Reserved (i.e., 0x00). The data is set as prescribed by CEA-861-E.

Address Hex	Example Data		Description	Remarks
	Hex	Dec		
0x80	0x02	2	Tag per CEA-861	Tag 0x02 assigned by VESA to CEA for this extension
0x81	0x01	1	0x01 per CEA-861	Indicates revision of CEA-861 used by this device
0x82	0x04	4	0x04 per CEA-861	0x04 indicates no data present in Reserved Data Block; 18-byte descriptors ARE present
0x83	0x00	0	0x00 per CEA-861	These bits are utilized as flags in later versions of CEA-861

**Table 74 Block One CEA Extension Header**

### A.2.14 Third Detailed Timing Descriptor

Following the Extension Flag Table is the next or Third Detailed Timing Descriptor. Table 75 follows the same format as with Table 69 and Table 70. This example is for HD format 1280x720p.

Address Hex	Example Data		Description	Remarks (Refer to note below for additional details)
	Hex	Dec		
0x84	0x01	1	Pixel Clock	74.25 MHz
0x85	0x1D	29		
0x86	0x00	0	H Active	1280 pixels
0x87	0x72	114	H Blanking	370 pixels
0x88	0x51	81	H Active: H Blanking	
0x89	0xD0	208	V Active	720 lines
0x8A	0x1E	30	V Blanking	30 lines
0x8B	0x20	32	V Active: V Blanking	
0x8C	0x6E	110	H Sync Offset	110 pixels
0x8D	0x28	40	H Sync Pulse Width	40 pixels
0x8E	0x55	85	VS Offset: VS Pulse Width	
0x8F	0x00	0	HS Offset: HS Pulse Width: VS Offset: VS Pulse Width	
0x90	0x20	32	H Image Size	800 mm (lower 8 bits)
0x91	0xC2	194	V Image Size	450 mm (lower 8 bits)
0x92	0x31	49	H&V Image Size	Upper 4 bits of H Size; Upper 4 bits of V Size
0x93	0x00	0	H Border	0 pixels
0x94	0x00	0	V Border	0 lines
0x95	0x1E	30	Flags	Non-interlaced, normal display no stereo, digital separate, H and V sync polarity is positive
NOTE—Some addresses above contain 'composite' bytes representing high and/or low order bits or "nibbles" (4 bits of an 8-bit byte). Please refer to section 3.10.2 of the VESA E-EDID standard for details on these fields.				

**Table 75 Third Detailed Timing Descriptor Block (720p, 16:9 Example)**

### A.2.15 Fourth Detailed Timing Descriptor

After the Third Detailed Timing Descriptor, the next Detailed Timing Descriptor follows, as indicated in Table 76. As with Table 69, Table 70 and Table 75, the same format is used. This table declares the SD 720x480i format, which requires doubling the horizontal pixel count to meet the DVI 1.0 minimum pixel clock frequency.

Address Hex	Example Data		Description	Remarks (Refer to note below for additional details)
	Hex	Dec		
0x96	0x8C	140	Pixel Clock	27 MHz
0x97	0x0A	10		
0x98	0xA0	160	H Active	1440 pixels
0x99	0x14	20	H Blanking	276 pixels
0x9A	0x51	81	H Active: H Blanking	
0x9B	0xF0	240	V Active	240 lines
0x9C	0x16	22	V Blanking	22 lines
0x9D	0x00	0	V Active: V Blanking	
0x9E	0x26	38	H Sync Offset	38 pixels
0x9F	0x7C	124	H Sync Pulse Width	124 pixels
0xA0	0x43	67	VS Offset: VS Pulse Width	
0xA1	0x00	0	HS Offset: HS Pulse Width: VS Offset: VS Pulse Width	
0xA2	0x58	88	H Image Size	600 mm (lower 8 bits)
0xA3	0xC2	194	V Image Size	450 mm (lower 8 bits)
0xA4	0x21	33	H&V Image Size	Upper 4 bits of H Size; Upper 4 bits of V Size
0xA5	0x00	0	H Border	0 lines
0xA6	0x00	0	V Border	0 pixels
0xA7	0x98	152	Flags	Interlaced, normal display no stereo, digital separate, V. and H. sync polarity is negative,
NOTE—Some addresses above contain 'composite' bytes representing high and/or low order bits or "nibbles" (4 bits of an 8-bit byte). Please refer to section 3.10.2 of the VESA E-EDID standard for details on these fields.				

**Table 76 Fourth Detailed Timing Descriptor Block (480i, 4:3 Example)**

#### A.2.16 Descriptor Defined by Manufacturer

The Descriptor Defined by Manufacturer Table is placed after the last Detailed Timing Descriptor. The manufacturer defines the contents of this descriptor. The tag can be any value between 0x00 and 0x0F although the use of 0x00 is not recommended as explained in section 4.3. The example in Table 77 illustrates data that declares a revision number.

Address Hex	Example Data		Description	Remarks
	Hex	Dec		
0xA8	0x00	0	Flag	
0xA9	0x00	0	Flag	
0xAA	0x00	0	Reserved	
0xAB	0x01	1	Data Type 01-0F	
0xAC	0x00	0	Flag	
0xAD	0x52	82	R	
0xAE	0x45	69	E	
0xAF	0x56	86	V	
0xB0	0x31	49	1	
0xB1	0x2E	46	.	
0xB2	0x30	48	0	
0xB3	0x30	48	0	
0xB4	0x0A	10		
0xB5	0x00	0		
0xB6	0x00	0		
0xB7	0x00	0		
0xB8	0x00	0		
0xB9	0x00	0		

**Table 77 Descriptor Defined by Manufacturer Block**

#### A.2.17 Monitor Serial Number

13 bytes of this 18-byte table are allocated for the Monitor Serial number. This table can be used for the manufacturer's convenience. The monitor serial number descriptor uses 0xFF as the tag. Tags are described in Section 4.2.8. The data should be ASCII based. Table 78 contains a fictitious serial number as an example.

Address Hex	Example Data		Description	Remarks
	Hex	Dec		
0xBA	0x00	0	Flag	Flag = 0x0000 when block used as descriptor
0xBB	0x00	0		
0xBC	0x00	0	Flag (Reserved)	Flag = 0x00 when block used as descriptor
0xBD	0xFF	255	Serial Number Tag	Refer to VESA E-EDID standard, section 3.10.3 for tag definitions
0xBE	0x00	0	Flag	
0xBF	0x39	57	ASCII serial number data	'9'
0xC0	0x39	57		'9'
0xC1	0x46	70		'F'
0xC2	0x43	67		'C'
0xC3	0x35	53		'5'
0xC4	0x30	48		'0'
0xC5	0x30	48		'0'
0xC6	0x30	48		'0'
0xC7	0x31	49		'1'
0xC8	0x0A	10		ASCII Line Feed
0xC9	0x20	32		Padding (ASCII space)
0xCA	0x20	32		Padding (ASCII space)
0xCB	0x20	32		Padding (ASCII space)

**Table 78 Monitor Serial Number Block**

#### A.2.18 Residual Byte Padding and Check Sum

CEA-861-E requires that residual addresses contain padding. In this case, 0x00 is used as padding. Address 0xFF should contain a one-byte checksum value such that when all bytes of the entire 128-byte block are added, the sum modulus 256 equals 0x00. Table 79 illustrates these requirements.

Address Hex	Example Data Hex Dec		Description	Remarks
0xCC	0x00	0	1 <sup>st</sup> padding byte	Padding bytes should = 0x00.
0xCD	0x00	0	Additional padding bytes	
0xCE	0x00	0		
0xCF	0x00	0		
0xD0	0x00	0		
0xD1	0x00	0		
0xD2	0x00	0		
0xD3	0x00	0		
0xD4	0x00	0		
0xD5	0x00	0		
0xD6	0x00	0		
0xD7	0x00	0		
0xD8	0x00	0		
0xD9	0x00	0		
0xDA	0x00	0		
0xDB	0x00	0		
0xDC	0x00	0		
0xDD	0x00	0		
0xDE	0x00	0		
0xDF	0x00	0		
0xE0	0x00	0		
0xE1	0x00	0		
0xE2	0x00	0		
0xE3	0x00	0		
0xE4	0x00	0		
0xE5	0x00	0		
0xE6	0x00	0		
0xE7	0x00	0		
0xE8	0x00	0		
0xE9	0x00	0		
0xEA	0x00	0		
0xEB	0x00	0		
0xEC	0x00	0		
0xED	0x00	0		
0xEE	0x00	0		
0xEF	0x00	0		
0xF0	0x00	0		
0xF1	0x00	0		
0xF2	0x00	0		
0xF3	0x00	0		
0xF4	0x00	0		
0xF5	0x00	0		
0xF6	0x00	0		
0xF7	0x00	0		
0xF8	0x00	0		
0xF9	0x00	0		
0xFA	0x00	0		
0xFB	0x00	0		
0xFC	0x00	0		
0xFD	0x00	0		
0xFE	0x00	0	Last padding byte	
0xFF	0x84	132	Checksum	Block 1 sum (address 0x80~0xFF) = 0x0E7C

Table 79 Residual Byte Stuffing and Check Sum Block

### A.2.19 Hot Plugging Sequence

An important element to proper interpretation of EDID is “Hot Plugging”. The following presents a recommendation for achieving consistent results during a Hot Plugging event.

DVI 1.0 defines a Hot Plug Detect (HPD) signal function that indicates to the source whether a display is connected. HPD is designed to be powered by the DDC + 5V coming from the source, and to be independent of whether the monitor is powered or not. In this way, a source can detect the monitor and read its characteristics from EDID without the monitor being powered. On a PC, this feature allows the system to load the correct display configuration without delaying the boot process.

In short, in this context, HPD serves as an indication that the EDID is available to be read, however HPD may also have alternative uses. It does not imply any other state of readiness. The relevant definitions from the DVI 1.0 specification are:

- a) Section 2.6: Hot Plug Detect (HPD) – Signal is driven by monitor to enable the system to identify the presence of a monitor.
- b) Section 2.2.9.2: The monitor is required to provide a voltage of greater than +2.4V on the Hot Plug Detect (HPD) pin of the connector only when the EDID data structure is available to be read by the source.

Implementation Note: As an example for hot plug support, a simple monitor implementation of HPD support could be a pull up resistor to the EDID power supply. After HPD goes active, the source is only expected to read EDID and determine that a valid display mode is available and supported.

NOTE—Whenever the EDID information in a device changes for any reason (e.g. if the EDID was updated, or is capable of dynamically changing its information content), the receiving device pulses HPD low for at least 100ms. This recommendation follows from the HDCP repeater implementation requirement that HDCP repeaters pulse HPD low for at least 100ms to indicate the connection of a new device or disconnection of an existing one.

## A.3 Complete Example EDID Table (Informative)

Address Hex	Example Data Hex Dec		Name of Block	Description	Remarks
0x00	0x00	0	Block Zero Header		Fixed Value
0x01	0xFF	255			
0x02	0xFF	255			
0x03	0xFF	255			
0x04	0xFF	255			
0x05	0xFF	255			
0x06	0xFF	255			
0x07	0x00	0			
0x08	0x0C	12	Vendor / Product ID	Manufacturer Name	CEA
0x09	0xA1	161		Product Code	Used to differentiate between different models from the same manufacturer.
0x0A	0x00	00			
0x0B	0x00	0		Serial Number	Optional. The serial number can also be stored in a separate descriptor block
0x0C	0x00	00			
0x0D	0x00	00			
0x0E	0x00	00			
0x0F	0x00	00			
0x10	0x00	0			
0x11	0x0C	12		Year of Manufacture	Year 2002
0x12	0x01	1	EDID Structure Version / Revision	Version #	1
0x13	0x03	3		Revision #	3
0x14	0x80	128	Basic Display Parameters / Features	Video Input Definition	Digital, VESA DFP1X : not compatible
0x15	0x50	80		Max. Horizontal Image Size in cm	Optional. The system should not make any assumption regarding display size
0x16	0x2D	45		Max. Vertical Image Size in cm	Optional. See above.
0x17	0x78	120		Gamma: (gamma x 100)-100 = value	Example is: (gamma = 2.2) (2.2 x 100)-100 = 120
0x18	0x0A	10		Feature Support	0x0A denotes: RGB color Display type, preferred timing: first detailed timing block. GTF timing: not supported. Standby mode: not supported, suspend mode: not supported, active off: not supported

Table 80 Complete EDID Example



Address Hex	Example Data Hex	Dec	Name of Block	Description	Remarks
0x19	0x0D	13	Color Characteristics	Red/Green Low Bits	
0x1A	0xC9	201		Blue/White Low Bits	
0x1B	0xA0	160		Red-x	0.625
0x1C	0x57	87		Red-y	0.340
0x1D	0x47	71		Green-x	0.280
0x1E	0x98	152		Green-y	0.595
0x1F	0x27	39		Blue-x	0.155
0x20	0x12	18		Blue-y	0.070
0x21	0x48	72		White-x	0.283
0x22	0x4C	76		White-y	0.298
0x23	0x20	32	Established Timings	Timing 1	640x480 @60Hz
0x24	0x00	0		Timing 2	None
0x25	0x00	0		Manufacturer's Reserved Timing	None
0x26	0x01	1	Standard Timing ID # 1-8	Standard Timing ID #1	PC Applications
0x27	0x01	1		Standard Timing ID #2	PC Applications
0x28	0x01	1		Standard Timing ID #3	PC Applications
0x29	0x01	1		Standard Timing ID #4	PC Applications
0x2A	0x01	1		Standard Timing ID #5	PC Applications
0x2B	0x01	1		Standard Timing ID #6	PC Applications
0x2C	0x01	1		Standard Timing ID #7	PC Applications
0x2D	0x01	1		Standard Timing ID #8	PC Applications
0x2E	0x01	1			
0x2F	0x01	1			
0x30	0x01	1			
0x31	0x01	1			
0x32	0x01	1			
0x33	0x01	1			
0x34	0x01	1			
0x35	0x01	1			
0x36	0x01	1	First Detailed Timing Descriptor (Preferred)	Pixel Clock	74.25 MHz
0x37	0x1D	29		H Active	1920 pixels
0x38	0x80	128		H Blanking	280 pixels
0x39	0x18	24		H Active: H Blanking	
0x3A	0x71	113		V Active	540 lines
0x3B	0x1C	28		V Blanking	22 lines
0x3C	0x16	22		V Active: V Blanking	
0x3D	0x20	32		H Sync Offset	88 pixels
0x3E	0x58	88		H Sync Pulse Width	44 pixels
0x3F	0x2C	44		VS Offset: VS Pulse Width	2 lines, 5 lines
0x40	0x25	37		HS Offset: HS Pulse Width: VS Offset: VS Pulse Width	
0x41	0x00	0		H Image Size	800 mm
0x42	0x20	32		V Image Size	450 mm
0x43	0xC2	194		H&V Image Size	
0x44	0x31	49	H Border	0 lines	
0x45	0x00	0	V Border	0 pixels	
0x46	0x00	0	Flags	Interlaced, normal display no stereo, digital separate, Vsync polarity is positive, Hsync polarity is positive	
0x47	0x9E	158			

Table 80 Complete EDID Example (Continued)

Address Hex	Example Data Hex	Dec	Name of Block	Description	Remarks	
0x48	0x8C	140	Second Detailed Timing Descriptor	Pixel Clock	27 MHz	
0x49	0x0A	10				
0x4A	0xD0	208		H Active	720 pixels	
0x4B	0x8A	138		H Blanking	138 pixels	
0x4C	0x20	32		H Active: H Blanking		
0x4D	0xE0	224		V Active	480 lines	
0x4E	0x2D	45		V Blanking	45 lines	
0x4F	0x10	16		V Active: V Blanking		
0x50	0x10	16		H Sync Offset	16 pixels	
0x51	0x3E	62		H Sync Pulse Width	62 pixels	
0x52	0x96	150		VS Offset: VS Pulse Width	9 lines, 6 lines	
0x53	0x00	0		HS Offset: HS Pulse Width: VS Offset: VS Pulse Width		
0x54	0x58	88		H Image Size	600 mm	
0x55	0xC2	194		V Image Size	450 mm	
0x56	0x21	33		H&V Image Size		
0x57	0x00	0		H Border	0 lines	
0x58	0x00	0		V Border	0 pixels	
0x59	0x18	24		Flags	non interlaced, normal display no stereo, digital separate, V. and H. sync polarity is negative	
0x5A	0x00	0		Monitor Descriptor Currently Mandatory (Monitor Name)	Flag	
0x5B	0x00	0			Flag (Reserved)	
0x5C	0x00	0	Data Type Tag		Monitor name type	
0x5D	0xFC	252	Flag			
0x5E	0x00	0	M			
0x5F	0x4D	77	Y			
0x60	0x59	89				
0x61	0x20	32	H			
0x62	0x48	72	D			
0x63	0x44	68	T			
0x64	0x54	84	V			
0x65	0x56	86				
0x66	0x0A	10				
0x67	0x20	32				
0x68	0x20	32				
0x69	0x20	32				
0x6A	0x20	32				
0x6B	0x20	32				

Table 80 Complete EDID Example (Continued)

Address Hex	Example Data Hex	Dec	Name of Block	Description	Remarks	
0x6C	0x00	0	Second Monitor Descriptor Currently Mandatory (range limits, binary coded)	Flag		
0x6D	0x00	0		Flag (Reserved)		
0x6E	0x00	0		Data Type Tag	Monitor Range limits, binary coded, mandatory block	
0x6F	0xFD	253		Flag		
0x70	0x00	0		Min Vertical Rate in Hz	59 HZ	
0x71	0x3B	59		Max Vertical Rate in Hz	61 Hz	
0x72	0x3D	61		Min Horizontal Rate in kHz	15 kHz	
0x73	0x0F	15		Max Horizontal Rate in kHz	46 kHz	
0x74	0x2E	46		Max Supported pixel clock rate in MHz/10	80 MHz	
0x75	0x08	8		Tag for secondary timing formula (0x00=not used)	No secondary timing formula supported	
0x76	0x00	0		Fixed		
0x77	0x0A	10		Fixed		
0x78	0x20	32		Fixed		
0x79	0x20	32		Fixed		
0x7A	0x20	32		Fixed		
0x7B	0x20	32		Fixed		
0x7C	0x20	32		Fixed		
0x7D	0x20	32		Fixed		
0x7E	0x01	1		Extension Flag	Number of 128 bytes blocks to follow	
0x7F	0xC3	195		Checksum	Block 0 sum = 0x1B3D	
0x80	0x02	2	CEA Extension Header	Tag	Block One	
0x81	0x01	1	0x01 by 861	Revision Number		
0x82	0x04	4	0x04, no data in Reserved	Byte Offset		
0x83	0x00	0	0x00 by 861			

Table 80 Complete EDID Example (Continued)

Address Hex	Example Data Hex	Dec	Name of Block	Description	Remarks	
0x84	0x01	1	Third Detailed Timing Descriptor	Pixel Clock	74.25 MHz	
0x85	0x1D	29		H Active	1280 pixels	
0x86	0x00	0		H Blanking	370 pixels	
0x87	0x72	114		H Active: H Blanking		
0x88	0x51	81		V Active	720 lines	
0x89	0xD0	208		V Blanking	30 lines	
0x8A	0x1E	30		V Active: V Blanking		
0x8B	0x20	32		H Sync Offset	110 pixels	
0x8C	0x6E	110		H Sync Pulse Width	40 pixels	
0x8D	0x28	40		VS Offset: VS Pulse Width		
0x8E	0x55	85		HS Offset: HS Pulse Width: VS Offset: VS Pulse Width		
0x8F	0x00	0		H Image Size	800 mm	
0x90	0x20	32		V Image Size	450 mm	
0x91	0xC2	194		H&V Image Size		
0x92	0x31	49		H Border	0 pixels	
0x93	0x00	0		V Border	0 lines	
0x94	0x00	0		Flags	Non-interlaced, normal display no stereo, digital separate, H and V sync polarity is positive	
0x95	0x1E	30				
0x96	0x8C	140		Fourth Detailed Timing Descriptor	Pixel Clock	27 MHz
0x97	0x0A	10			H Active	1440 pixels
0x98	0xA0	160	H Blanking		276 pixels	
0x99	0x14	20	H Active: H Blanking			
0x9A	0x51	81	V Active		240 lines	
0x9B	0xF0	240	V Blanking		22 lines	
0x9C	0x16	22	V Active: V Blanking			
0x9D	0x00	0	H Sync Offset		38 pixels	
0x9E	0x26	38	H Sync Pulse Width		124 pixels	
0x9F	0x7C	124	VS Offset: VS Pulse Width			
0xA0	0x43	67	HS Offset: HS Pulse Width: VS Offset: VS Pulse Width			
0xA1	0x00	0	H Image Size		600 mm	
0xA2	0x58	88	V Image Size		450 mm	
0xA3	0xC2	194	H&V Image Size			
0xA4	0x21	33	H Border		0 lines	
0xA5	0x00	0	V Border		0 pixels	
0xA6	0x00	0	Flags	interlaced, normal display no stereo, digital separate, V. and H. sync polarity is negative,		
0xA7	0x98	152				

Table 80 Complete EDID Example (Continued)

Address Hex	Example Data Hex	Dec	Name of Block	Description	Remarks	
0xA8	0x00	0	Descriptor Defined by Manufacturer	Flag		
0xA9	0x00	0		Flag		
0xAA	0x00	0		Reserved		
0xAB	0x01	1		Data Type 0x01-0x0F		
0xAC	0x00	0		Flag		
0xAD	0x52	82		'R'		
0xAE	0x45	69		'E'		
0xAF	0x56	86		'V'		
0xB0	0x31	49		'1'		
0xB1	0x2E	46		'.'		
0xB2	0x30	48		'0'		
0xB3	0x30	48		'0'		
0xB4	0x0A	10				
0xB5	0x00	0				
0xB6	0x00	0				
0xB7	0x00	0				
0xB8	0x00	0				
0xB9	0x00	0				
0xBA	0x00	0		Monitor Serial Number (ASCII, 13 bytes max)		
0xBB	0x00	0				
0xBC	0x00	0				
0xBD	0xFF	255	Serial Number Tag			
0xBE	0x00	0				
0xBF	0x39	57	'9'			
0xC0	0x39	57	'9'			
0xC1	0x46	70	'F'			
0xC2	0x43	67	'C'			
0xC3	0x35	53	'5'			
0xC4	0x30	48	'0'			
0xC5	0x30	48	'0'			
0xC6	0x30	48	'0'			
0xC7	0x31	49	'1'			
0xC8	0x0A	10				
0xC9	0x20	32				
0xCA	0x20	32				
0xCB	0x20	32				

Table 80 Complete EDID Example (Continued)

Address Hex	Example Data Hex	Dec	Name of Block	Description	Remarks
0xCC	0x00	0	Residual Byte Padding		
0xCD	0x00	0			
0xCE	0x00	0			
0xCF	0x00	0			
0xD0	0x00	0			
0xD1	0x00	0			
0xD2	0x00	0			
0xD3	0x00	0			
0xD4	0x00	0			
0xD5	0x00	0			
0xD6	0x00	0			
0xD7	0x00	0			
0xD8	0x00	0			
0xD9	0x00	0			
0xDA	0x00	0			
0xDB	0x00	0			
0xDC	0x00	0			
0xDD	0x00	0			
0xDE	0x00	0			
0xDF	0x00	0			
0xE0	0x00	0			
0xE1	0x00	0			
0xE2	0x00	0			
0xE3	0x00	0			
0xE4	0x00	0			
0xE5	0x00	0			
0xE6	0x00	0			
0xE7	0x00	0			
0xE8	0x00	0			
0xE9	0x00	0			
0xEA	0x00	0			
0xEB	0x00	0			
0xEC	0x00	0			
0xED	0x00	0			
0xEE	0x00	0			
0xEF	0x00	0			
0xF0	0x00	0			
0xF1	0x00	0			
0xF2	0x00	0			
0xF3	0x00	0			
0xF4	0x00	0			
0xF5	0x00	0			
0xF6	0x00	0			
0xF7	0x00	0			
0xF8	0x00	0			
0xF9	0x00	0			
0xFA	0x00	0			
0xFB	0x00	0			
0xFC	0x00	0			
0xFD	0x00	0			
0xFE	0x00	0			
0xFF	0x84	132	Checksum		Block 1 sum = 0x0E7C

**Table 80 Complete EDID Example (Continued)**

#### A.4 Example EDID Detailed Timing Descriptors

Byte# (HEX)	Function	Value (HEX)	Value (binary)	Notes
0x36	Pixel Clock/10,000 (LSB stored first)	0x01		Pixel Clock = 74.25 MHz
0x37		0x1D		
0x38	Horizontal Active Pixels (lower 8 bits)	0x00		hor. active pixels = 1280 = 0x500
0x39	Horizontal Blanking Pixels (lower 8 bits)	0x72		hor. blanking pixels = 370 = 0x172
0x3A	Horizontal Active and Blanking Pixels (upper nibble = upper 4 bits of active) (lower nibble = upper 4 bits of blanking)	0x51		
0x3B	Vertical Active Lines, lower 8 bits	0xD0		vert. active lines = 720 = 0x2D0
0x3C	Vertical Blanking Lines, lower 8 bits	0x1E		vert. blanking lines = 30 = 0x1E
0x3D	Vertical Active: Vertical Blanking (upper nibble = upper 4 bits of active) (lower nibble = upper 4 bits of blanking)	0x20		
0x3E	Horizontal sync. offset (pixels) (from blanking starts, lower 8 bits)	0x6E		offset = 110 pixels = 0x6E
0x3F	Horizontal sync pulse width (pixels) (lower 8 bits)	0x28		width = 40 pixels = 0x28
0x40	Vert sync offset; Vert sync pulse width (upper nibble = lines, lower 4 bits of vertical sync offset) (lower nibble = lines, lower 4 bits of vertical sync pulse width)	0x55		vert sync. offset = 5 lines vert. sync width = 5 lines
0x41	bits 7,6: upper 2 bits of Hor. sync. offset bits 5,4: upper 2 bits of Hor. sync pulse width bits 3,2: upper 2 bits of vert sync offset bits 1,0: upper 2 bits of vert. sync pulse width	0x00	00000000	
0x42	Horizontal Image Size (mm, lower 8 bits)	0xC4		Hor. Image size = 708 mm = 0x2C4
0x43	Vertical Image Size (mm, lower 8 bits)	0x8E		Vert. Image Size = 398 mm = 0x18E
0x44	Horizontal and Vertical Image Size (upper nibble = upper 4 bits of horiz.) (lower nibble = upper 4 bits of vert.)	0x21		
0x45	Horizontal Border (pixels)	0x0		Shall be 0
0x46	Vertical Border (pixels)	0x0		Shall be 0
0x47	Flags (bit 7 = non-interlaced; bit 5,6 = normal display; bit 1, 2, 3,4 = sync description; bit 0 = do not care)	0x1E	00011110	Flag = non- interlaced; non-stereo; digital separate; positive V sync; positive H sync

**Table 81 Example EDID Detailed Timing Descriptor for 1280x720p (60 Hz, 16:9)**

Byte# (Hex)	Function	Value (Hex)	Value (binary)	Notes
0x36	Pixel Clock/10,000 (LSB stored first)	0x01		Pixel Clock = 74.25 MHz
0x37		0x1D		
0x38	Horizontal Active Pixels (lower 8 bits)	0x80		hor. active pixels = 1920 = 0x780
0x39	Horizontal Blanking Pixels (lower 8 bits)	0x18		hor. blanking pixels = 280 = 0x118
0x3A	Horizontal Active and Blanking Pixels (upper nibble = upper 4 bits of active) (lower nibble = upper 4 bits of blanking)	0x71		
0x3B	Vertical Active Lines, lower 8 bits	0x1C		vert. active lines = 540 = 0x21C
0x3C	Vertical Blanking Lines, lower 8 bits	0x16		vert. blanking lines = 22 = 0x16 <sup>9</sup>
0x3D	Vertical Active: Vertical Blanking (upper nibble = upper 4 bits of active) (lower nibble = upper 4 bits of blanking)	0x20		
0x3E	Horizontal sync. offset (pixels) (from blanking starts, lower 8 bits)	0x58		offset = 88 pixels = 0x58
0x3F	Horizontal sync pulse width (pixels) (lower 8 bits)	0x2C		width = 44 pixels = 0x2C
0x40	Vert. sync offset; Vert. sync pulse width (upper nibble = lines, lower 4 bits of vertical sync offset) (lower nibble = lines, lower 4 bits of vertical sync pulse width)	0x25		vert. sync offset = 2 lines <sup>10</sup> vert. sync width = 5 lines
0x41	bits 7,6: upper 2 bits of Hor. sync. offset bits 5,4: upper 2 bits of Hor. sync pulse width bits 3,2: upper 2 bits of vert sync offset bits 1,0: upper 2 bits of vert. sync pulse width	0x00	00000000	
0x42	Horizontal Image Size (mm, lower 8 bits)	0xC4		Hor. Image size = 708 mm = 0x2C4 <sup>11</sup>
0x43	Vertical Image Size (mm, lower 8 bits)	0x8E		Vert. Image Size = 398 mm = 0x18E
0x44	Horizontal and Vertical Image Size (upper nibble = upper 4 bits of horiz.) (lower nibble = upper 4 bits of vert.)	0x21		
0x45	Horizontal Border (pixels)	0x00		Shall be 0
0x46	Vertical Border (pixels)	0x00		Shall be 0
0x47	Flags (bit 7 = interlaced; bit 5,6 = normal display; bit 1, 2, 3,4 = sync description; bit 0 = do not care)	0x9E	10011110	Flag = interlaced; non-stereo; digital separate; positive V sync; positive H sync

**Table 82 Example EDID Detailed Timing Descriptor for 1920x1080i (60 Hz, 16:9)**

<sup>9</sup> For interlaced display: Field 1 vertical blanking = Vertical Blanking Lines. Field 2 vertical blanking = Vertical Blanking Lines + 1 blanking line.

<sup>10</sup> For interlaced display: Field 1 vertical offset = Vertical Sync Offset. Field 2 vertical offset = Vertical Sync Offset + 0.5 lines.

<sup>11</sup> Image size is display dependent. Ratio of Horizontal Image Size to Vertical Image Size shall be 16:9 or 4:3.



Byte# (HEX)	Function	Value (HEX)	Value (binary)	Notes
0x36	Pixel Clock/10,000 (LSB stored first)	0x8C		Pixel Clock = 27.00 MHz
0x37		0x0A		
0x38	Horizontal Active Pixels (lower 8 bits)	0xD0		hor. active pixels = 720 = 0x2D0
0x39	Horizontal Blanking Pixels (lower 8 bits)	0x8A		hor. blanking pixels = 138 = 0x8A
0x3A	Horizontal Active and Blanking Pixels (upper nibble = upper 4 bits of active) (lower nibble = upper 4 bits of blanking)	0x20		
0x3B	Vertical Active Lines, lower 8 bits	0xE0		vert. active lines = 480 = 0x1E0
0x3C	Vertical Blanking Lines, lower 8 bits	0x2D		vert. blanking lines = 45 = 0x2D
0x3D	Vertical Active: Vertical Blanking (upper nibble = upper 4 bits of active) (lower nibble = upper 4 bits of blanking)	0x10		
0x3E	Horizontal sync. offset (pixels) (from blanking starts, lower 8 bits)	0x10		offset = 16 pixels = 0x10
0x3F	Horizontal sync pulse width (pixels) (lower 8 bits)	0x3E		width = 62 pixels = 0x3E
0x40	Vert. sync offset; Vert. sync pulse width (upper nibble = lines, lower 4 bits of vertical sync offset) (lower nibble = lines, lower 4 bits of vertical sync pulse width)	0x96		vert. sync offset = 9 lines vert. sync width = 6 lines
0x41	bits 7,6: upper 2 bits of Hor. sync. offset bits 5,4: upper 2 bits of Hor. sync pulse width bits 3,2: upper 2 bits of vert sync offset bits 1,0: upper 2 bits of vert. sync pulse width	0x00	00000000	
0x42	Horizontal Image Size (mm, lower 8 bits)	0x13		Hor. Image size = 531 mm = 0x213
0x43	Vertical Image Size (mm, lower 8 bits)	0x8E		Vert. Image Size = 398 mm = 0x18E (4:3 in this case).
0x44	Horizontal and Vertical Image Size (upper nibble = upper 4 bits of horiz.) (lower nibble = upper 4 bits of vert.)	0x21		
0x45	Horizontal Border (pixels)	0x00		Shall be 0
0x46	Vertical Border (pixels)	0x00		Shall be 0
0x47	Flags (bit 7 = non-interlaced; bit 5,6 = normal display; bit 1, 2, 3,4 = sync description; bit 0 = do not care)	0x18	00011000	Flag = non-interlaced; non-stereo; digital separate; negative V sync; negative H sync

**Table 83 Example EDID Detailed Timing Descriptor for 720x480p (59.94 Hz, 4:3)**

Byte# (HEX)	Function	Value (HEX)	Value (binary)	Notes
0x36	Pixel Clock/10,000 (LSB stored first)	0x8C		Pixel Clock = 27.00 MHz
0x37		0x0A		
0x38	Horizontal Active Pixels (lower 8 bits)	0xD0		hor. active pixels = 720 = 0x2D0
0x39	Horizontal Blanking Pixels (lower 8 bits)	0x8A		hor. blanking pixels = 138 = 0x8A
0x3A	Horizontal Active and Blanking Pixels (upper nibble = upper 4 bits of active) (lower nibble = upper 4 bits of blanking)	0x20		
0x3B	Vertical Active Lines, lower 8 bits	0xE0		vert. active lines = 480 = 0x1E0
0x3C	Vertical Blanking Lines, lower 8 bits	0x2D		vert. blanking lines = 45 = 0x2D
0x3D	Vertical Active: Vertical Blanking (upper nibble = upper 4 bits of active) (lower nibble = upper 4 bits of blanking)	0x10		
0x3E	Horizontal sync. offset (pixels) (from blanking starts, lower 8 bits)	0x10		offset = 16 pixels = 0x10
0x3F	Horizontal sync pulse width (pixels) (lower 8 bits)	0x3E		width = 62 pixels = 0x3E
0x40	Vert sync offset; Vert sync pulse width (upper nibble = lines, lower 4 bits of vertical sync offset) (lower nibble = lines, lower 4 bits of vertical sync pulse width)	0x96		vert sync. offset = 9 lines vert. sync width = 6 lines
0x41	bits 7,6: upper 2 bits of Hor. sync. offset bits 5,4: upper 2 bits of Hor. sync pulse width bits 3,2: upper 2 bits of vert sync offset bits 1,0: upper 2 bits of vert. sync pulse width	0x00	00000000	
0x42	Horizontal Image Size (mm, lower 8 bits)	0xC4		Hor. Image size = 708 mm = 0x2C4
0x43	Vertical Image Size (mm, lower 8 bits)	0x8E		Vert. Image Size = 398 mm = 0x18E (16:9 in this case).
0x44	Horizontal and Vertical Image Size (upper nibble = upper 4 bits of horiz.) (lower nibble = upper 4 bits of vert.)	0x21		
0x45	Horizontal Border (pixels)	0x00		Shall be 0
0x46	Vertical Border (pixels)	0x00		Shall be 0
0x47	Flags (bit 7 = non-interlaced; bit 5,6 = normal display; bit 1, 2, 3,4 = sync description; bit 0 = do not care)	0x18	00011000	Flag = non-interlaced; non-stereo; digital separate; negative V sync; negative H sync

**Table 84 Example EDID Detailed Timing Descriptor for 720x480p (59.94Hz, 16:9)**

Byte# (HEX)	Function	Value (HEX)	Value (binary)	Notes
0x36	Pixel Clock/10,000 (LSB stored first)	0x8C		Pixel Clock = 27.00 MHz
0x37		0x0A		
0x38	Horizontal Active Pixels (lower 8 bits)	0xA0		hor. active pixels = 1440 = 0x5A0
0x39	Horizontal Blanking Pixels (lower 8 bits)	0x14		hor. blanking pixels = 276 = 0x114
0x3A	Horizontal Active and Blanking Pixels (upper nibble = upper 4 bits of active) (lower nibble = upper 4 bits of blanking)	0x51		
0x3B	Vertical Active Lines, lower 8 bits	0xF0		vert. active lines = 240 = 0xF0
0x3C	Vertical Blanking Lines, lower 8 bits	0x16		vert. blanking lines = 22 = 0x16
0x3D	Vertical Active: Vertical Blanking (upper nibble = upper 4 bits of active) (lower nibble = upper 4 bits of blanking)	0x00		
0x3E	Horizontal sync. offset (pixels) (from blanking starts, lower 8 bits)	0x26		offset = 38 pixels = 0x26
0x3F	Horizontal sync pulse width (pixels) (lower 8 bits)	0x7C		width = 124 pixels = 0x7C
0x40	Vert sync offset; Vert sync pulse width (upper nibble = lines, lower 4 bits of vertical sync offset) (lower nibble = lines, lower 4 bits of vertical sync pulse width)	0x43		vert sync. offset = 4 lines vert. sync width = 3 lines
0x41	bits 7,6: upper 2 bits of Hor. sync. offset bits 5,4: upper 2 bits of Hor. sync pulse width bits 3,2: upper 2 bits of vert sync offset bits 1,0: upper 2 bits of vert. sync pulse width	0x00	00000000	
0x42	Horizontal Image Size (mm, lower 8 bits)	0x13		Hor. Image size = 531 mm = 0x213
0x43	Vertical Image Size (mm, lower 8 bits)	0x8E		Vert. Image Size = 398 mm = 0x18E (4:3 in this case).
0x44	Horizontal and Vertical Image Size (upper nibble = upper 4 bits of horiz.) (lower nibble = upper 4 bits of vert.)	0x21		
0x45	Horizontal Border (pixels)	0x00		Shall be 0
0x46	Vertical Border (pixels)	0x00		Shall be 0
0x47	Flags (bit 7 = non-interlaced; bit 5,6 = normal display; bit 1, 2, 3,4 = sync description; bit 0 = do not care)	0x98	10011000	Flag = interlaced; non-stereo; digital separate; negative V sync; negative H sync

**Table 85 Example EDID Detailed Timing Descriptor for 720x480i (59.94Hz, 4:3)**

Byte# (HEX)	Function	Value (HEX)	Value (binary)	Notes
0x36	Pixel Clock/10,000 (LSB stored first)	0x8C		Pixel Clock = 27.00 MHz
0x37		0x0A		
0x38	Horizontal Active Pixels (lower 8 bits)	0xA0		hor. active pixels = 1440 = 0x5A0
0x39	Horizontal Blanking Pixels (lower 8 bits)	0x14		hor. blanking pixels = 276 = 0x114
0x3A	Horizontal Active and Blanking Pixels (upper nibble = upper 4 bits of active) (lower nibble = upper 4 bits of blanking)	0x51		
0x3B	Vertical Active Lines, lower 8 bits	0xF0		vert. active lines = 240 = 0xF0
0x3C	Vertical Blanking Lines, lower 8 bits	0x16		vert. blanking lines = 22 = 0x16
0x3D	Vertical Active: Vertical Blanking (upper nibble = upper 4 bits of active) (lower nibble = upper 4 bits of blanking)	0x00		
0x3E	Horizontal sync. offset (pixels) (from blanking starts, lower 8 bits)	0x26		offset = 38 pixels = 0x26
0x3F	Horizontal sync pulse width (pixels) (lower 8 bits)	0x7C		width = 124 pixels = 0x7C
0x40	Vert sync offset; Vert sync pulse width (upper nibble = lines, lower 4 bits of vertical sync offset) (lower nibble = lines, lower 4 bits of vertical sync pulse width)	0x43		vert sync. offset = 4 lines vert. sync width = 3 lines
0x41	bits 7,6: upper 2 bits of Hor. sync. offset bits 5,4: upper 2 bits of Hor. sync pulse width bits 3,2: upper 2 bits of vert sync offset bits 1,0: upper 2 bits of vert. sync pulse width	0x00	00000000	
0x42	Horizontal Image Size (mm, lower 8 bits)	0xC4		Hor. Image size = 708 mm = 0x2C4
0x43	Vertical Image Size (mm, lower 8 bits)	0x8E		Vert. Image Size = 398 mm = 0x18E (16:9 in this case).
0x44	Horizontal and Vertical Image Size (upper nibble = upper 4 bits of horiz.) (lower nibble = upper 4 bits of vert.)	0x21		
0x45	Horizontal Border (pixels)	0x00		Shall be 0
0x46	Vertical Border (pixels)	0x00		Shall be 0
0x47	Flags (bit 7 = non-interlaced; bit 5,6 = normal display; bit 1, 2, 3,4 = sync description; bit 0 = do not care)	0x98	10011000	Flag = interlaced; non-stereo; digital separate; negative V sync; negative H sync

**Table 86 Example EDID Detailed Timing Descriptor for 720x480i (59.94Hz, 16:9)**

Byte# (HEX)	Function	Value (HEX)	Value (binary)	Notes
0x36	Pixel Clock/10,000 (LSB stored first)	0x01		Pixel Clock = 74.25 MHz
0x37		0x1D		
0x38	Horizontal Active Pixels (lower 8 bits)	0x00		hor. active pixels = 1280 = 0x500
0x39	Horizontal Blanking Pixels (lower 8 bits)	0xBC		hor. blanking pixels = 700 = 0x2BC
0x3A	Horizontal Active and Blanking Pixels (upper nibble = upper 4 bits of active) (lower nibble = upper 4 bits of blanking)	0x52		
0x3B	Vertical Active Lines, lower 8 bits	0xD0		vert. active lines = 720 = 0x2D0
0x3C	Vertical Blanking Lines, lower 8 bits	0x1E		vert. blanking lines = 30 = 0x1E
0x3D	Vertical Active: Vertical Blanking (upper nibble = upper 4 bits of active) (lower nibble = upper 4 bits of blanking)	0x20		
0x3E	Horizontal sync. offset (pixels) (from blanking starts, lower 8 bits)	0xB8		offset = 440 pixels = 0x1B8
0x3F	Horizontal sync pulse width (pixels) (lower 8 bits)	0x28		width = 40 pixels = 0x28
0x40	Vert sync offset; Vert sync pulse width (upper nibble = lines, lower 4 bits of vertical sync offset) (lower nibble = lines, lower 4 bits of vertical sync pulse width)	0x55		vert sync. offset = 5 lines vert. sync width = 5 lines
0x41	bits 7,6: upper 2 bits of Hor. sync. offset bits 5,4: upper 2 bits of Hor. sync pulse width bits 3,2: upper 2 bits of vert sync offset bits 1,0: upper 2 bits of vert. sync pulse width	0x40	01000000	
0x42	Horizontal Image Size (mm, lower 8 bits)	0xC4		Hor. Image size = 708 mm = 0x2C4
0x43	Vertical Image Size (mm, lower 8 bits)	0x8E		Vert. Image Size = 398 mm = 0x18E
0x44	Horizontal and Vertical Image Size (upper nibble = upper 4 bits of horiz.) (lower nibble = upper 4 bits of vert.)	0x21		
0x45	Horizontal Border (pixels)	0x00		Shall be 0
0x46	Vertical Border (pixels)	0x00		Shall be 0
0x47	Flags (bit 7 = non-interlaced; bit 5,6 = normal display; bit 1, 2, 3,4 = sync description; bit 0 = do not care)	0x1E	00011110	Flag = non- interlaced; non-stereo; digital separate; positive V sync; positive H sync

**Table 87 Example EDID Detailed Timing Descriptor for 1280x720p (50 Hz, 16:9)**

Byte# (HEX)	Function	Value (HEX)	Value (binary)	Notes
0x36	Pixel Clock/10,000 (LSB stored first)	0x01		Pixel Clock = 74.25 MHz
0x37		0x1D		
0x38	Horizontal Active Pixels (lower 8 bits)	0x80		Hor. active pixels = 1920 = 0x780
0x39	Horizontal Blanking Pixels (lower 8 bits)	0xD0		hor. blanking pixels = 720 = 0x2D0
0x3A	Horizontal Active and Blanking Pixels (upper nibble = upper 4 bits of active) (lower nibble = upper 4 bits of blanking)	0x72		
0x3B	Vertical Active Lines, lower 8 bits	0x1C		vert. active lines = 540 = 0x21C
0x3C	Vertical Blanking Lines, lower 8 bits	0x16		vert. blanking lines = 22 = 0x16
0x3D	Vertical Active: Vertical Blanking (upper nibble = upper 4 bits of active) (lower nibble = upper 4 bits of blanking)	0x20		
0x3E	Horizontal sync. offset (pixels) (from blanking starts, lower 8 bits)	0x10		offset = 528 pixels = 0x210
0x3F	Horizontal sync pulse width (pixels) (lower 8 bits)	0x2C		width = 44 pixels = 0x2C
0x40	Vert sync offset; Vert sync pulse width (upper nibble = lines, lower 4 bits of vertical sync offset) (lower nibble = lines, lower 4 bits of vertical sync pulse width)	0x25		vert sync. offset = 2 lines vert. sync width = 5 lines
0x41	bits 7,6: upper 2 bits of Hor. sync. offset bits 5,4: upper 2 bits of Hor. sync pulse width bits 3,2: upper 2 bits of vert sync offset bits 1,0: upper 2 bits of vert. sync pulse width	0x80	10000000	
0x42	Horizontal Image Size (mm, lower 8 bits)	0xC4		Hor. Image size = 708 mm = 0x2C4
0x43	Vertical Image Size (mm, lower 8 bits)	0x8E		Vert. Image Size = 398 mm = 0x18E
0x44	Horizontal and Vertical Image Size (upper nibble = upper 4 bits of horiz.) (lower nibble = upper 4 bits of vert.)	0x21		
0x45	Horizontal Border (pixels)	0x00		Shall be 0
0x46	Vertical Border (pixels)	0x00		Shall be 0
0x47	Flags (bit 7 = interlaced; bit 5,6 = normal display; bit 1, 2, 3,4 = sync description; bit 0 = do not care)	0x9E	10011110	Flag = interlaced; non-stereo; digital separate; positive V sync; positive H sync

**Table 88 Example EDID Detailed Timing Descriptor for 1920x1080i (50 Hz, 16:9)**

Byte# (HEX)	Function	Value (HEX)	Value (binary)	Notes
0x36	Pixel Clock/10,000 (LSB stored first)	0x8C		Pixel Clock = 27.00 MHz
0x37		0x0A		
0x38	Horizontal Active Pixels (lower 8 bits)	0xD0		hor. active pixels = 720 = 0x2D0
0x39	Horizontal Blanking Pixels (lower 8 bits)	0x90		hor. blanking pixels = 144 = 0x90
0x3A	Horizontal Active and Blanking Pixels (upper nibble = upper 4 bits of active) (lower nibble = upper 4 bits of blanking)	0x20		
0x3B	Vertical Active Lines, lower 8 bits	0x40		vert. active lines = 576 = 0x240
0x3C	Vertical Blanking Lines, lower 8 bits	0x31		vert. blanking lines = 49 = 0x31
0x3D	Vertical Active: Vertical Blanking (upper nibble = upper 4 bits of active) (lower nibble = upper 4 bits of blanking)	0x20		
0x3E	Horizontal sync. offset (pixels) (from blanking starts, lower 8 bits)	0x0C		offset = 12 pixels = 0x0C
0x3F	Horizontal sync pulse width (pixels) (lower 8 bits)	0x40		Width = 64 pixels = 0x40
0x40	Vert sync offset; Vert sync pulse width (upper nibble = lines, lower 4 bits of vertical sync offset) (lower nibble = lines, lower 4 bits of vertical sync pulse width)	0x55		vert sync. offset = 5 lines vert. sync width = 5 lines
0x41	bits 7,6: upper 2 bits of Hor. sync. offset bits 5,4: upper 2 bits of Hor. sync pulse width bits 3,2: upper 2 bits of vert sync offset bits 1,0: upper 2 bits of vert. sync pulse width	0x00	00000000	
0x42	Horizontal Image Size (mm, lower 8 bits)	0x13		Hor. Image size = 531 mm = 0x213
0x43	Vertical Image Size (mm, lower 8 bits)	0x8E		Vert. Image Size = 398 mm = 0x18E (4:3 in this case).
0x44	Horizontal and Vertical Image Size (upper nibble = upper 4 bits of horiz.) (lower nibble = upper 4 bits of vert.)	0x21		
0x45	Horizontal Border (pixels)	0x00		Shall be 0
0x46	Vertical Border (pixels)	0x00		Shall be 0
0x47	Flags (bit 7 = non-interlaced; bit 5,6 = normal display; bit 1, 2, 3,4 = sync description; bit 0 = do not care)	0x18	00011000	Flag = non-interlaced; non-stereo; digital separate; negative V sync; negative H sync

**Table 89 Example EDID Detailed Timing Descriptor for 720x576p (50 Hz, 4:3)**

Byte# (HEX)	Function	Value (HEX)	Value (binary)	Notes
0x36	Pixel Clock/10,000 (LSB stored first)	0x8C		Pixel Clock = 27.00 MHz
0x37		0x0A		
0x38	Horizontal Active Pixels (lower 8 bits)	0xD0		hor. active pixels = 720 = 0x2D0
0x39	Horizontal Blanking Pixels (lower 8 bits)	0x90		hor. blanking pixels = 144 = 0x90
0x3A	Horizontal Active and Blanking Pixels (upper nibble = upper 4 bits of active) (lower nibble = upper 4 bits of blanking)	0x20		
0x3B	Vertical Active Lines, lower 8 bits	0x40		vert. active lines = 576 = 0x240
0x3C	Vertical Blanking Lines, lower 8 bits	0x31		vert. blanking lines = 49 = 0x31
0x3D	Vertical Active: Vertical Blanking (upper nibble = upper 4 bits of active) (lower nibble = upper 4 bits of blanking)	0x20		
0x3E	Horizontal sync. offset (pixels) (from blanking starts, lower 8 bits)	0x0C		offset = 12 pixels = 0x0C
0x3F	Horizontal sync pulse width (pixels) (lower 8 bits)	0x40		width = 64 pixels = 0x40
0x40	Vert sync offset; Vert sync pulse width (upper nibble = lines, lower 4 bits of vertical sync offset) (lower nibble = lines, lower 4 bits of vertical sync pulse width)	0x55		vert sync. offset = 5 lines vert. sync width = 5 lines
0x41	bits 7,6: upper 2 bits of Hor. sync. offset bits 5,4: upper 2 bits of Hor. sync pulse width bits 3,2: upper 2 bits of vert sync offset bits 1,0: upper 2 bits of vert. sync pulse width	0x00	00000000	
0x42	Horizontal Image Size (mm, lower 8 bits)	0xC4		Hor. Image size = 708 mm = 0x2C4
0x43	Vertical Image Size (mm, lower 8 bits)	0x8E		Vert. Image Size = 398 mm = 0x18E (16:9 in this case).
0x44	Horizontal and Vertical Image Size (upper nibble = upper 4 bits of horiz.) (lower nibble = upper 4 bits of vert.)	0x21		
0x45	Horizontal Border (pixels)	0x00		Shall be 0
0x46	Vertical Border (pixels)	0x00		Shall be 0
0x47	Flags (bit 7 = non-interlaced; bit 5,6 = normal display; bit 1, 2, 3,4 = sync description; bit 0 = do not care)	0x18	00011000	Flag = non-interlaced; non-stereo; digital separate; negative V sync; negative H sync

**Table 90 Example EDID Detailed Timing Descriptor for 720x576p (50 Hz, 16:9)**



Byte# (HEX)	Function	Value (HEX)	Value (binary)	Notes
0x36	Pixel Clock/10,000 (LSB stored first)	0x8C		Pixel Clock = 27.00 MHz
0x37		0x0A		
0x38	Horizontal Active Pixels (lower 8 bits)	0xA0		hor. active pixels = 1440 = 0x5A0
0x39	Horizontal Blanking Pixels (lower 8 bits)	0x20		hor. blanking pixels = 288 = 0x120
0x3A	Horizontal Active and Blanking Pixels (upper nibble = upper 4 bits of active) (lower nibble = upper 4 bits of blanking)	0x51		
0x3B	Vertical Active Lines, lower 8 bits	0x20		vert. active lines = 288 = 0x120
0x3C	Vertical Blanking Lines, lower 8 bits	0x18		vert. blanking lines = 24 = 0x18
0x3D	Vertical Active: Vertical Blanking (upper nibble = upper 4 bits of active) (lower nibble = upper 4 bits of blanking)	0x10		
0x3E	Horizontal sync. offset (pixels) (from blanking starts, lower 8 bits)	0x18		offset = 24 pixels = 0x18
0x3F	Horizontal sync pulse width (pixels) (lower 8 bits)	0x7E		Width = 126 pixels = 0x7C
0x40	Vert sync offset; Vert sync pulse width (upper nibble = lines, lower 4 bits of vertical sync offset) (lower nibble = lines, lower 4 bits of vertical sync pulse width)	0x23		vert sync. offset = 2 lines vert. sync width = 3 lines
0x41	bits 7,6: upper 2 bits of Hor. sync. offset bits 5,4: upper 2 bits of Hor. sync pulse width bits 3,2: upper 2 bits of vert sync offset bits 1,0: upper 2 bits of vert. sync pulse width	0x00	00000000	
0x42	Horizontal Image Size (mm, lower 8 bits)	0x13		Hor. Image size = 531 mm = 0x213
0x43	Vertical Image Size (mm, lower 8 bits)	0x8E		Vert. Image Size = 398 mm = 0x18E (4:3 in this case).
0x44	Horizontal and Vertical Image Size (upper nibble = upper 4 bits of horiz.) (lower nibble = upper 4 bits of vert.)	0x21		
0x45	Horizontal Border (pixels)	0x00		Shall be 0
0x46	Vertical Border (pixels)	0x00		Shall be 0
0x47	Flags (bit 7 = non-interlaced; bit 5,6 = normal display; bit 1, 2, 3,4 = sync description; bit 0 = do not care)	0x98	10011000	Flag = interlaced; non-stereo; digital separate; negative V sync; negative H sync

**Table 91 Example EDID Detailed Timing Descriptor for 720x576i (50 Hz, 4:3)**

Byte# (HEX)	Function	Value (HEX)	Value (binary)	Notes
0x36	Pixel Clock/10,000 (LSB stored first)	0x8C		Pixel Clock = 27.00 MHz
0x37		0x0A		
0x38	Horizontal Active Pixels (lower 8 bits)	0xA0		hor. active pixels = 1440 = 0x5A0
0x39	Horizontal Blanking Pixels (lower 8 bits)	0x20		hor. blanking pixels = 288 = 0x120
0x3A	Horizontal Active and Blanking Pixels (upper nibble = upper 4 bits of active) (lower nibble = upper 4 bits of blanking)	0x51		
0x3B	Vertical Active Lines, lower 8 bits	0x20		vert. active lines = 288 = 0x120
0x3C	Vertical Blanking Lines, lower 8 bits	0x18		vert. blanking lines = 24 = 0x18
0x3D	Vertical Active: Vertical Blanking (upper nibble = upper 4 bits of active) (lower nibble = upper 4 bits of blanking)	0x10		
0x3E	Horizontal sync. offset (pixels) (from blanking starts, lower 8 bits)	0x18		offset = 24 pixels = 0x18
0x3F	Horizontal sync pulse width (pixels) (lower 8 bits)	0x7E		Width = 126 pixels = 0x7E
0x40	Vert sync offset; Vert sync pulse width (upper nibble = lines, lower 4 bits of vertical sync offset) (lower nibble = lines, lower 4 bits of vertical sync pulse width)	0x23		vert sync. offset = 2 lines vert. sync width = 3 lines
0x41	bits 7,6: upper 2 bits of Hor. sync. offset bits 5,4: upper 2 bits of Hor. sync pulse width bits 3,2: upper 2 bits of vert sync offset bits 1,0: upper 2 bits of vert. sync pulse width	0x00	00000000	
0x42	Horizontal Image Size (mm, lower 8 bits)	0xC4		Hor. Image size = 708 mm = 0x2C4
0x43	Vertical Image Size (mm, lower 8 bits)	0x8E		Vert. Image Size = 398 mm = 0x18E (16:9 in this case).
0x44	Horizontal and Vertical Image Size (upper nibble = upper 4 bits of horiz.) (lower nibble = upper 4 bits of vert.)	0x21		
0x45	Horizontal Border (pixels)	0x00		Shall be 0
0x46	Vertical Border (pixels)	0x00		Shall be 0
0x47	Flags (bit 7 = non-interlaced; bit 5,6 = normal display; bit 1, 2, 3,4 = sync description; bit 0 = do not care)	0x98	10011000	Flag = interlaced; non-stereo; digital separate; negative V sync; negative H sync

**Table 92 Example EDID Detailed Timing Descriptor for 720x576i (50 Hz, 16:9)**

**Annex B Application to DVI 1.0 (Normative)**

All mandatory aspects of DVI 1.0 [4] shall be implemented with the exception of those expressly identified as optional or informative when DVI 1.0 is used to implement CEA-861-E. DVI does not support transport of CEA InfoFrames, audio or  $YCbCr$  pixel data. However, CEA-861-E can still be implemented on DVI 1.0 (with reduced functionality) as explained at the beginning of Section 6.

The EDID content shall comply with EDID data structure Version 1, Revision 3 [10].

All sections in Annex B are normative when DVI 1.0 is used to implement CEA-861-E except as otherwise noted.

**B.1 Connector and Cable**

The connector used shall be DVI-Digital, Single Link [4].

The cable, if supplied with the product, shall be compliant with the DVI specification at maximum pixel clock frequency compatible with the product.

**B.2 Digital Content Protection**

High-bandwidth Digital Content Protection (HDCP) [3] is available to authenticate display devices and encrypt content transmitted across the DVI interface.

### Annex C Application to Open LDI (Normative)

All mandatory aspects of OpenLDI 0.95 [8] shall be implemented with the exception of those expressly identified as optional or informative in that standard when OpenLDI 0.95 is used to implement CEA-861-E. It should be noted that at the time of this writing, a version of OpenLDI that supports transport of CEA InfoFrames was not available. However, CEA-861-E can still be implemented on OpenLDI 0.95 (with reduced functionality) as explained in Section 6.

All sections in this Annex are normative when OpenLDI 0.95 is used to implement CEA-861-E except as otherwise noted.

#### C.1 Open LDI Data and Control Signals

OpenLDI has two options for display synchronization:

- a) DC Balance Mode:
- b) Non DC Balance Mode:

In DC Balance mode synchronization is accomplished by transmitting control signals during the Display blanking intervals as shown in Figure 7.

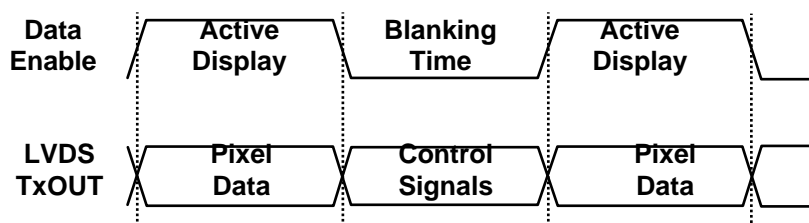


Figure 7 OpenLDI Synchronization

In the single or dual LVDS bus mode (24 or 48 bit Total), the control signals are transmitted over 7 transition words on specific output signals during the blanking period as indicated in Table 93.

Control Signal	Signal Level	Output Signal	Data Pattern
DE	High	CLK1 and CLK2	1111000 or 1110000
	Low		1111100 or 1100000
HSYNC	High	A0	1100000 or 1111100
	Low		1110000 or 1111000
VSYNC	High	A1	1100000 or 1111100
	Low		1110000 or 1111000

Table 93 OpenLDI Control Signals

#### C.2 Non DC Balanced Mode

Control signals are transmitted as part the LVDS serialized data stream. The controls signals are then de-serialized and regenerated at the receiver outputs to the EDTV/HDTV.

#### C.3 OpenLDI Cabling Information

An OpenLDI cable assembly shall consist of a cable meeting the requirements of this section with an OpenLDI plug on each end or an OpenLDI plug on one end and the other end permanently affixed to the display device. Acceptable cables for OpenLDI may use either shielded or unshielded twisted pairs. It is up to the manufacturer of the OpenLDI equipment to use the grade and type of cable required to meet applicable regulatory requirements. Adherence to CEA-861-E does not guarantee regulatory compliance.

When the OpenLDI is an interface internal to an assembly and not accessible externally, the OpenLDI cable may be replaced with any cable or connection means appropriate to the requirements of the assembly.

### **C.3.1 Cable Length**

The maximum cable length shall be 10m.

### **C.3.2 Number of Signal Conductors**

The OpenLDI cable shall comprise 11 twisted pairs and 10 individual conductors.

### **C.3.3 Wire Gauge**

Each conductor in an OpenLDI cable shall be no less than 28AWG.

### **C.3.4 Conductor Resistance**

The resistance of a single conductor of an OpenLDI cable shall not exceed  $4\Omega$  when the conductor is of the maximum length specified in CEA-861-E.

### **C.3.5 Insulation**

Each conductor in the cable shall be separately insulated. The minimum insulation resistance shall be  $1G\Omega$ .

### **C.3.6 Shield Requirement**

The OpenLDI cable shall be encompassed by a single shield, surrounding all conductors in the cable. The shield shall provide a minimum of 90% coverage.

For shielded twisted pair cable, each twisted pair shall be shielded individually. Each shield shall provide a minimum of 90% coverage.

### **C.3.7 Single Twisted Pair Transmission Skew**

The differential time of transmission (single pair transmission skew) of a pulse through a single differential pair in an OpenLDI cable shall not exceed 300ps.

### **C.3.8 Multiple Twisted Pair Transmission Skew**

The differential time of transmission (pair to pair transmission skew) of a pulse through any two differential pairs in an OpenLDI cable shall not exceed 1 bit time.

### **C.3.9 USB Cable Requirements**

The conductors used for transmission of USB signals on the OpenLDI cable shall meet the requirements stated in the Universal Serial Bus Specification, Version 1.0, January 15, 1996.

### **C.3.10 DDC Cable Requirements**

The conductors used for transmission of DDC signals on the OpenLDI cable shall meet the requirements stated in the VESA Display Data Channel Command Interface (DDC/CI) Standard, Version 1, August 14, 1998 [11].

More information on the connector is available in Section 7.2 of the OpenLDI specification [8].

## Annex D Application to HDMI (Informative)

### D.1 InfoPackets

HDMI carries each InfoFrame in its own HDMI packet. The HDMI packet type for an InfoFrame packet is equal to 0x80+InfoFrame Type, therefore, only InfoFrames with Types less than 0x80 may be transmitted. Including Type, Version, and Length fields, InfoFrames of at most 30 bytes are supported. A checksum is present in each InfoFrame.

Refer to the HDMI Specification for more detail on the packetization of InfoFrames.

### D.2 EDID

A sink using an HDMI input shall contain an EDID consisting of a single E-EDID Version 1, Revision 3 block and at least one CEA Extension version 3.

A sink that supports either type of  $Y_{C_B}C_R$  pixel data (4:2:2 or 4:4:4) shall support both types and therefore shall set both bits 4 and 5 of byte 3 of all CEA EDID Extensions within the EDID. A sink that does not support  $Y_{C_B}C_R$  pixel data shall have both bits 4 and 5 clear. See D.6 for an example.

If the sink supports any type of digital audio on this interface, then it shall also support Basic Audio and shall indicate this by setting the Basic Audio bit (bit 6).

Bit 7 of byte 3 shall be set if the sink underscans IT video formats by default.

### D.3 Audio

HDMI [50] is capable of supporting a variety of audio formats, including uncompressed digital audio (PCM), in an IEC 60958-3 [13] compliant stream at up to 8 channels, up to 192 kHz and up to 24 bits/sample, and compressed digital audio, in an IEC 61937-2 [72] compliant stream, up to 192 kHz.

HDMI [50] relies on the defined audio discovery mechanisms present in the CEA EDID Extension Version 3.

The Audio InfoFrame, the IEC 60958-3 [13] "Channel Status" bits, and the IEC 61937-2 [72] "Burst Info" bits are used to describe the transmitted audio stream. The Audio InfoFrame CT (coding type), SS (sample size) and SF (sample frequency) fields are required to be 0 ("Refer to Stream Header") to avoid redundancy with the same data already contained within the IEC 60958-3 [13] stream data.

### D.4 HDCP

High-bandwidth Digital Content Protection (HDCP) version 1.1 [3] or later, is available to protect the audio and video data carried on an HDMI link.

### D.5 Additional Information

HDMI information is available from HDMI Licensing (see Section 2.1.2.2).

HDCP information is available from Digital-CP, LLC (see Section 2.1.1.2).

### D.6 Example EDID Using Elements of CEA Block Tag Extension (Applicable to HDMI)

Table 99 contains an example implementation of EDID utilizing elements of the CEA Block Tag Extension that were not addressed in Annex A. These elements are Short Video Descriptors, Audio Descriptors, Speaker Allocation Block, and a Vendor-Specific Data Block. This example is applicable to HDMI implementations. Elements of the Example EDID are addressed individually, in the following subsections.

#### D.6.1 First Monitor Descriptor (Monitor Name) and Second Monitor Descriptor (Monitor Range Limits)

Although Annex A requires that two of the four 18-byte detailed timing descriptors be a Monitor Name Descriptor and a Monitor Descriptor, it is possible that implementations designed for Personal Computers (e.g., multimedia applications), may contain a different set of data. For that reason, sources adhering to

CEA-861-E should be designed without dependency upon specific data within these blocks that prevent collection and interpretation of subsequent data blocks.

### D.6.2 Extension Flag and Checksum

The Extension Flag and Checksum are defined the same as in Annex A.

### D.6.3 CEA Extension Header (Block 1)

The CEA Extension Header is a four-data bytes located in address range 0x80 through 0x83. The first byte is the tag used to identify the extension. The number assigned by VESA to this tag is 0x02. Following the CEA Extension Tag is the Revision Number location. In this example, the Revision Number is set to 0x03. Please note that all Revision numbers are backward compatible. Sources should not have a dependency upon Revision Numbers.

Table 94 contains data based upon the tables presented in this Annex. In this example, the CEA Extension Tag is located at address 0x80 followed by Revision Number, Byte Number Offset, and Reserved (i.e., 0x00). The data is set as prescribed by CEA-861-E.

Address Hex	Example Data Hex Dec		Name of Block	Description	Remarks
0x80	0x02	2	CEA Extension Header	Tag	Block One
0x81	0x03	3		Revision Number	Start of CEA Block Tag Extension
0x82	0x1A	26			Byte Offset
0x83	0x71	113		Global Declarations	DTV, YC <sub>B</sub> CR (4:4:4), YC <sub>B</sub> CR (4:2:2)

**Table 94 CEA Extension Header (Block 1)**

### D.6.4 CEA Data Block Collection

The CEA Data Block Collection is within the CEA Extension Block and declares CEA Short Video Descriptors, Audio capabilities, Speaker configuration, a Vendor Specific Block that requires an Identifier code, and a Vendor Specific Payload block that is used to carry additional and optional data. As noted in Section 7.5, the Data Block ordering sequence is not constrained and various combinations are possible; and therefore, the examples provided herein are based upon one possible combination.

### D.6.5 Video Data Block

The purpose of this block is for listing Short Video Descriptors (SVDs). Short Video Descriptors are used to declare video formats with one byte as contrasted with 18 bytes for Detailed Timing Descriptors, which is useful in economizing memory space. The preferred SVD is listed first. Subsequent SVDs are of decreasing preference.

As defined in Table 40 (General Tag Format), the first byte is used to signify a Video Tag Code and Payload Length. Bits 5 to 7 designate the Tag Code and payload length is defined by bits 0 to 4.

The payload byte structure is defined in Table 44. Bits 0 through 6 are used for a Video Identification Codes as defined in Table 4; and bit 7 (MSB) is a marker bit called "Native." If bit 7 is set to '1', the format is a "Native format" (see Section 2.2), and if set to 'zero' the format is not "Native."

In the example, as shown in Table 95, bits 5 through 7 located in address 0x84 are set to Tag Code 2 (0x04) designating a Video Data Block; and bits 0 to 4 is set to 0x7 indicating seven bytes of data payload. Addresses 0x85 through 0x8B contain one discrete Short Video Descriptor code per byte.

Address Hex	Example Data Hex	Dec	Name of Block	Description	Remarks
0x84	0x47	71	<b>Video Data Block</b>	Start of data block collection. Includes Tag Code and length of following data block payload	0x47 = Video Block (code = 2) and seven bytes of data payload
0x85	0x85	132		1 <sup>st</sup> Short Video Descriptor	1920x1080i @ 59.94/60 Hz 16:9 Native Mode
0x86	0x02	2		2 <sup>nd</sup> Short Video Descriptor	720x480p 59.94/60 Hz 4:3
0x87	0x03	3		3 <sup>rd</sup> Short Video Descriptor	720x480p 59.94/60 Hz 16:9
0x88	0x04	4		4 <sup>th</sup> Short Video Descriptor	1280x720p 59.94/60 Hz 16:9
0x89	0x06	6		5 <sup>th</sup> Short Video Descriptor	720(1440)x480i 59.94/60 Hz 4:3
0x8A	0x07	7		6 <sup>th</sup> Short Video Descriptor	720(1440)x480i 59.94/60 Hz 16:9
0x8B	0x01	1		7 <sup>th</sup> Short Video Descriptor	640x480p 59.94/60 Hz 4:3

**Table 95 Video Data Block**

### D.6.6 CEA Audio Block

The Audio Data Block is used to declare format, frequency, and bit-rate. The structure of this table is defined in Table 26 with subsequent tables addressing the General Tag Format, Short Audio Descriptors, and Audio Format Codes. Multiple, Short Audio Descriptors may be used in this block.

The first byte in this block is the General Format Tag and is the same structure as the Video Data Block as defined in Table 27, General Tag Format. The Tag Code occupies bits 5 and 7; and Payload Length is placed in bits 0 through 4. Audio Tag Codes are listed in Table 34, Audio Format Codes. Three bytes of data are used for each Short Audio Descriptor.

Short Audio Descriptors are defined in Table 45 through Table 49; with Table 45 dealing with Linear PCM Audio and compressed audio formats in the remaining tables. Each Descriptor consists of three data bytes.

In Table 96, as with the Video Data Block, the first byte (0x8C) is used to indicate block type and payload length in bytes. Audio Tag Code 1 (0x02) is placed in bits 3 and 7; and bits 0 to 4 contains 0x3 for a payload of three bytes. The Short Audio Descriptor begins at address 0x8D and ends with 0x8F. In the first byte of the descriptor, bit 7 is reserved and set to 'zero'. Bits 3 through 6 contain the Audio Format code as defined in Table 34; in this example Code 1 for Linear PCM is indicated with bit 6...3 set to '0001'. Bits 0 through 2 designate the maximum number of channels as one channel audio (0x1). The second descriptor byte uses seven bits to declare frequency characteristics. Frequencies of 32 kHz, 44.1 kHz, and 48 kHz are indicated by the 0x07 as defined in Table 45. In address 0x8E; and in the next address 0x07 is used to declare bit-rates of 16, 20, and 24 bit audio per Table 45. This example does not illustrate Short Audio Descriptors for compressed audio formats.

Address Hex	Example Data Hex	Dec	Name of Block	Description	Remarks
0x8C	0x23	35	Audio Data Block	Start of Audio Block	0x23 = Audio Block (code = 1) and three bytes of data payload.
0x8D	0x09	9		Audio Format	Code 1 = Linear PCM (IEC 60985)
0x8E	0x07	7		Frequency	0x07 = 32 kHz, 44.1 kHz, 48 kHz
0x8F	0x07	7		Bit Rate	0x07 = 16 bit, 20 bit, 24 bit

**Table 96 Audio Data Block**

### D.6.7 Speaker Allocation Block

The Speaker Allocation Data Block is used to declare number of speakers and configuration. As with preceding blocks a Tag Code and payload length are designated in the first data byte. The data block payload begins with the second byte and is used to indicate speaker count and configuration (see Table 50). The last payload byte is set to zero.



In Table 97, address 0x90 contains a value 0x83 which designates the beginning of the Speaker Allocation Block and data payload. In this example, the Speaker Allocation Data Block is indicated by Code 4 per Table 50. The data payload is set to three bytes. At address 0x91 FL/FR (2 Channel Stereo) is chosen by setting the bits to 0x01. The two remaining addresses have the bits set to zero as required by Table 40.

Address Hex	Example Data Hex	Dec	Name of Block	Description	Remarks
0x90	0x83	131	Speaker Allocation Block	Start of Speaker Allocation	0x83 =Speaker Allocation Data Block (code = 4) and three bytes of data payload.
0x91	0x01	1		Speaker Designation	0x01 = FL / FR (2 Channel Stereo.)
0x92	0x00	0		Speaker Designation	Bits 0 to 2
0x93	0x00	0		Reserved	Always zero

**Table 97 Speaker Data Block**

### D.6.8 Vendor Specific Block

The Vendor Specific Data Block was originally intended as an option to place data not specified by CEA-861-E; data that a manufacturer may care to use. However, the HDMI specification makes requirements that are addressed below. Users are advised to treat this data block with care.

The first address requires a Tag Code and data payload length in the first byte. The next three addresses house a 24-bit IEEE Registration Identifier (three bytes); and a Vendor Specific Payload in the remaining bytes. In the case of HDMI compliant devices the IEEE Registration is used as an 'HDMI Identifier.' After the HDMI Identifier two bytes are used to identify the port configuration. Users are advised to refer to the HDMI specification for details. For the purposes of this example the HDMI Identifier and Physical Source Address are presented.

As shown in Table 98, the first address, 0x94, the Tag Code is listed as '3' and the payload length is set to '5' bytes. The second, third and fourth bytes, addresses 0x95, 0x96 and 0x97, contain the HDMI LLC's 24-bit IEEE registration Organizationally Unique Identifier (OUI) 0x00030C, which is coded least significant byte first. The Physical Source Address is found in address 0x98 and 0x99 and according to the HDMI specification, the two bytes are used as Identity Port Configuration with 0x1000 indicating a single port sink. The last byte in the data payload or Vendor Specific Payload address is set to zero.

Address Hex	Example Data Hex	Dec	Name of Block	Description	Remarks
0x94	0x65	101	Vendor Specific Data Block	Start of Vendor Specific Block	0x65 = Vendor Specific Block (code = 3) and five bytes of data payload.
0x95	0x03	3		24-bit IEEE Registration	HDMI Identifier = 0x000C03 (The big-endian HDMI-LLC's 24-bit OUI Registration Identifier 0x000C03 is placed into the EDID in little-endian order.)
0x96	0x0C	12			
0x97	0x00	0			
0x98	0x10	16		Components of Source Physical Address	Sink identifies location of source in signal path relative to root display as ABCD. Example shows input '1' of root display (A=1, B=0, C=0, D=0 or 0x1000).
0x99	0x00	0			

**Table 98 Vendor Specific Data Block**

### D.6.9 Complete CEA-861-E Example with Block Tag Extension

Table 99 contains an example implementation of E-EDID utilizing elements of the CEA Block Tag Extension that were not addressed in Annex A. These elements are Short Video Descriptors, Audio Descriptors, Speaker Allocation Block, and a Vendor-Specific Data Block. This example is applicable to HDMI implementations.

Address Hex	Example Data Hex	Dec	Name of Block	Description	Remarks
0x00	0x00	0	Block Zero Header		Fixed Value
0x01	0xFF	255			
0x02	0xFF	255			
0x03	0xFF	255			
0x04	0xFF	255			
0x05	0xFF	255			
0x06	0xFF	255			
0x07	0x00	0			
0x08	0x0C	12	Vendor / Product ID	Manufacturer Name	CEA
0x09	0xA1	161		Product Code	Used to differentiate between different models from the same manufacturer.
0x0A	0x00	0		Serial Number	Optional. The serial number can also be stored in a separate descriptor block
0x0B	0x00	0			
0x0C	0x00	0			
0x0D	0x00	0			
0x0E	0x00	0		Week of Manufacture	Optional. If this field is unused, the value should be set to 0.
0x0F	0x00	0			
0x10	0x00	0		Year of Manufacture	Year 2005
0x11	0x0F	15		EDID Structure Version / Revision	Version #
0x12	0x01	1	Revision #		3
0x13	0x03	3	Basic Display Parameters / Features	Video Input Definition	Digital, VESA DFP1X : not compatible
0x14	0x80	128		Max. Horizontal Image Size in cm	Optional. The system should not make any assumption regarding display size
0x15	0x50	80		Max. Vertical Image Size in cm	Optional. See above.
0x16	0x2D	45		Gamma: (gamma x 100)-100 = value	Example is: (gamma = 2.2) (2.2 x 100)-100 = 120
0x17	0x78	120		Feature Support	0x0A denotes: RGB color Display type, preferred timing: first detailed timing block. GTF timing: not supported. Standby mode: not supported, suspend mode: not supported, active off: not supported
0x18	0x0A	10			

**Table 99 CEA-861-E EDID Example with Block Tag Extension**

Address Hex	Example Data Hex	Dec	Name of Block	Description	Remarks	
0x19	0x0D	13	Color Characteristics	Red/Green Low Bits		
0x1A	0xC9	201		Blue/White Low Bits		
0x1B	0xA0	160		Red-x	0.625	
0x1C	0x57	87		Red-y	0.340	
0x1D	0x47	71		Green-x	0.280	
0x1E	0x98	152		Green-y	0.595	
0x1F	0x27	39		Blue-x	0.155	
0x20	0x12	18		Blue-y	0.070	
0x21	0x48	72		White-x	0.283	
0x22	0x4C	76		White-y	0.298	
0x23	0x20	32		Established Timings	Timing 1	640x480 @ 60Hz
0x24	0x00	0			Timing 2	None
0x25	0x00	0	Manufacturer's Reserved Timing		None	
0x26	0x01	1	Standard Timing ID # 1-8	Standard Timing ID #1	PC Application	
0x27	0x01	1		Standard Timing ID #2	PC Application	
0x28	0x01	1		Standard Timing ID #3	PC Application	
0x29	0x01	1		Standard Timing ID #4	PC Application	
0x2A	0x01	1		Standard Timing ID #5	PC Application	
0x2B	0x01	1		Standard Timing ID #6	PC Application	
0x2C	0x01	1		Standard Timing ID #7	PC Application	
0x2D	0x01	1		Standard Timing ID #8	PC Application	
0x2E	0x01	1				
0x2F	0x01	1				
0x30	0x01	1				
0x31	0x01	1				
0x32	0x01	1				
0x33	0x01	1				
0x34	0x01	1				
0x35	0x01	1				

**Table 99 CEA-861-E EDID Example with Block Tag Extension (continued)**

Address Hex	Example Data Hex	Example Data Dec	Name of Block	Description	Remarks
0x36	0x01	1	First Detailed Timing Descriptor (Preferred)	Pixel Clock	74.25 MHz
0x37	0x1D	29		H Active	1920 pixels
0x38	0x80	128		H Blanking	280 pixels
0x39	0x18	24		H Active: H Blanking	
0x3A	0x71	113		V Active	540 lines
0x3B	0x1C	28		V Blanking	22 lines
0x3C	0x16	22		V Active: V Blanking	
0x3D	0x20	32		H Sync Offset	88 pixels
0x3E	0x58	88		H Sync Pulse Width	44 pixels
0x3F	0x2C	44		VS Offset: VS Pulse Width	2 lines, 5 lines
0x40	0x25	37		HS Offset: HS Pulse Width: VS Offset: VS Pulse Width	
0x41	0x00	0		H Image Size	800 mm (lower 8 bits)
0x42	0x20	32		V Image Size	450 mm (lower 8 bits)
0x43	0xC2	194		H&V Image Size	Upper 4 bits of H & V size
0x44	0x31	49		H Border	0 lines
0x45	0x00	0		V Border	0 pixels
0x46	0x00	0		Flags	Interlaced, normal display no stereo, digital separate, Vsync polarity is positive, Hsync polarity is positive
0x47	0x9E	158			
0x48	0x8C	140	Second Detailed Timing Descriptor (Next Preferred)	Pixel Clock	27 MHz
0x49	0x0A	10		H Active	720 pixels
0x4A	0xD0	208		H Blanking	138 pixels
0x4B	0x8A	138		H Active: H Blanking	
0x4C	0x20	32		V Active	480 lines
0x4D	0xE0	224		V Blanking	45 lines
0x4E	0x2D	45		V Active: V Blanking	
0x4F	0x10	16		H Sync Offset	16 pixels
0x50	0x10	16		H Sync Pulse Width	62 pixels
0x51	0x3E	62		VS Offset: VS Pulse Width	9 lines, 6 lines
0x52	0x96	150		HS Offset: HS Pulse Width: VS Offset: VS Pulse Width	
0x53	0x00	0		H Image Size	600 mm (lower 8 bits)
0x54	0x58	88		V Image Size	450 mm (lower 8 bits)
0x55	0xC2	194		H&V Image Size	Upper 4 bits of H & V size
0x56	0x21	33		H Border	0 lines
0x57	0x00	0		V Border	0 pixels
0x58	0x00	0		Flags	non interlaced, normal display no stereo, digital separate, V. and H. sync polarity is negative
0x59	0x18	24			

Table 99 CEA-861-E EDID Example with Block Tag Extension (continued)

Address Hex	Example Data Hex	Dec	Name of Block	Description	Remarks
0x5A	0x00	0	Monitor Descriptor Currently Mandatory (Monitor Name)	Flag	
0x5B	0x00	0		Flag (Reserved)	
0x5C	0x00	0		Data Type Tag	Monitor name type
0x5D	0xFC	252		Flag	
0x5E	0x00	0		M	
0x5F	0x4D	77		Y	
0x60	0x59	89			
0x61	0x20	32			
0x62	0x48	72		H	
0x63	0x44	68		D	
0x64	0x54	84		T	
0x65	0x56	86		V	
0x66	0x0A	10			
0x67	0x20	32			
0x68	0x20	32			
0x69	0x20	32			
0x6A	0x20	32			
0x6B	0x20	32			
0x6C	0x00	0	Second Monitor Descriptor Currently Mandatory (range limits, binary coded)	Flag	
0x6D	0x00	0		Flag (Reserved)	
0x6E	0x00	0		Data Type Tag	Monitor Range limits, binary coded, mandatory block
0x6F	0xFD	253		Flag	
0x70	0x00	0		Min Vertical Rate in Hz	59 Hz
0x71	0x3B	59		Max Vertical Rate in Hz	61 Hz
0x72	0x3D	61		Min Horizontal Rate in kHz	15 kHz
0x73	0x0F	15		Max Horizontal Rate in kHz	46 kHz
0x74	0x2E	46		Max Supported pixel clock rate in MHz/10	80 MHz
0x75	0x08	8		Tag for secondary timing formula, GTF (0x00=not used)	No secondary timing formula supported
0x76	0x00	0		Fixed	
0x77	0x0A	10		Fixed	
0x78	0x20	32		Fixed	
0x79	0x20	32		Fixed	
0x7A	0x20	32	Fixed		
0x7B	0x20	32	Fixed		
0x7C	0x20	32	Fixed		
0x7D	0x20	32	Fixed		

Table 99 CEA-861-E EDID Example with Block Tag Extension (continued)

Address Hex	Example Data Hex	Dec	Name of Block	Description	Remarks
0x7E	0x01	1	Extension Flag	Number of 128 bytes blocks to follow	
0x7F	0xC0	192	Checksum	Checksum	Block 0 sum = 0xFF&(0x100-(0x1B40&0xFF)) = 0xC0
0x80	0x02	2	CEA Extension Header	Tag	Block One
0x81	0x03	3		0x03 (see Annex A.2.13)	Revision Number (Start of VESA CEA Block Tag Extension)
0x82	0x1A	26		0x04, no data in Reserved	Byte Offset
0x83	0x71	113		Global Declarations	Content depends on implementation DTV, YC <sub>B</sub> C <sub>R</sub> (4:4:4), YC <sub>B</sub> C <sub>R</sub> (4:2:2)

**Table 99 CEA-861-E EDID Example with Block Tag Extension (continued)**

Address Hex	Example Data Hex	Dec	Name of Block	Description	Remarks
0x84	0x47	71	CEA Data Block Collection Video Data Block	Start of data block collection. Includes Tag Code and length of following data block payload	0x47 = Video Block (code = 2) and seven bytes of data payload
0x85	0x85	133		1 <sup>st</sup> Short Video Descriptor	1920x1080i @ 59.94/60 Hz 16:9 Native Mode
0x86	0x02	2		2 <sup>nd</sup> Short Video Descriptor	720x480p 59.94/60 Hz 4:3
0x87	0x03	3		3 <sup>rd</sup> Short Video Descriptor	720x480p 59.94/60 Hz 16:9
0x88	0x04	4		4 <sup>th</sup> Short Video Descriptor	1280x720p 59.94/60 Hz 16:9
0x89	0x06	6		5 <sup>th</sup> Short Video Descriptor	720 (1440)x480i 59.94/60 Hz 4:3
0x8A	0x07	7		6 <sup>th</sup> Short Video Descriptor	720 (1440)x480i 59.94/60 Hz 16:9
0x8B	0x01	1		7 <sup>th</sup> Short Video Descriptor	640x480p 59.94/60 Hz 4:3
0x8C	0x23	35	Audio Data Block	Start of Audio Block	0x23 = Audio Block (code = 1) and three bytes of data payload.
0x8D	0x09	9		Audio Format	Code 1 = Linear PCM (IEC 60985-3 [13])
0x8E	0x07	7		Frequency	0x07 = 32 kHz, 44.1 kHz, 48 kHz
0x8F	0x07	7		Bit Rate	0x07 = 16 bit, 20 bit, 24 bit
0x90	0x83	131	Speaker Allocation Block	Start of Speaker Allocation	0x83 = Speaker Allocation Data Block (code = 4) and three bytes of data payload.
0x91	0x01	1		Speaker Designation	0x01 = FL / FR (2 Channel Stereo.)
0x92	0x00	0		Reserved	Always zero
0x93	0x00	0		Reserved	Always zero
0x94	0x65	101	Vendor Specific Data Block	Start of Vendor Specific Block	0x65 = Vendor Specific Block (code = 3) and five bytes of data payload.
0x95	0x03	3		24-bit IEEE Registration	HDMI Identifier = 0x000C03 (The big-endian HDMI-LLC's 24-bit OUI Registration Identifier 0x000C03 is placed into the EDID in little-endian order.)
0x96	0x0C	12			
0x97	0x00	0			
0x98	0x10	16		Components of Source Physical Address	Sink identifies location of source in signal path relative to root display as ABCD. Example shows input '1' of root display (A=1, B=0, C=0, D=0 or 0x1000).
0x99	0x00	0			

Table 99 CEA-861-E EDID Example with Block Tag Extension (continued)

Address Hex	Example Data Hex	Dec	Name of Block	Description	Remarks	
0x9A	0x01	1	Third Detailed Timing Descriptor	Pixel Clock	74.25 MHz	
0x9B	0x1D	29				
0x9C	0x00	0		H Active	1280 pixels	
0x9D	0x72	114		H Blanking	370 pixels	
0x9E	0x51	81		H Active: H Blanking		
0x9F	0xD0	208		V Active	720 lines	
0xA0	0x1E	30		V Blanking	30 lines	
0xA1	0x20	32		V Active: V Blanking		
0xA2	0x6E	110		H Sync Offset	110 pixels	
0xA3	0x28	40		H Sync Pulse Width	40 pixels	
0xA4	0x55	85		VS Offset: VS Pulse Width	Sync Offset = 5 lines, Sync width = 5 lines	
0xA5	0x00	0		HS Offset: HS Pulse Width: VS Offset: VS Pulse Width		
0xA6	0x20	32		H Image Size	800 mm (lower 8 bits)	
0xA7	0xC2	194		V Image Size	450 mm (lower 8 bits)	
0xA8	0x31	49		H&V Image Size	Upper 4 bits of H & V size	
0xA9	0x00	0		H Border	0 pixels	
0xAA	0x00	0		V Border	0 lines	
0xAB	0x1E	30		Flags	Non-interlaced, normal display no stereo, digital separate, H and V sync polarity is positive	
0xAC	0x8C	140	Fourth Detailed Timing Descriptor	Pixel Clock	27 MHz	
0xAD	0x0A	10				
0xAE	0xA0	160		H Active	1440 pixels	
0xAF	0x14	20		H Blanking	276 pixels	
0xB0	0x51	81		H Active: H Blanking		
0xB1	0xF0	240		V Active	240 lines	
0xB2	0x16	22		V Blanking	22 lines	
0xB3	0x00	0		V Active: V Blanking		
0xB4	0x26	38		H Sync Offset	38 pixels	
0xB5	0x7C	124		H Sync Pulse Width	124 pixels	
0xB6	0x43	67		VS Offset: VS Pulse Width	Sync Offset = 4 lines, Sync width = 3 lines	
0xB7	0x00	0		HS Offset: HS Pulse Width: VS Offset: VS Pulse Width		
0xB8	0x58	88		H Image Size	600 mm (lower 8 bits)	
0xB9	0xC2	194		V Image Size	450 mm (lower 8 bits)	
0xBA	0x21	33		H&V Image Size	Upper 4 bits of H & V size	
0xBB	0x00	0		H Border	0 lines	
0xBC	0x00	0		V Border	0 pixels	
0xBD	0x98	152		Flags	interlaced, normal display no stereo, digital separate, V. and H. sync polarity is negative,	

Table 99 CEA-861-E EDID Example with Block Tag Extension (continued)



Address Hex	Example Data Hex	Dec	Name of Block	Description	Remarks	
0xBE	0x8C	140	Fifth Detailed Timing Descriptor	Pixel Clock	27 MHz	
0xBF	0x0A	10				
0xC0	0xD0	208		H Active	720 pixels	
0xC1	0x8A	138		H Blanking	138 pixels	
0xC2	0x20	32		H Active: H Blanking		
0xC3	0xE0	224		V Active	480 lines	
0xC4	0x2D	45		V Blanking	45 lines	
0xC5	0x10	16		V Active: V Blanking		
0xC6	0x10	16		H Sync Offset	16 pixels	
0xC7	0x3E	62		H Sync Pulse Width	64 pixels	
0xC8	0x96	150		VS Offset: VS Pulse Width	Sync Offset= 9 lines, Sync width = 6	
0xC9	0x00	0		HS Offset: HS Pulse Width: VS Offset: VS Pulse Width		
0xCA	0x20	32		H Image Size	800 mm (lower 8 bits)	
0xCB	0xC2	194		V Image Size	450 mm (lower 8 bits)	
0xCC	0x31	49		H&V Image Size	Upper 4 bits of H&V size	
0xCD	0x00	0		H Border	0 lines	
0xCE	0x00	0		V Border	0 pixels	
0xCF	0x18	24		Flags	Non-interlaced, normal display no stereo, digital separate, V. and H. sync polarity is negative,	
0xD0	0x8C	140		Sixth Detailed Timing Descriptor	Pixel Clock	27 MHz
0xD1	0x0A	10				
0xD2	0xA0	160	H Active		1440 pixels	
0xD3	0x14	20	H Blanking		276 pixels	
0xD4	0x51	81	H Active: H Blanking			
0xD5	0xF0	240	V Active		240 lines	
0xD6	0x16	22	V Blanking		22 lines	
0xD7	0x00	0	V Active: V Blanking			
0xD8	0x26	38	H Sync Offset		38 pixels	
0xD9	0x7C	124	H Sync Pulse Width		124 pixels	
0xDA	0x43	67	VS Offset: VS Pulse Width		Sync Offset = 4 lines, Sync Width = 3 lines	
0xDB	0x00	0	HS Offset: HS Pulse Width: VS Offset: VS Pulse Width			
0xDC	0x20	32	H Image Size		800 mm (lower 8 bits)	
0xDD	0xC2	194	V Image Size		450 mm (lower 8 bits)	
0xDE	0x31	49	H&V Image Size		Upper 4 bits of H & V size	
0xDF	0x00	0	H Border		0 lines	
0xE0	0x00	0	V Border		0 pixels	
0xE1	0x98	152	Flags		interlaced, normal display no stereo, digital separate, V. and H. sync polarity is negative	

Table 99 CEA-861-E EDID Example with Block Tag Extension (continued)

Address Hex	Example Data Hex	Dec	Name of Block	Description	Remarks
0xE2	0x00	0	Padding Bytes		
0xE3	0x00	0			
0xE4	0x00	0			
0xE5	0x00	0			
0xE6	0x00	0			
0xE7	0x00	0			
0xE8	0x00	0			
0xE9	0x00	0			
0xEA	0x00	0			
0xEB	0x00	0			
0xEC	0x00	0			
0xED	0x00	0			
0xEE	0x00	0			
0xEF	0x00	0			
0xF0	0x00	0			
0xF1	0x00	0			
0xF2	0x00	0			
0xF3	0x00	0			
0xF4	0x00	0			
0xF5	0x00	0			
0xF6	0x00	0			
0xF7	0x00	0			
0xF8	0x00	0			
0xF9	0x00	0			
0xFA	0x00	0			
0xFB	0x00	0			
0xFC	0x00	0			
0xFD	0x00	0			
0xFE	0x00	0			
0xFF	0x7A	122	Checksum		Block 1 sum = 0xFF&(0x100- (0x1686&0xFF) = 0x7A

Table 99 CEA-861-E EDID Example with Block Tag Extension (continued)

**Annex E [Reserved for Future Use]**

## Annex F Guidance for Source & Sinks (Informative)

### F.1 Overview

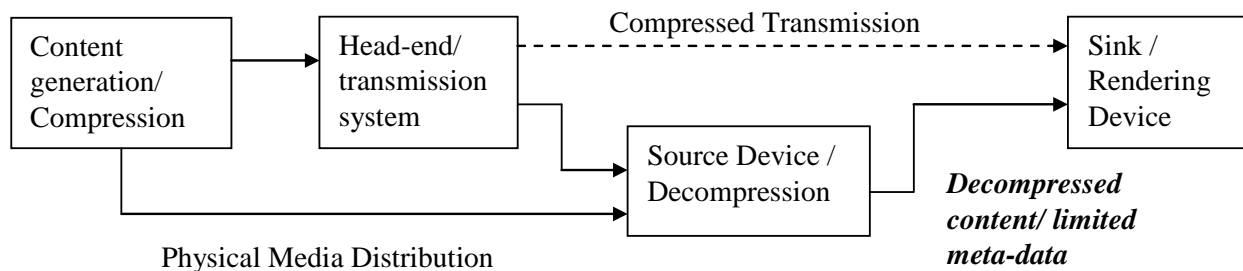
This Annex is intended to augment Section 7.2.3 “Source Guidance” and provide background and more detail to the recommendations therein.

The essence of that guidance is thus: video sources should provide a “pass-through” mode for content in its native format (avoiding scaling, frame rate converting interlacing, and deinterlacing), by using “pass-through”, it is more likely that only one (if any) format conversion occurs. When more than one format conversion occurs, generally more artifacts become evident in the content being presented. However, applying “pass through” is dependent on the use case in which content is being viewed.

Consistent application of the recommendations herein will help create to an ecosystem of CEA-861 conformant devices with the best possible out of box experience for consumers, regardless of brand name purchased.

### F.2 Background

The video processing chain from content production to presentation is envisioned as a set of black boxes that are integral to video distribution as shown in Figure 8. It does not show the audio processing chain.



**Figure 8 Video Processing Chain**

Examples of sources include CE devices (e.g., STBs, DVD players), IT devices (e.g., PCs), and convergent devices (e.g., PC/STB). Examples of sinks are DTVs, PC Monitors and possible convergent display devices (repeaters and splitters are not dealt with in this Annex).

The main interface of concern treated here is, the “Uncompressed data/Limited meta-data” link between the source and the sink.

Because the sink (in this case assumed to be a rendering device) is the last component in the device chain, it is incapable of enforcing any control over preceding devices with respect to video processing. Furthermore as there is no closed loop communication between sinks and sources, these devices can not negotiate as to where a certain function should or will be carried out (i.e. – scaling). To assure best performance of a complete system, a set of guidelines for default behavior, especially for sources, is needed. Two common usage scenarios exist that dictate different default behaviors.

1. Use cases where the source material’s video format is stable and unchanging for an extended period of time, (i.e. – playback of a movie).
2. Use cases where the source material’s video format is often changing (i.e. – channel surfing).

### F.3 Guidance for Sources

### F.3.1 Stable Video Format

Recommended default setting for use cases where a video format is expected to be stable: The source should transmit video in its native format directly to the sink without interlacing, deinterlacing, frame rate converting or scaling, provided that support for that format is indicated in the sink's EDID. Examples of this are illustrated in Figure 9 (b) and Figure 10 (d) & (f). Figure 9 (b) and Figure 10 (c) & (e) are examples of not passing through the native format, resulting in multiple conversions.

- a. Use cases that are covered by this recommendation include:
  - i. Playback from an optical disc player.<sup>12</sup>
  - ii. Playback from a Digital Video Camera (usually recorded at a single resolution).
  - iii. Presentation of an IT device.
  - iv. Playback of premium content from a STB.
- b. The reason this setting is recommended as default is that:
  - i. Sink (display) devices are often built with high quality signal processing (scaling, etc.) capabilities as a key differentiating feature. Although there are sources that deliver excellent scaling ability, most sources are optimized to deliver their key function (i.e. optical playback, interface to the managed network).
  - ii. Display devices are optimized to process signaling based on their own characteristics and properties. These properties may shift over the life of a display, temperature, and on-time, among other possibilities. Only the display itself is capable of monitoring and compensating for these shifts in parameters, nor is there a way for a sink to completely communicate such parameters to a source.
- c. Pass-through does not exclude the possibility of graphics overlay onto the original content (e.g. User Interface, Closed Captions, etc.).
- d. For IT sources that place the video content inside a fixed or resizable window, these rules do not necessarily apply.

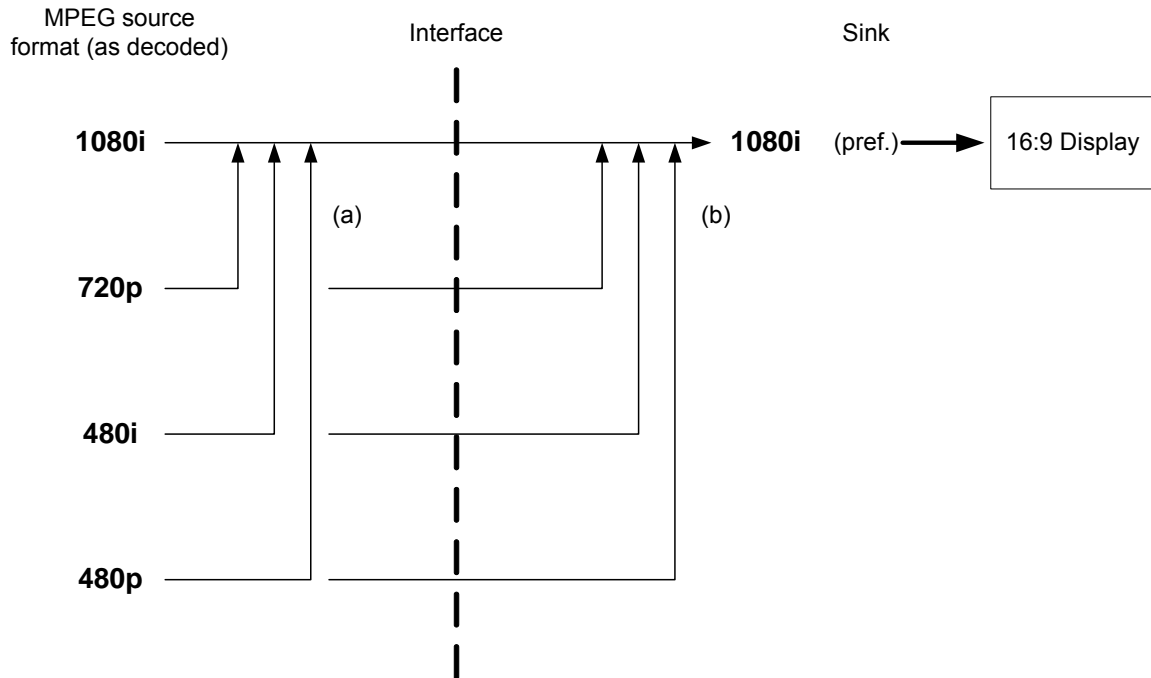
### F.3.2 Changing Video Format

Recommended default setting for use cases where a video format is expected to change often. The source should, by default, generate video in the Preferred Timing Format of the sink. Examples of this are shown in Figure 9 (a) and Figure 10 (c) & (e).

- a. Use cases that are covered by this recommendation include:
  - i. Playback from a STB where the user is channel surfing.
  - ii. Playback of broadcasts where the native resolution of the transmission stream is changing often (e.g. – program splicing, dynamic ad insertion).

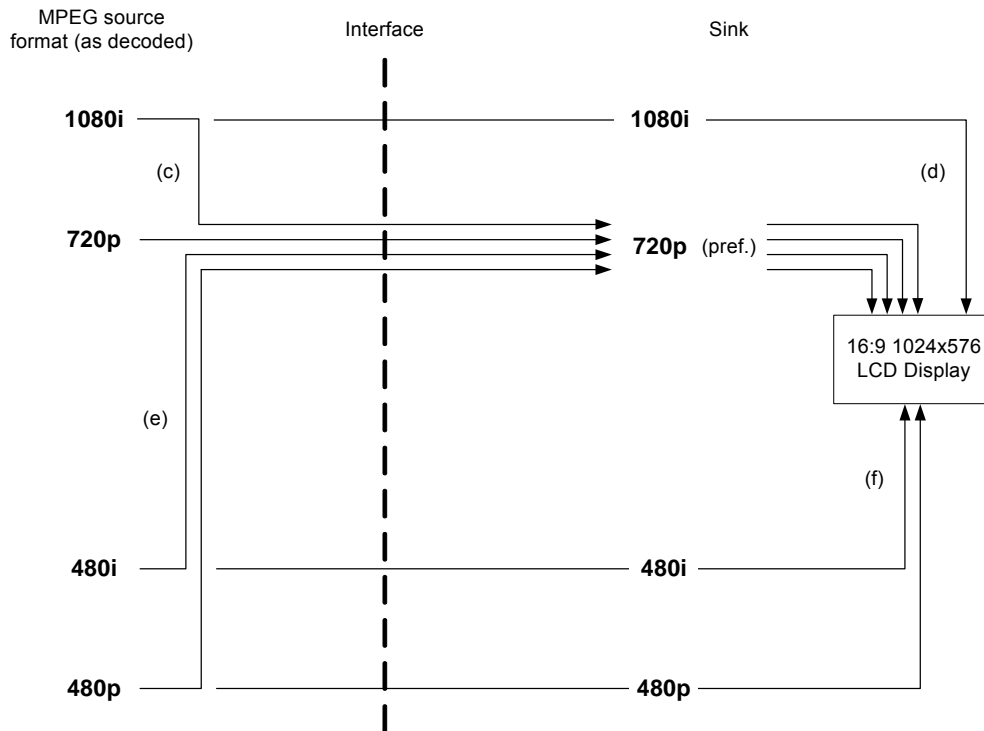
---

<sup>12</sup> In spite of the fact that previews, or other features may be in different formats than the full length feature, users will tolerate video muting when switching modes (i.e. – switching from menu to main feature). Viewing of full length features will be optimized.



**Figure 9 Example of Options for Format Conversion**

In the example shown in Figure 9, the sink indicates by its EDID data that it has a preferred format of 1080i, and that it can accept 1080i, 720p, 480i, or 480p. In the cases labeled (a), the conversion from the source material (which may be received and decoded as 1080i, 720p, 480i or 480p) to 1080i is happening in the source. In the other case, labeled (b), the source does no format conversion and delivers the as-decoded format across the interface. Conversion to 1080i is happening in the sink. If the sink is a multi-scan capable display and indicates the other formats are supported natively also, the best image presentation probably results if the conversion takes place in the sink.



**Figure 10 Multiple Conversions Example**

In the example in Figure 10 the sink can once again support 1080i, 720p, 480i, or 480p. In this case, the display is a 1024 by 576 LCD panel so none of these formats is native, and 720p is indicated as being “preferred.” The illustration shows conversions either taking place in the source, in the Display, or in both. Any conversion performed in the source is to 720p because 720p is indicated as the preferred format. This is a situation where at least one conversion takes place. In general, format conversions introduce errors and display artifacts. In the optimum system, at most one format conversion should be done between the MPEG-2 decoder and visual presentation. In Figure 10, MPEG-2 video in 1080i format is decoded, and can be converted (c) into the sink’s preferred 720p format. In this case, the Display re-converts 720p into its native 1024x576 LCD format. Alternatively, the 1080i video can be delivered unconverted across the interface (d) where the Display performs one conversion to its native format. The cases marked (e) are similar, in that two conversions result if the source re-formats into 720p before delivering the data across the interface. In the remaining cases the video is delivered in the same format as it was decoded, resulting in only one conversion. These cases illustrate that the best visual presentation may result when the source transports (passes through) the video to the sink in the same basic format as the decoded MPEG2 stream (assuming the ultimate source is MPEG2).

### F.3.3 Optional User Controlled Setting

Naturally, user accessible features to override default settings in sources are allowed. These types of user controls enable flexibility beyond the recommendations above. Such controls could enable better picture quality in the case of, for instance, use of an A/V receiver containing a high quality image processor. In such a case, it might be better to utilize the image processor of the A/V receiver, rather than allowing the display device to handle the video processing (the default recommendation).

### F.3.4 Non-Default Scenarios

When a source is incapable of supporting the recommendations in sections F.3.1 & F.3.2 above, then it should still follow the general recommendations for the appropriate use case, (i.e. following or not following the source material video format at its output). In such circumstances (i.e. native format of video

source, or preferred timing mode not supported) the source should generate an appropriate video format at its output, following the rules of precedence described in CEA-861-E (based on the ordering of video formats in EDID).

- a. The source should first attempt to convert the content to the video format described at the lowest address in the EDID.
- b. If the source cannot convert to the first format listed in the EDID, then it should transform the content to the video format described at the next lowest address. If the second format is not supported by the source, then the source should continue looking until it finds a supported format, with earlier formats being preferred over later ones. The source may also use other criteria to decide between formats listed in the EDID, such as the criteria listed in item c.
- c. If the source needs to transform the video format, it is recommended that transformations be made in the following order of precedence, in order to minimize video artifacts.
  - i. Image cropping where applicable. (Note: Content that requires a small fractional vertical “downscale”, like 1920x1088 @ 60Hz to 1920x1080 @ 60Hz, should simply be cropped. Cropping is commonly required when content originates from a video codec format (e.g. ISO/IEC 13818-2 [52]) encoded with a vertical size of 1088 lines. In this case, the source generally crops the bottom 8 lines of the originally coded content prior to outputting it in a 1080i/1080p format.)
  - ii. Horizontal upscale but no frame rate conversion (e.g. 1440x1080 @ 60Hz to 1920x1080 @ 60Hz or 704x480 @ 59.94Hz to 720x480 @ 59.94Hz)
  - iii. Vertical & horizontal upscale but no frame rate conversion (e.g. 720x576 @ 50Hz to 1280x720 @ 50Hz)
  - iv. Vertical & horizontal downscale but no frame rate conversion (e.g. 1280x720 @ 50Hz to 720x480 @ 50Hz)
  - v. Any frame rate conversion (e.g. 720x576 @ 50Hz to 720x480 @ 59.94Hz)
- d. The source should maintain video content in its original color space if the sink accepts that color space
  - i. If the sink accepts video content in  $Y_{C_B}C_R$  color space and the source receives or generates video content in the same  $Y_{C_B}C_R$  color space, the source should simply pass through the video content in that color space. If the source is additionally required to blend RGB encoded graphics planes (e.g. Closed Captions and Electronic Program Guide data) with the video content, it is preferable for the source to convert the graphics planes to the  $Y_{C_B}C_R$  color space of the video content prior to blending.
  - ii. If the sink only accepts video content in RGB color space the source should perform a  $Y_{C_B}C_R$  to RGB color space conversion after all image enhancement processes (e.g. scaling, interlacing, deinterlacing, noise reduction, frame rate conversion, etc.) have been applied.
- e. Sources capable of sending InfoFrames are required (per Section 6.4) to send accurate information regarding any video transformation done in the source, via an Auxiliary InfoFrame (AVI), provided the sink accepts InfoFrames.

### F.3.5 Errors Reading the EDID

- a. If an EDID read fails (i.e. incorrect checksum), the source should attempt to re-read the EDID.
- b. If after numerous attempts, the EDID read still fails, the source may utilize portions of the data that seem valid.
- c. If the EDID is not at all decipherable, the source should generate one of the default sink video formats defined in section 3.1 and shown in Table 1. The source should avoid transmitting audio across the interface. If the source can determine that the sink is CEA-861-E-compliant, then it may supply 720X480p or 720x576p since support for this format timing is required in all CEA-861-E conformant sinks. If the source can determine the preferred picture aspect ratio for that format, then it should use that picture aspect ratio. If the source cannot determine that the sink is CEA-861-E conformant, then it should output 640x480p if it is capable of that format. If it cannot output 640x480p, then it should output 720X480p or 720x576p.

### F.4 Guidance for Sinks



### F.4.1 Valid Read-Only EDID

- a. As required in Section 3.1 a sink indicates support for 640x480p video format in the EDID Detailed Timing Descriptors and/or the Short Video Descriptors.<sup>13</sup>
- b. If during the course of operation a sink modifies the contents of its EDID such that the video formats previously defined and read by source have changed, then the sink should indicate the change via a Hot Plug Event. (see Annex A.2.19)

### F.4.2 Ordering of the Video Formats in the EDID

Ordering of the video formats in EDID is critical to assure optimal performance of the complete system (assuming that sources follow the rules described in “Guidance for Sources”).

- a. The Preferred Timing Format, the video format described in the lowest EDID address, does not necessarily provide the optimal image on the display, especially if it is not the “native” resolution of the display (as shown in Fig 9). Delivering optimum display performance is a function of the display, the overall system, and the quality of the content.
- b. Designers should think carefully about the use cases described in the source guidance section of this annex, and order EDID so as to minimize the instances in which scaling might occur more than once.

The sequential order of video formats in EDID should be created according to the sink’s capabilities. The most preferred video format should be listed first and the next preferred format should be listed second, etc. Video formats not supported by the sink should not be listed in EDID. Consideration of methods sources might employ to determine an appropriate video format is advised.

### F.4.3 Video Information Code (VIC) Transition

After receiving an AVI Infoframe carrying a Video Identification Code (VIC) that is different than the preceding VIC, the sink should execute a mode switch as rapidly as possible, not checking the format of video itself, but assuming that the transmitted VIC is correct. This is recommended in order to minimize video muting between mode switches.

- a. Just prior to executing a mode switch, the sink should mute video such that any video artifacts that could potentially be displayed during the switch are masked from the user. The sink should un-mute video after the mode switch.

---

<sup>13</sup> Source devices might not read the Established Timings defined in Block 0, thus, support for 640x480p video format (defined in the Established Timings and no where else) might not be discovered by a source device.

**Annex G InfoPacket Framework (Informative)**

Previous versions of CEA-861 defined an InfoPacket data structure that could be used to bundle one or more InfoFrames together for transmission across an existing digital interface. The InfoPacket mechanism is not used in any current interface and is not expected to be used in any future interface and so has been deprecated.

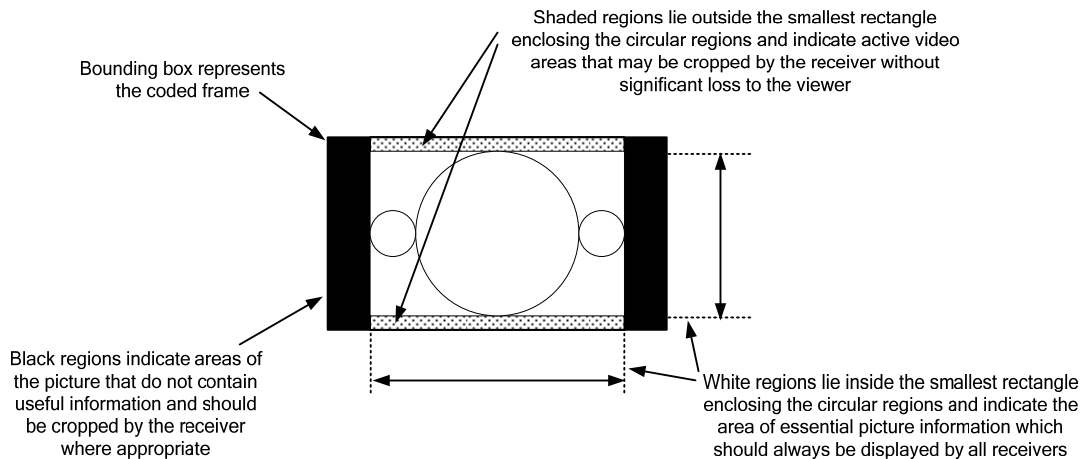
## Annex H Active Format Description (Informative)

This Annex describes the application of Active Format Description for video coded as constrained by the Advanced Television Systems Committee system (ATSC) and by the Digital Video Broadcast system (DVB).

### H.1 ATSC Active Format Description


This section is extracted from CEA-CEB16 Active Format Description (AFD) & Bar Data Recommended Practice [46].

Figure 11 illustrates the meanings of the bounding rectangles, gray areas, and white circles as used in Table 100. Table 100 illustrates the AFD codes expected to be used in North America (ATSC System). The meaning of each AFD value is coded frame context sensitive and each is defined in Table 100. The names used for ATSC systems are intentionally different from those used in Europe as the default actions are more specific based on the particular configuration of receiving and display equipment. CEA-CEB16 [46] contains more detailed characterizations of the frame contents as it adds bars that indicate black or gray generated by the receiver (either in the decoder or display). CEA-CEB-16 recommends receiver actions upon receipt of each code depending on video content which is transmitted to the CEA 861 interface and depending on characteristics of the display.



**Figure 11. Active Format Illustration (ATSC)**

#### Definitions:

- Coded Frame** A picture within a compressed video stream such as MPEG2 that is coded as a single frame or as two fields.
- Coded Frame Aspect Ratio** The picture aspect ratio associated with the coded frame of a compressed video stream such as MPEG2. It is either 4:3 or 16:9.
-  Indicates the portion of the active image which may be cropped for optimum display as appropriate to the aspect ratio of the display screen



Indicates a matte, typically black, which is transmitted as part of the MPEG-2 video coded frame to fill the area outside the active image

1  
2  
3  
4  
5  
6  
7  
8  
9  
10  
11  
12  
13  
14  
15  
16  
17  
18  
19  
20  
21  
22  
23  
24  
25  
26  
27  
28  
29  
30  
31  
32  
33  
34  
35  
36  
37  
38  
39  
40  
41  
42  
43  
44  
45  
46  
47  
48  
49  
50  
51  
52  
53  
54  
55  
56  
57  
58  
59  
60  
61  
62  
63  
64  
65  
66  
67  
68  
69  
70  
71  
72  
73  
74  
75  
76  
77  
78  
79  
80  
81  
82  
83  
84  
85  
86  
87  
88  
89  
90  
91  
92  
93  
94  
95  
96  
97  
98  
99  
100

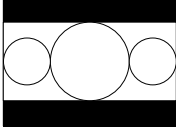
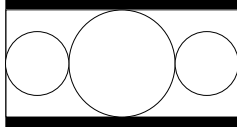
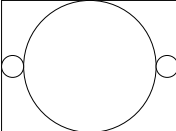
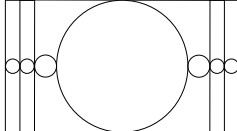
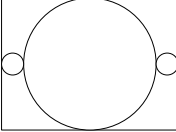
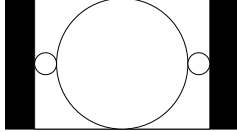
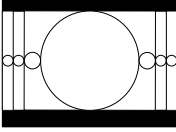
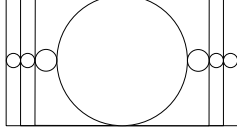
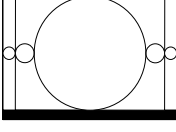
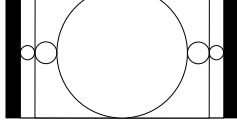
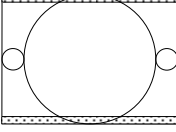
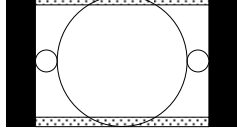
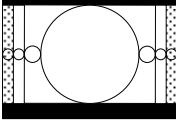
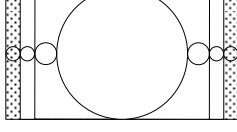
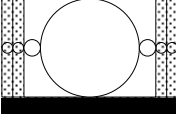
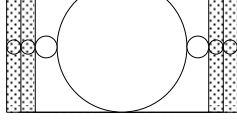
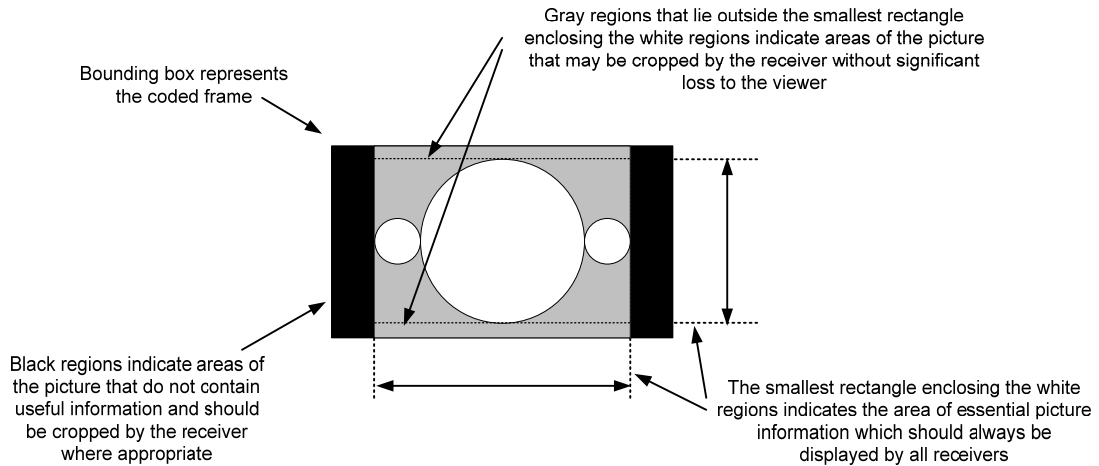
active_format	Description	
	4:3 coded frames	16:9 coded frames
'0000'	No AFD Specified	No AFD Specified
'0001'	Reserved	Reserved
'0010' – '0011'	Not documented for use in US	Not documented for use in US
'0100'	Greater than 16:9 letterbox image 	Greater than 16:9 letterbox image 
'0101' – '0111'	Reserved	Reserved
'1000'	4:3 full frame image 	16:9 full frame image 
'1001'	4:3 full frame image 	4:3 pillarbox image 
'1010'	16:9 letterbox image 	16:9 full frame image 
'1011'	14:9 letterbox image 	14:9 pillarbox image 
'1100'	Reserved	Reserved
'1101'	4:3 full frame image, alternative 14:9 center 	4:3 pillarbox image, alternative 14:9 center 
'1110'	16:9 letterbox image, alternative 14:9 center 	16:9 full frame image, alternative 14:9 center 
'1111'	16:9 letterbox image, alternative 4:3 center 	16:9 full frame image, alternative 4:3 center 

Table 100 Illustrated ATSC AFD Coding

## H.2 DVB Active Format Description

See Annex B of ETSI TS 101 154 [47] for implementation guidance in DVB systems, portions of which are replicated below for the convenience of the reader.

Figure 12 illustrates the meanings of the bounding rectangles, gray areas, and white circles as used in Table 101. Table 101 illustrates the AFD codes expected to be used in Europe (DVB System)



**Figure 12 Active Format Illustration (DVB)**

Definitions:

**Coded Frame** A picture within a compressed video stream such as MPEG2 that is coded as a single frame or as two fields.

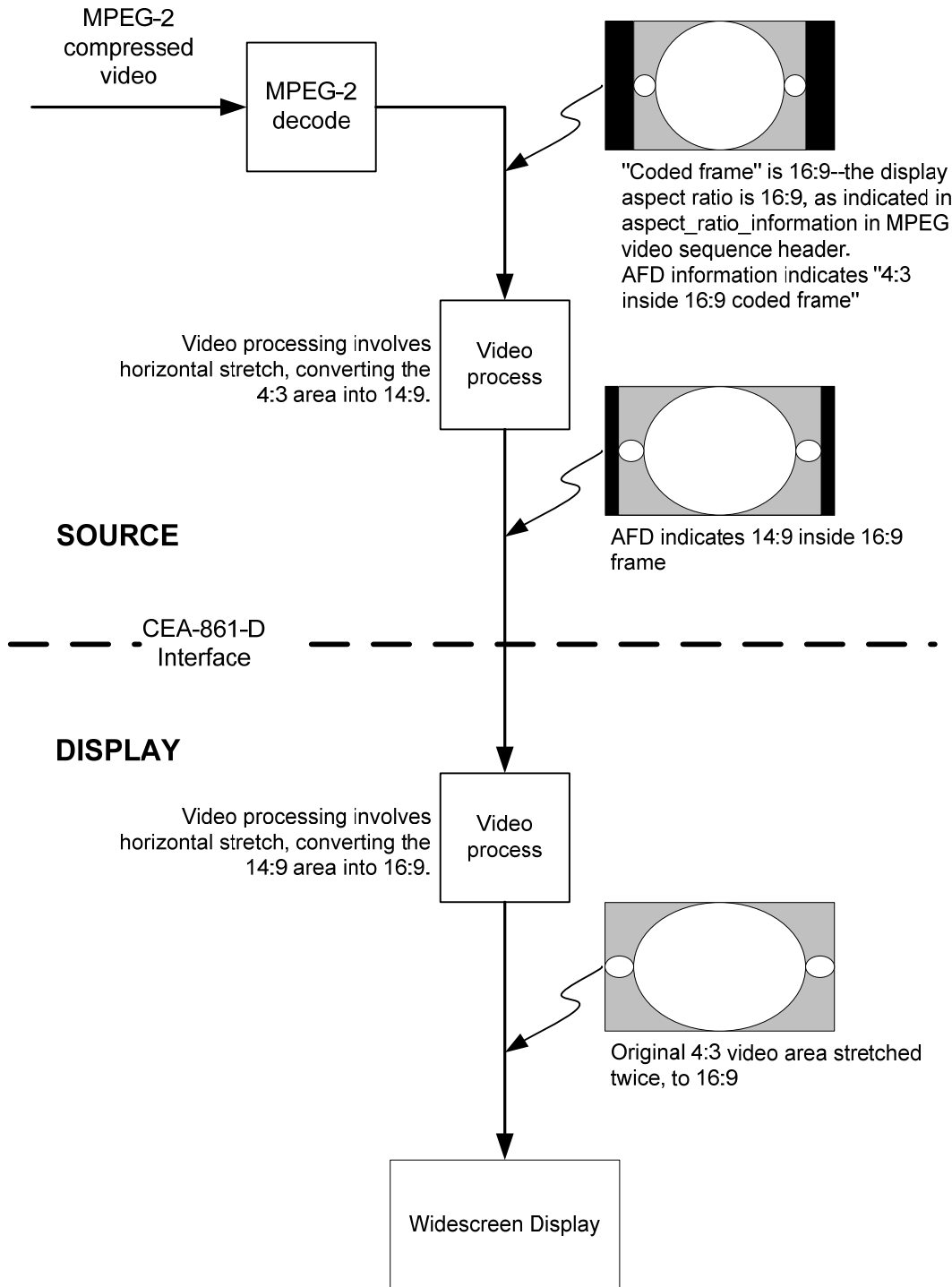
**Coded Frame Aspect Ratio** The picture aspect ratio associated with the coded frame of a compressed video stream such as MPEG2. It is either 4:3 or 16:9.

active_format		illustration of described format	
value	description	in 4:3 coded frame	in 16:9 coded frame
0000 - 0001	reserved		
0010	box 16:9 (top)		
0011	box 14:9 (top)		
0100	box > 16:9 (center)		
0101 - 0111	reserved		
1000	As the coded frame		
1001	4:3 (center)		
1010	16:9 (center)		
1011	14:9 (center)		
1100	reserved		
1101	4:3 (with shoot & protect 14:9 center)		
1110	16:9 (with shoot & protect 14:9 center)		
1111	16:9 (with shoot & protect 4:3 center)		

Table 101 Illustrated DVB AFD Coding

**Annex I Picture Aspect Ratio Conversion Example (Informative)**

Figure 13 illustrates a possible problem if both the source and display stretch the video horizontally to fit into a picture with a larger aspect ratio.



**Figure 13 Example of Problem Resulting from Double Stretch**



**Annex J [ Intentionally Omitted ]**

Copyright © 2008 Consumer Electronics Association

### Annex K Audio Speaker Placement & Channel Allocation Compatibility (Informative)

CEA-861-E does not exactly follow professional broadcast/production industry (i.e. MPGA, ITU, or SMPTE) speaker placement and audio channel allocation standards.

Table 102 compares the speaker placements between the SMPTE 320M [42] and CEA-861-E standards. There is general agreement between 5.1 channels – although the exact audio channel descriptions and abbreviations are slightly different. All other channels have no direct equivalents.

SMPTE 320M [42]		CEA-861	
Audio channel	Abbreviation	Abbreviation	Audio Channel
Left	L	FL	Front Left
Center	C	FC	Front Center
Right	R	FR	Front Right
Left surround	LS	RL	Rear Left
Right surround	RS	RR	Rear Right
Low-frequency effects	LFE	LFE	Low Frequency Effect
Mono surround	MS		
Mono surround at a --3 dB level	MS (-3dB)		
Left total	Lt		
Right total	Rt		
Stereo left	Lo		
Stereo right	Ro		
Monophonic	M		
Freely usable	F		
Unassigned / unused	U		
		FLC	Front Left Center
		FLW	Front Left Wide
		FLH	Front Left High
		FRC	Front Right Center
		FRW	Front Right Wide
		FRH	Front Right High
		FCH	Front Center High
		RC	Rear Center
		RLC	Rear Left Center
		RRC	Rear Right Center
		TC	Top Center

**Table 102 SMPTE/CEA Audio Channel Description & Abbreviation Comparison**

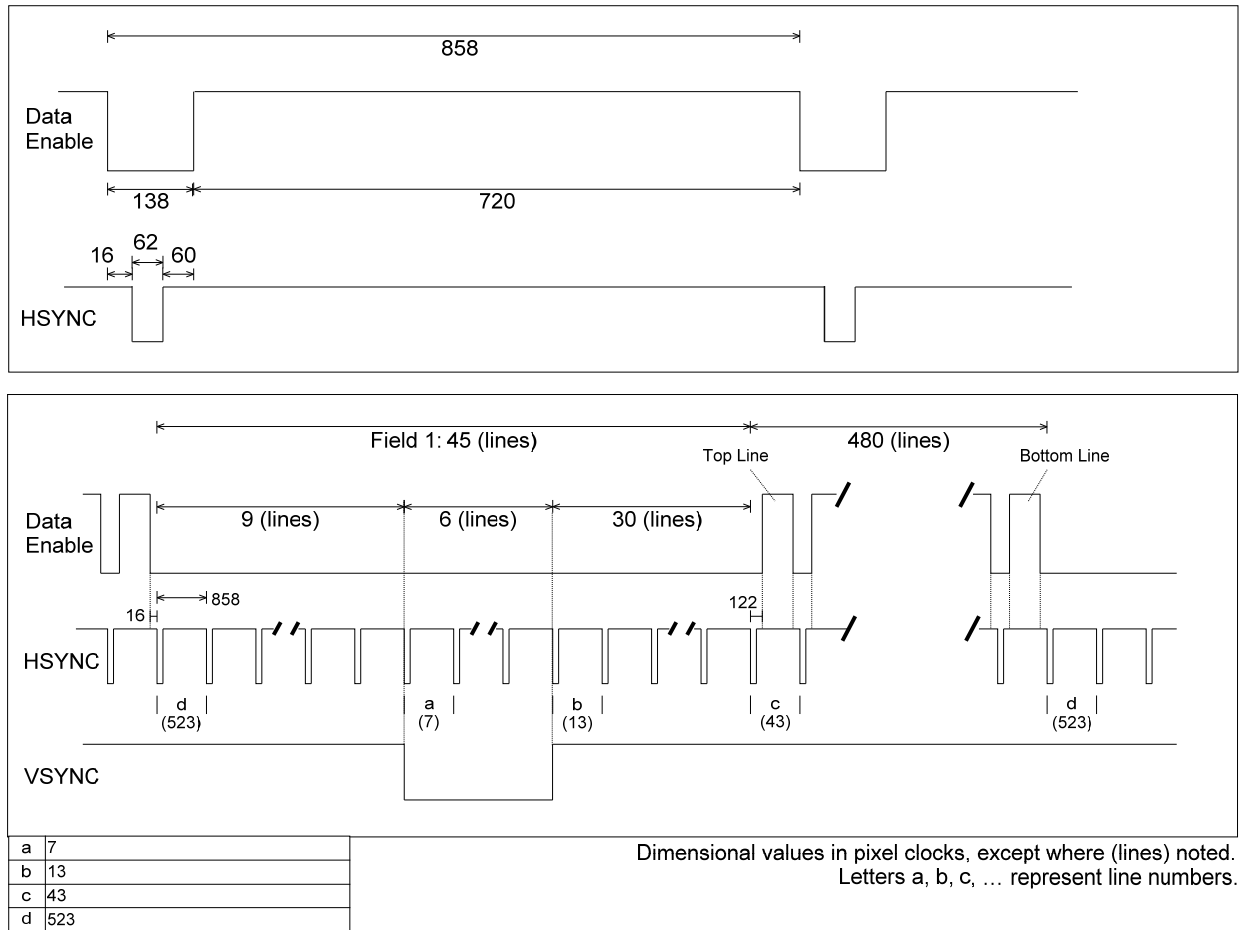
Table 103 compares the channel assignments between SMPTE 320M [42] and CEA-861-E standards. Here again, there is general agreement between the 5.1 channels except for the FC and LFE channels, which are swapped.

Channel	SMPTE 320M	CEA-861
1	L	FL
2	R	FR
3	C	LFE
4	LFE	FC
5	LS	RL or RC
6	RS	RR
7	Lt or Lo	RC, RLC, FLC, FCH, FLH, or FLW
8	Rt or Ro	RRC, FRC, TC, FRH, FRW, or FCH

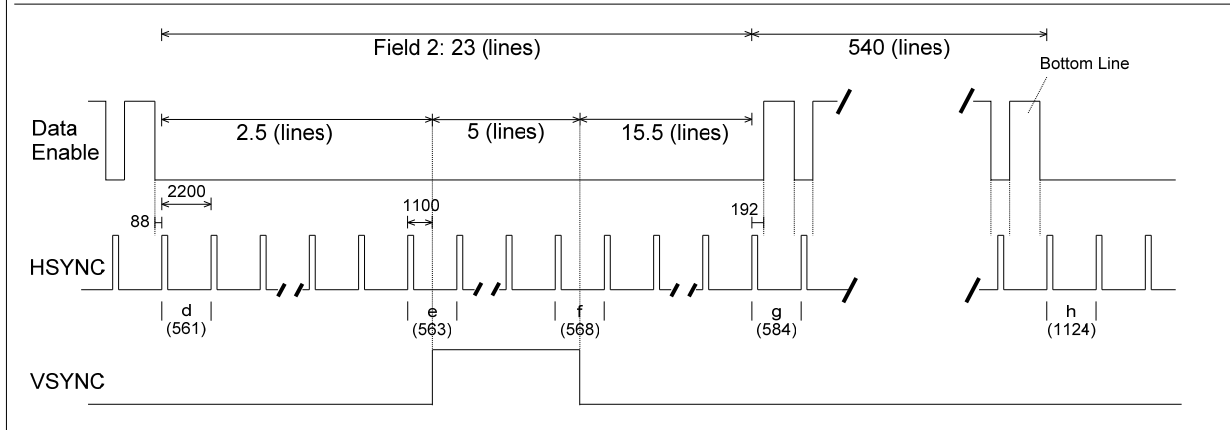
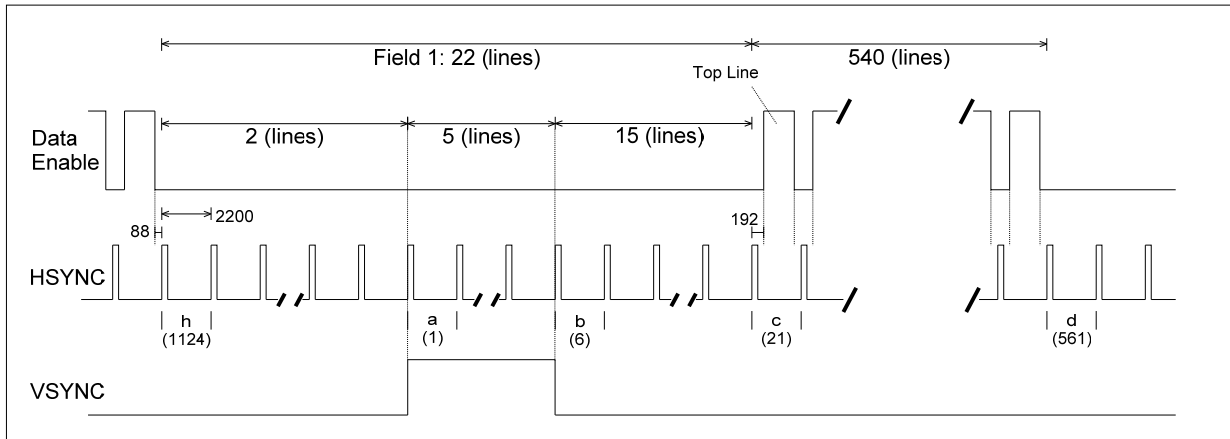
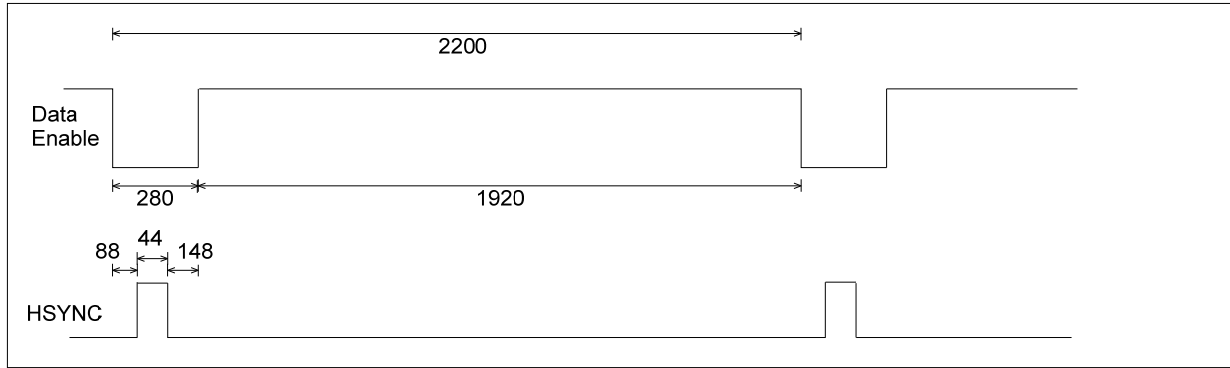
**Table 103 SMPTE/CEA Audio Channel Assignment Comparison**

**Annex L Video Timing Examples (Informative)**

This section gives three examples showing how tabular data from Table 2 and Table 3 is applied to the generalized waveforms of Figure 1, Figure 2, and Figure 5 for selected video timings. In these examples, all variables are replaced by specific values either taken directly from the tables or calculated using table values. Values for all of the line numbering variables are given in the table attached to the lower-left of each figure. These values also replace the respective variables in the figure.



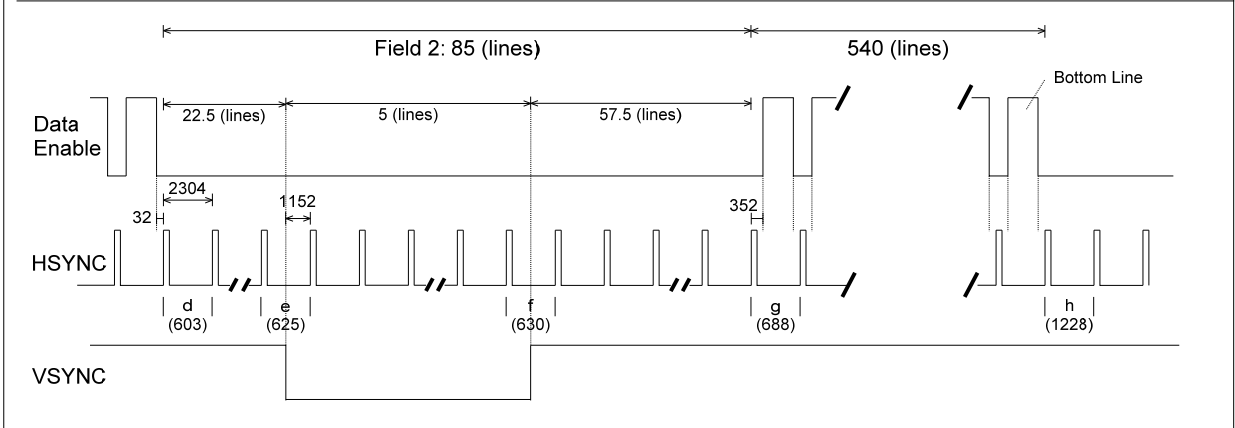
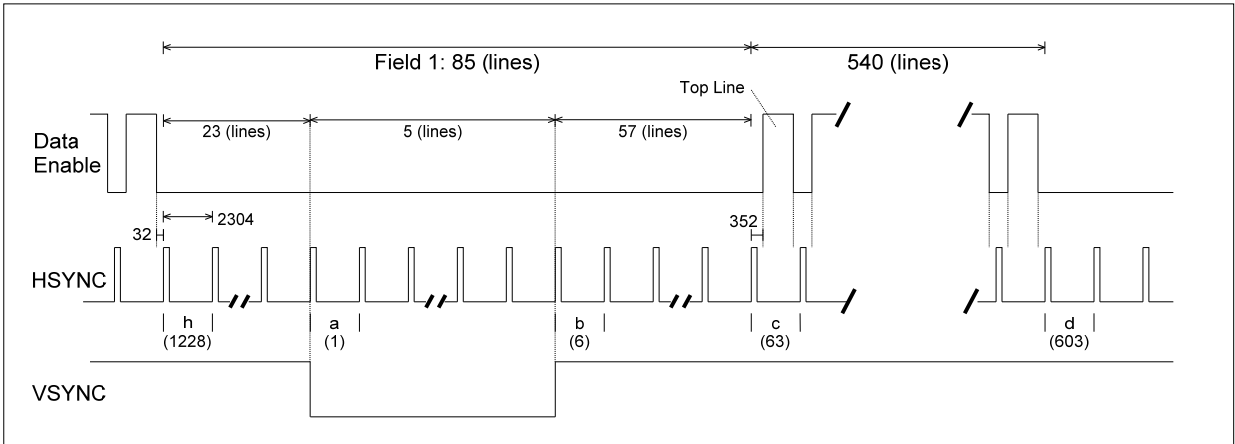
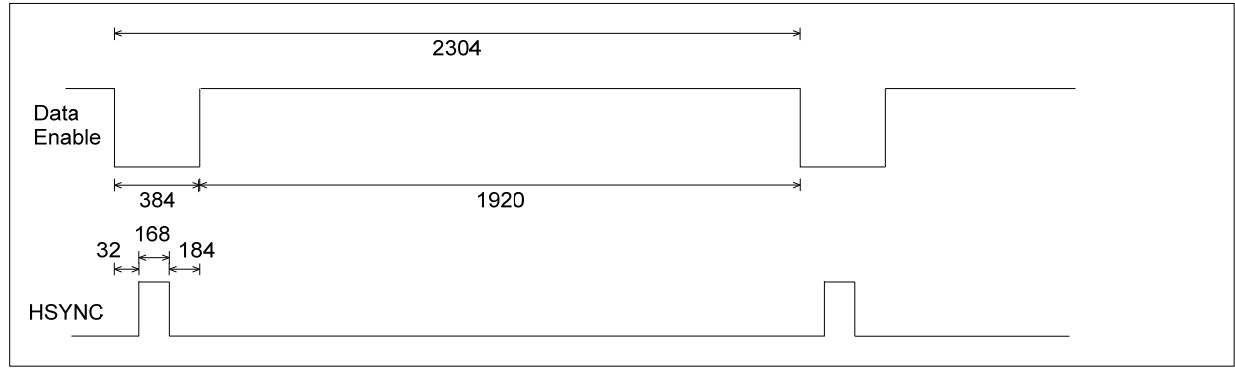
**Figure 14 General Progressive Example for Video ID Codes 2 & 3 (720x480p @ 60 Hz)**



a	1
b	6
c	21
d	561
e	563
f	568
g	584
h	1124

Dimensional values in pixel clocks, except where (lines) noted.  
Letters a, b, c, ... represent line numbers.

**Figure 15 General Interlace Example for Video ID Code 5 (1920x1080i @ 60 Hz)**



a	1
b	6
c	63
d	603
e	625
f	630
g	688
h	1228

Dimensional values in pixel clocks, except where (lines) noted.  
Letters a, b, c, ... represent line numbers.

Figure 16 Special Interlace Example for Video ID Code 39 (1920x1080i-1250 Vtotal @ 50 Hz)

## **CEA Document Improvement Proposal**

If in the review or use of this document, a potential change is made evident for safety, health or technical reasons, please email your reason/rationale for the recommended change to [standards@ce.org](mailto:standards@ce.org).

Consumer Electronics Association  
Technology & Standards Department  
1919 S Eads Street, Arlington, VA 22202  
FAX: (703) 907-7693 [standards@CE.org](mailto:standards@CE.org)

