

# CEA Standard

A DTV Profile for Uncompressed  
High Speed Digital Interfaces

CEA-861-C



August 2005

[www.CE.org](http://www.CE.org)

## NOTICE

CEA Standards, Bulletins and other technical publications are designed to serve the public interest through eliminating misunderstandings between manufacturers and purchasers, facilitating interchangeability and improvement of products, and assisting the purchaser in selecting and obtaining with minimum delay the proper product for his particular need. Existence of such Standards, Bulletins and other technical publications shall not in any respect preclude any member or nonmember of CEA from manufacturing or selling products not conforming to such Standards, Bulletins or other technical publications, nor shall the existence of such Standards, Bulletins and other technical publications preclude their voluntary use by those other than CEA members, whether the standard is to be used either domestically or internationally.

Standards, Bulletins and other technical publications are adopted by CEA in accordance with the American National Standards Institute (ANSI) patent policy. By such action, CEA does not assume any liability to any patent owner, nor does it assume any obligation whatever to parties adopting the Standard, Bulletin or other technical publication.

*Note: The user's attention is called to the possibility that compliance with this standard may require use of an invention covered by patent rights.*

*By publication of this standard, no position is taken with respect to the validity of this claim or of any patent rights in connection therewith. The patent holder has, however, filed a statement of willingness to grant a license under these rights on reasonable and nondiscriminatory terms and conditions to applicants desiring to obtain such a license. Details may be obtained from the publisher.*

This CEA Standard is considered to have International Standardization implication, but the International Electrotechnical Commission activity has not progressed to the point where a valid comparison between the CEA Standard and the IEC document can be made.

This Standard does not purport to address all safety problems associated with its use or all applicable regulatory requirements. It is the responsibility of the user of this Standard to establish appropriate safety and health practices and to determine the applicability of regulatory limitations before its use.

(From Project Number 20xx, formulated under the cognizance of the CEA R4.8 DTV Interface Subcommittee.)

Published by  
©CONSUMER ELECTRONICS ASSOCIATION 2002  
Technology & Standards Department  
2500 Wilson Boulevard  
Arlington, VA 22201

**PRICE: Please call Global Engineering Documents, USA and Canada (1-800-854-7179)  
International (303-397-7956), or  
<http://global.ihs.com>  
All rights reserved  
Printed in U.S.A.**

PLEASE!

DON'T VIOLATE  
THE  
LAW!

This document is copyrighted by CEA and may not be reproduced without permission.

Organizations may obtain permission to reproduce a limited number of copies through entering into a license agreement. For information, contact:

Global Engineering Documents  
15 Inverness Way East  
Englewood, CO 80112-5704 or call  
U.S.A. and Canada 1-800-854-7179, International (303) 397-7956  
See <http://global.ihs.com> or email [global@ihs.com](mailto:global@ihs.com)





## Contents

1 Scope.....	1
2 General.....	1
2.1 References .....	1
2.1.1 Normative References.....	1
2.1.1.1 Normative Reference List.....	1
2.1.1.2 Normative Reference Acquisition .....	2
2.1.2 Informative References .....	2
2.1.2.1 Informative Document List.....	2
2.1.2.2 Informative Document Acquisition .....	3
2.2 Definitions .....	4
2.3 Symbols and Abbreviations .....	6
2.4 Compliance Notation.....	7
3 Overview .....	7
3.1 General Requirements .....	7
4 Video Formats and Waveform Timings .....	9
4.1 Aspect Ratio.....	13
4.2 640x480p @ 59.94/60 Hz (Format 1).....	16
4.3 1280x720p @ 59.94/60 Hz (Format 4).....	17
4.4 1920x1080i @ 59.94/60 Hz (Format 5).....	18
4.5 720x480p @ 59.94/60 Hz (Formats 2 & 3).....	19
4.6 720(1440)x480i @ 59.94/60 Hz (Formats 6 & 7).....	20
4.7 1280x720p @ 50 Hz (Format 19).....	21
4.8 1920x1080i @ 50 Hz (Format 20).....	22
4.9 720x576p @ 50 Hz (Formats 17 & 18).....	23
4.10 720(1440)x576i @ 50 Hz (Formats 21 & 22).....	24
4.11 720(1440)x240p @ 59.94/60 Hz (Formats 8 & 9).....	25
4.12 (2880)x480i @ 59.94/60 Hz (Formats 10 & 11).....	26
4.13 (2880)x240p @ 59.94/60 Hz (Formats 12 & 13).....	27
4.14 1440x480p @ 59.94/60 Hz (Formats 14 & 15).....	29
4.15 1920x1080p @ 59.94/60 Hz (Format 16).....	30
4.16 720(1440)x288p @ 50 Hz (Formats 23 & 24).....	31
4.17 (2880)x576i @ 50 Hz (Formats 25 & 26).....	33
4.18 (2880)x288p @ 50 Hz (Formats 27 & 28).....	35
4.19 1440x576p @ 50 Hz (Formats 29 & 30).....	37
4.20 1920x1080p @ 50 Hz (Format 31).....	38
4.21 1920x1080p @ 23.98/24 Hz (Format 32).....	39
4.22 1920x1080p @ 25 Hz (Format 33).....	40
4.23 1920x1080p @ 29.97/30 Hz (Format 34).....	41
4.24 2880x480p @ 59.94/60 Hz (Formats 35 and 36).....	42
4.25 2880x576p @ 50 Hz (Formats 37 and 38).....	43
4.26 1920x1080i (1250 Total) @ 50 Hz (Format 39).....	44
4.27 1920x1080i @ 100 Hz (Format 40).....	45
4.28 1280x720p @ 100 Hz (Format 41).....	46
4.29 720x576p @ 100 Hz (Formats 42 and 43).....	47
4.30 720(1440)x576i @ 100 Hz (Formats 44 and 45).....	48
4.31 1920x1080i @ 119.88/120 Hz (Format 46).....	49
4.32 1280x720p @ 119.88/120 Hz (Format 47).....	50
4.33 720x480p @ 119.88/120 Hz (Formats 48 and 49).....	51
4.34 720(1440)x480i @ 119.88/120 Hz (Formats 50 and 51).....	52
4.35 720x576p @ 200 Hz (Formats 52 and 53).....	53

4.36 720(1440)x576i @ 200 Hz (Formats 54 and 55) .....	54
4.37 720x480p @ 239.76/240 Hz (Formats 56 and 57) .....	55
4.38 720(1440)x480i @ 239.76/240 Hz (Formats 58 and 59) .....	56
<b>5 Colorimetry and Quantization</b> .....	<b>56</b>
5.1 480p, 480i, 576p, 576i, 240p, and 288p .....	57
5.2 1080i, 1080p, and 720p .....	57
5.3 Recommendations on Conversions to/from Analog Signals .....	57
<b>6 Auxiliary Information Carried from Source to DTV Monitor</b> .....	<b>58</b>
6.1 Vendor Specific InfoFrames .....	59
6.2 Auxiliary Video Information (AVI) InfoFrame .....	59
6.3 Format of Version 1 AVI InfoFrame .....	60
6.4 Format of Version 2 AVI InfoFrame .....	61
6.5 Source Product Description (SPD) InfoFrame .....	67
6.6 Audio InfoFrame .....	69
6.6.1 Audio Identification Information .....	70
6.6.2 Speaker Mapping and Down-mix Information .....	71
6.7 MPEG Source InfoFrame .....	74
<b>7 EDID Data Structure</b> .....	<b>76</b>
7.1 Use of CEA Extensions .....	76
7.2 Describing Video Formats in EDID .....	77
7.2.1 Use of EDID Detailed Timing Descriptors .....	78
7.2.2 Order of Dual-Aspect Ratio Detailed Timing Descriptors .....	78
7.2.3 Source Device Guidance .....	78
7.3 CEA Extension Version 1 .....	78
7.4 CEA Extension Version 2 .....	79
7.5 CEA Extension Version 3 .....	80
7.5.1 Video Data Block .....	85
7.5.2 Audio Data Block .....	85
7.5.3 Speaker Allocation Data Block .....	86
7.5.4 Vendor Specific Block .....	87
<b>Annex A Example EDID and Detailed Timing Descriptors</b> .....	<b>88</b>
A.1 Background .....	88
A.2 EDID Tables .....	88
A.2.1 EDID Table Construction .....	88
A.2.2 Detailed Explanation of EDID Block Zero .....	89
A.2.3 Block Zero Header Section .....	89
A.2.4 Vendor / Product Identification .....	89
A.2.5 EDID Version .....	90
A.2.6 Basic Display Parameters and Features .....	91
A.2.7 Color Characteristics .....	93
A.2.8 Established Timings .....	94
A.2.9 Standard Timing ID #1 – 8 .....	95
A.2.10 Detailed Timing Descriptor Block .....	95
A.2.10.1 First Detailed Timing Descriptor .....	95
A.2.10.2 Second Detailed Timing Descriptor .....	96
A.2.10.3 First Monitor Descriptor (Monitor Name) .....	97
A.2.10.4 Second Monitor Descriptor (Monitor Range Limits) .....	98
A.2.11 Extension Flag and Checksum .....	99
A.2.11.1 Block One Details .....	100
A.2.12 Overview of Extensions .....	100
A.2.13 Block One CEA Extension Header .....	101
A.2.14 Third Detailed Timing Descriptor .....	103

A.2.15 Fourth Detailed Timing Descriptor .....	104
A.2.16 Descriptor Defined by Manufacturer .....	105
A.2.17 Monitor Serial Number .....	105
A.2.18 Residual Byte Padding and Check Sum .....	106
A.2.18.1 Hot Plugging Sequence .....	107
A.3 Complete Example EDID Table (Informative) .....	107
A.4 Example EDID Detailed Timing Descriptors .....	113
<b>Annex B Application to DVI 1.0 (Normative) .....</b>	<b>125</b>
B.1 Connector and Cable .....	125
B.2 Digital Content Protection .....	125
B.2.1 Additional Information .....	125
<b>Annex C Application to Open LDI (Normative) .....</b>	<b>126</b>
C.1 Open LDI Data and Control Signals .....	126
C.2 Non DC Balanced Mode .....	126
C.3 OpenLDI Cabling Information .....	126
C.3.1 Cable Length .....	127
C.3.2 Number of Signal Conductors .....	127
C.3.3 Wire Gauge .....	127
C.3.4 Conductor Resistance .....	127
C.3.5 Insulation .....	127
C.3.6 Shield Requirement .....	127
C.3.7 Single Twisted Pair Transmission Skew .....	127
C.3.8 Multiple Twisted Pair Transmission Skew .....	127
C.3.9 USB Cable Requirements .....	127
C.3.10 DDC Cable Requirements .....	127
<b>Annex D Application to HDMI (Informative) .....</b>	<b>128</b>
D.1 InfoPackets .....	128
D.2 EDID .....	128
D.3 Audio .....	128
D.4 HDCP .....	128
D.5 Additional Information .....	128
D.6 Example EDID Using Elements of CEA Block Tag Extension (Applicable to HDMI) .....	128
D.6.1 First Monitor Descriptor (Monitor Name) and Second Monitor Descriptor (Monitor Range Limits) .....	128
D.6.2 Extension Flag and Checksum .....	128
D.6.3 CEA Extension Header (Block 1) .....	128
D.6.4 CEA Data Block Collection .....	129
D.6.5 Video Data Block .....	129
D.6.6 CEA Audio Block .....	130
D.6.7 Speaker Allocation Block .....	130
D.6.8 Vendor Specific Block .....	131
D.6.9 Complete CEA-861-C Example with Block Tag Extension .....	132
<b>Annex E [Reserved for Future Use] .....</b>	<b>139</b>
<b>Annex F Format Conversion Examples (Informative) .....</b>	<b>140</b>
<b>Annex G InfoPacket Framework (Informative) .....</b>	<b>142</b>
<b>Annex H DVB Active Format Description (Informative) .....</b>	<b>143</b>
<b>Annex I Picture Aspect Ratio Conversion Example (Informative) .....</b>	<b>145</b>

Annex J Typical Audio Applications (Informative).....	146
---	-----

## Figures

Figure 1 Timing Parameters for 640x480p @ 59.94/60 Hz .....	16
Figure 2 Timing Parameters for 1280x720p @ 59.94/60 Hz .....	17
Figure 3 Timing Parameters for 1920x1080i @ 59.94/60 Hz.....	18
Figure 4 Timing Parameters for 720x480p @ 59.94/60 Hz .....	19
Figure 5 Timing Parameters for 720(1440)x480i @ 59.94/60 Hz .....	20
Figure 6 Timing Parameters for 1280x720p @ 50 Hz.....	21
Figure 7 Timing Parameters for 1920x1080i @ 50 Hz.....	22
Figure 8 Timing Parameters for 720x576p @ 50 Hz.....	23
Figure 9 Timing Parameters for 720(1440)x576i @ 50 Hz .....	24
Figure 10 Timing Parameters for 720(1440)x240p @ 59.94/60 Hz.....	25
Figure 11 Timing Parameters for (2880)x480i @ 59.94/60 Hz .....	27
Figure 12 Timing Parameters for (2880)x240p @ 59.94/60 Hz .....	28
Figure 13 Timing Parameters for 1440x480p @ 59.94/60 Hz .....	29
Figure 14 Timing Parameters for 1920x1080p @ 59.94/60 Hz .....	30
Figure 15 Timing Parameters for 720(1440)x288p @ 50 Hz .....	32
Figure 16 Timing Parameters for (2880)x576i @ 50 Hz .....	34
Figure 17 Timing Parameters for (2880)x288p @ 50 Hz .....	36
Figure 18 Timing Parameters for 1440x576p @ 50 Hz.....	37
Figure 19 Timing Parameters for 1920x1080p @ 50 Hz .....	38
Figure 20 Timing Parameters for 1920x1080p @ 23.98/24 Hz .....	39
Figure 21 Timing Parameters for 1920x1080p @ 25 Hz .....	40
Figure 22 Timing Parameters for 1920x1080p @ 29.97/30 Hz .....	41
Figure 23 Timing Parameters for 2880x480p @ 59.94/60 Hz .....	42
Figure 24 Timing Parameters for 2880x576p @ 50 Hz.....	43
Figure 25 Timing Parameters for 1920x1080i (1250 Total) @ 50 Hz.....	44
Figure 26 Timing Parameters for 1920x1080i @ 100 Hz.....	45
Figure 27 Timing Parameters for 1280x720p @ 100 Hz .....	46
Figure 28 Timing Parameters for 720x576p @ 100 Hz.....	47
Figure 29 Timing Parameters for 720(1440)x576 @ 100 Hz .....	48
Figure 30 Timing Parameters for 1920x1080i @ 119.88/120 Hz.....	49
Figure 31 Timing Parameters for 1280x720p @ 119.88/120 Hz .....	50
Figure 32 Timing Parameters for 720x480p @ 119.88/120 Hz .....	51
Figure 33 Timing Parameters for 720(1440)x480i @ 119.88/120 Hz .....	52
Figure 34 Timing Parameters for 720x576p @ 200 Hz.....	53
Figure 35 Timing Parameters for 720(1440)x576i @ 200 Hz .....	54
Figure 36 Timing Parameters for 720x480p @ 239.76/240 Hz .....	55
Figure 37 Timing Parameters for 720(1440)x480i @ 239.76/240 Hz .....	56
Figure 38 Speaker Placement .....	71
Figure 39 OpenLDI Synchronization .....	126
Figure 40 Example of Options for Format Conversion .....	140
Figure 41 Multiple Conversions Example.....	141
Figure 42 Active Format Illustration.....	143
Figure 43 Example of Problem Resulting from Double Stretch .....	145

## Tables

Table 1 Video Format Timings—Support Requirements and Recommendations .....	9
Table 2 Video Format Timings—Detailed Timing Information .....	11
Table 3 Video Formats—Video ID Code and Aspect Ratios .....	14
Table 4 List of InfoFrame Type Codes .....	58

Table 5 Vendor Specific InfoFrame .....	59
Table 6 Auxiliary Video Information InfoFrame Format (Version 1) .....	61
Table 7 Auxiliary Video Information (AVI) InfoFrame Format (Version 2) .....	62
Table 8 AVI InfoFrame Data Byte 1 .....	62
Table 9 AVI InfoFrame Data Byte 2 .....	63
Table 10 Common Active Formats .....	64
Table 11 AVI InfoFrame Data Byte 3 .....	64
Table 12 AVI InfoFrame Pixel Repetition Field, Data Byte 5 .....	65
Table 13 Valid Pixel Repeat Values for Each Video Format Timing .....	66
Table 14 Source Product Description InfoFrame Format .....	68
Table 15 Source Product Description InfoFrame Data Byte 25 .....	69
Table 16 Audio InfoFrame Format .....	70
Table 17 Audio InfoFrame Data Byte 1 .....	70
Table 18 Audio InfoFrame Data Byte 2 .....	71
Table 19 Speaker Placement .....	72
Table 20 Audio InfoFrame Data Byte 4 .....	73
Table 21 Audio InfoFrame Data Byte 5, Level Shift Value .....	74
Table 22 Audio InfoFrame Data Byte 5, Down-mix Inhibit Flag .....	74
Table 23 MPEG Source InfoFrame format .....	75
Table 24 MPEG Source InfoFrame Data Byte 5 .....	76
Table 25 CEA Extension Version 1 .....	79
Table 26 CEA Extension Version 2 .....	80
Table 27 CEA Extension Version 3 .....	82
Table 28 General Format of "CEA Data Block Collection" .....	83
Table 29 General Tag Format .....	83
Table 30 CEA Data Block Tag Codes .....	84
Table 31 Extended Tag Format (2 <sup>nd</sup> Byte of Data Block) .....	84
Table 32 CEA Data Block Tag Codes .....	84
Table 33 Short Video Descriptor .....	85
Table 34 CEA Short Audio Descriptor for Audio Code = 1 (LPCM) .....	85
Table 35 CEA Short Audio Descriptor for Audio Codes 2 to 8 .....	86
Table 36 CEA Short Audio Descriptor for Audio Codes 9 to 15 .....	86
Table 37 Audio Format Codes .....	86
Table 38 Speaker Allocation Data Block Payload .....	87
Table 39 Standard Data Lengths .....	89
Table 40 Block Zero Header .....	89
Table 41 Vendor / Product Identification .....	90
Table 42 Version of EDID .....	91
Table 43 Example 15h, 16h EDID Screen Size Data and Certain Display Categories .....	91
Table 44 Feature Support Detail .....	92
Table 45 Basic Display Parameters and Features Block .....	93
Table 46 Binary to Decimal Conversion Example .....	93
Table 47 Color Characteristics Block .....	94
Table 48 Established Timings Block .....	94
Table 49 Standard Timing ID Block .....	95
Table 50 First Detailed Timing Descriptor Block (1920x1080i Example) .....	96
Table 51 Second Detailed Timing Descriptor Block (720x480p, 4:3 Example) .....	97
Table 52 First Monitor Descriptor Block (Monitor Name) .....	98
Table 53 Second Monitor Descriptor Block (Monitor Range Limits) .....	99
Table 54 Extension Flag Block .....	100
Table 55 EDID Extension Tags .....	100
Table 56 CEA Extension Version 1 .....	101
Table 57 Block One CEA Extension Header .....	102
Table 58 Third Detailed Timing Descriptor Block (720p, 16:9 Example) .....	103
Table 59 Fourth Detailed Timing Descriptor Block (480i, 4:3 Example) .....	104
Table 60 Descriptor Defined by Manufacturer Block .....	105

Table 61 Monitor Serial Number Block .....	105
Table 62 Residual Byte Stuffing and Check Sum Block .....	106
Table 63 Complete EDID Example .....	107
Table 64 Example EDID Detailed Timing Descriptor for 1280x720p (60 Hz, 16:9).....	113
Table 65 Example EDID Detailed Timing Descriptor for 1920x1080i (60 Hz, 16:9).....	114
Table 66 Example EDID Detailed Timing Descriptor for 720x480p (59.94Hz, 4:3).....	115
Table 67 Example EDID Detailed Timing Descriptor for 720x480p (59.94Hz, 16:9).....	116
Table 68 Example EDID Detailed Timing Descriptor for 720x480i (59.94Hz, 4:3).....	117
Table 69 Example EDID Detailed Timing Descriptor for 720x480i (59.94Hz, 16:9).....	118
Table 70 Example EDID Detailed Timing Descriptor for 1280x720p (50 Hz, 16:9).....	119
Table 71 Example EDID Detailed Timing Descriptor for 1920x1080i (50 Hz, 16:9).....	120
Table 72 Example EDID Detailed Timing Descriptor for 720x576p (50 Hz, 4:3).....	121
Table 73 Example EDID Detailed Timing Descriptor for 720x576p (50 Hz, 16:9).....	122
Table 74 Example EDID Detailed Timing Descriptor for 720x576i (50 Hz, 4:3).....	123
Table 75 Example EDID Detailed Timing Descriptor for 720x576i (50 Hz, 16:9).....	124
Table 76 OpenLDI Control Signals .....	126
Table 77 CEA Extension Header (Block 1) .....	129
Table 78 Video Data Block .....	130
Table 79 Audio Data Block .....	130
Table 80 Speaker Data Block.....	131
Table 81 Vendor Specific Data Block.....	131
Table 82 CEA-861-C EDID Example with Block Tag Extension.....	138
Table 83 AFD Coding .....	144
Table 84 Some Typical Audio Applications.....	146

## FOREWORD

This standard was developed under the auspices of the CEA R4.8 DTV Interface Subcommittee.

CEA-861-C supersedes CEA-861-B and EIA/CEA-861-B.

NOTE—In 2003, CEA redesignated EIA/CEA standards and bulletins, and those EIA standards under CEA auspices, as CEA standards or bulletins, respectively. Please see <http://global.ihs.com> for the most recent designation.



CEA-861-C

(This page intentionally left blank.)

## A DTV Profile for Uncompressed High Speed Digital Interfaces

### 1 Scope

CEA-861-C establishes protocols, requirements, and recommendations for the utilization of uncompressed digital interfaces with consumer electronics devices such as digital televisions (DTVs), digital cable, satellite or terrestrial set-top boxes, and related peripheral devices including, but not limited to DVD players/recorders, and other related source or sink devices.

Specific, applicable physical interfaces are based on the DVI 1.0, Open LDI, and HDMI specifications. Protocols, requirements, and recommendations that are defined include video formats and waveforms; colorimetry and quantization; transport of compressed and uncompressed, as well as LPCM, audio; carriage of auxiliary data; and implementations of the *VESA Enhanced Extended Display Identification Data Standard (E-EDID)*, which is used by sink devices to declare display capabilities and characteristics.

CEA-861 adopters are strongly encouraged to implement HDCP content protection defined by the Digital Content Protection (DCP, LLC) [4] method, in order to be compatible with digital cable set top boxes as authorized by 47 CFR Parts 76.602 and 76.640. HDCP adoption in a CEA-861-C-enabled DTV also permits viewing of high-value content that may be available from other video sources in a home network.

### 2 General

#### 2.1 References

This standard includes mechanisms that allow a digital video source (such as a cable, satellite or terrestrial set-top box, digital VCR, or DVD player) to supply displayable, baseband, digital video to HDTV Monitors and EDTV Monitors (DTV Monitors), as defined in *CEA Expands Definitions for Digital Television Products* [16].

##### 2.1.1 Normative References

The following standards contain provisions that, through reference in this text, constitute normative provisions of this standard. At the time of publication, the editions indicated were valid. All standards are subject to revision, and parties to agreements based on this standard are encouraged to investigate the possibility of applying the most recent editions of the standards listed in Sec. 2.1.1.1. If the referenced standard is dated, the reader is advised to use the version specified.

##### 2.1.1.1 Normative Reference List<sup>1</sup>

1. ANSI/SMPTE 170M-1999 Composite Analog Video Signal—NTSC for Studio Applications, 1999
2. DDWG, "Digital Visual Interface," Revision 1.0, April 2, 1999
3. ETSI TR 101 154 v1.4.1, *Digital Video Broadcasting (DVB); Implementation Guidelines for the Use of MPEG-2 Systems, Video and Audio in Satellite, Cable and Terrestrial Broadcasting Applications (Annex B)*, July 2000
4. DCP, L.L.C. HDCP Specification revision 1.1, June 09, 2003
5. ITU-R BT.601-5, Studio Encoding parameters of digital television for standard 4:3 and wide-screen 16:9 aspect ratios, 1995
6. ITU-R BT.709-5, Parameter Values for the HDTV standards for production and International Programme Exchange, 2002
7. Open LVDS Display Interface (Open LDI) Specification," Version 0.95, May 13, 1999
8. VESA E-EDID™ Standard, *VESA Enhanced Extended Display Identification Data Standard*, Release A, Revision 1, February 9, 2000
9. VESA E-DDC™ Standard, *VESA Enhanced Display Data Channel Standard*, Version 1.1, March 24, 2004
10. VESA Monitor Timing Specifications, *VESA and Industry Standards and Guidelines for Computer Display Monitor Timing (DMT)*, Version 1.0, Revision 10, Adoption Date: October 29, 2004

<sup>1</sup> In some instances, only specified sections of a standard may be normative. References listed below shall take precedence over references within these listed references.

CEA-861-C

### 2.1.1.2 Normative Reference Acquisition

#### ANSI/CEA Standards

- Global Engineering Documents, World Headquarters, 15 Inverness Way East, Englewood, CO USA 80112-5776; Phone 800-854-7179; Fax 303-397-2740  
URL: <http://global.ihs.com> ; Email [global@ihs.com](mailto:global@ihs.com)
- ANSI/SMPTE Standards Society of Motion Picture and Television Engineers, 595 W. Hartsdale Avenue, White Plains, NY 10607-1824, Phone 914-761-1100, Fax 914-761-3115 URL:  
<http://www.smppte.org>

#### DDWG

- Contact Digital Display Working Group (DDWG); Attn: DDWG Administrator; M/S JF3-361; 2111 NE 25th Avenue, Hillsboro, OR 97124-5961, USA; Fax: (503)264-5959; Email: [ddwg.if@intel.com](mailto:ddwg.if@intel.com) ; URL: <http://www.ddwg.org>

#### HDCP

- Contact Digital Content Protection, L.L.C., c/o Intel Corporation, Stephen Balogh, JF2-55; 2111 NE 25th Ave; Hillsboro, OR 97124; Email: [info@digital-cp.com](mailto:info@digital-cp.com) ; URL: [http://www.digital-cp.com/Digital Content Protection, LLC](http://www.digital-cp.com/DigitalContentProtection,LLC); EMail: [info@digital-cp.com](mailto:info@digital-cp.com) ; URL: <http://www.digital-cp.com>

#### ITU Standards

- International Telecommunications Union, Place des Nations, CH-1211 Geneva 20, Switzerland; Phone +41 22 730 5111; Fax +41 22 733 7256:  
URL [http:// www.itu.int/publications/default.aspx](http://www.itu.int/publications/default.aspx) ; Email: [itumail@itu.int](mailto:itumail@itu.int)

#### OpenLDI

- Contact National Semiconductor: <http://www.national.com/appinfo/fpd/>

#### VESA Standards

- Contact Video Electronics Standards Association, 860 Hillview Court, Suite 150, Milpitas, CA 95035, USA; telephone: (408) 957-9270 ; URL <http://www.vesa.org>

### 2.1.2 Informative References

The following documents contain information that is useful in understanding this standard. Some of these documents are drafts of standards that may become normative references in a future release of this standard.

#### 2.1.2.1 Informative Document List

11. ANSI/SMPTE Standard 253M (1998), Standard for Television—Three-Channel RGB Analog Video Interface
12. SMPTE Standard 274M (2003), SMPTE Standard for Television—1920X1080 Image Sample Structure, Digital Representation and Digital Timing Reference Sequences Multiple-Picture Rates
13. ANSI/SMPTE Standard 293M (2003), SMPTE Standard for Television—720X483 Active Line at 59.94 Hz Progressive Scan Production—Digital Representation
14. ANSI/SMPTE 296M (2001), Standard for Television—1280 X720 Scanning, Analog and Digital Representation and Analog Interface
15. ATSC Standard A/52, Digital Audio Compression (AC-3) Standard, December 20, 1995
16. CEA Press Release; *CEA Expands Definitions for Digital Television Products*; August 31, 2000
17. DVD Forum, *DVD Specifications for Read-Only Disc, Part3, Video Specifications*, Version 1.0, August 1996
18. DVD Forum, *DVD Specifications for Read-Only Disc, Part 4, Audio Specifications*, Version 1.0
19. CEA-770.2-C, *Standard Definition TV Analog Component Video Interface*, August 2001
20. CEA-770.3-C, *High Definition TV Analog Component Video Interface*, August 2001
21. CEA-849-A, *Application profiles for EIA-775A compliant DTVs*, 2001

22. ETSI TR 101 154 v1.4.1, *Digital Video Broadcasting (DVB); Implementation Guidelines for the Use of MPEG-2 Systems, Video and Audio in Satellite, Cable and Terrestrial Broadcasting Applications*, July 2000
23. IEC61937 *Digital Audio - Interface for non-linear PCM encoded audio bitstreams applying IEC60958*, First Edition, 2000
24. IEC60958-1 *Digital Audio Interface - Part 1: General*, First Edition, 1999
25. IEC60958-3 *Digital Audio Interface - Part 3: Consumer Applications*, First Edition, 1999
26. ISO/IEC 11172-3:1993, *Information Technology - Coding of moving pictures and associated audio for digital storage media at up to about 1.5 Mbit/sec*, Part 3: Audio, 1993
27. ISO/IEC 13818-3, *Information Technology - Generic coding of moving pictures and associated audio information*, Part 3: Audio, Second Edition, 1998-04-15
28. ISO/IEC 14496-3, *Information Technology - Coding of audio-visual objects*, Part 3: Audio, Amendment 1: Audio Extensions, 2000-09-15
29. ITU-R BT.1358, *Studio Parameters of 625 and 525 Line Progressive Scan Television Systems*, 1998.
30. ITU-R BT.470-6, *Conventional Television Systems*, 1998
31. ITU-R BT.656-4, *Interfaces for Digital Component Video Signals in 525-line and 625-line Television Systems Operating at the 4:2:2 Level of Recommendation*, 1998
32. ITU-R BT.711-1, *Synchronizing Reference Signals for the Component Digital Studio*, 1992.
33. VESA DDC/CI Standard, *VESA Display Data Channel Command Interface (DDC/CI) Standard*, Version 1.1, October 29, 2004
34. VESA DI-EXT, *Display Information Extension Block (DI-EXT™) for E-EDID*, Release A, August 21, 2001
35. VESA E-EDID™ Implementation Guide, *VESA Enhanced Extended Display Identification Data—Implementation Guide*, Version 1.0, June 4, 2001
36. VESA GTF Standard, *VESA Generalized Timing Formula Standard*, Version 1.1, September 2, 1999.
37. VESA Coordinated Video Timings (CVT), Version 1.1, September 10, 2003
38. Super Audio CD System Description
39. High-Definition Multimedia Interface Specification, Version 1.1, May 20, 2004
40. CEA-608-C, Line 21 Data Service, August 2005
41. CEA-708-B, Digital Television (DTV) Closed Captioning, December, 1999

#### 2.1.2.2 Informative Document Acquisition

##### CEA Standards

- Global Engineering Documents, World Headquarters, 15 Inverness Way East, Englewood, CO USA 80112-5776; Phone 800-854-7179; Fax 303-397-2740  
URL [global.ihc.com](http://global.ihc.com); Email [global@ihc.com](mailto:global@ihc.com)

##### HDMI

- HDMI Licensing, LLC, 1060 E. Arques Avenue, Suite 100, Sunnyvale, CA 94085; URL <http://www.hdmi.org>

##### ITU Standards

- International Telecommunications Union, Place des Nations, CH-1211 Geneva 20, Switzerland; Phone +41 22 730 5111; Fax +41 22 733 7256  
URL <http://www.itu.int/publications/default.aspx>; Email [itumail@itu.int](mailto:itumail@itu.int)

##### SMPTE Standards

- Society of Motion Picture & Television Engineers (SMPTE), 595 West Hartsdale Avenue, White Plains, NY 10607; Phone 914-761-1100; Fax 914-761-3115  
URL <http://www.smpite.org/>; Email [smpite@smpite.org](mailto:smpite@smpite.org)

##### Super Audio CD Description

- Philips Intellectual Property & Standards; Building WAH, P.O. Box 220, 5600 AE Eindhoven, The Netherlands; Fax +31-40-2732113; URL <http://www.licensing.philips.com>

CEA-861-C

#### VESA Standards

- Contact Video Electronics Standards Association, 860 Hillview Court, Suite 150, Milpitas, CA 95035, USA, telephone (408) 957-9270, URL: <http://www.vesa.org/>

## 2.2 Definitions

For the purposes of CEA-861-C, the following definitions apply.

**Active Format Description**—A data structure that describes what portion of the picture actually contains useful information (i.e., letterbox and sidebars [bars] are not considered useful information). It is standardized in DVB, and is partially adopted in this standard. Note that the use of the term “active” in this definition is not consistent with the use of this term in other portions of this standard and most of the other documents referenced by this standard.

**Auxiliary Video Information**—Additional information (defined in this standard) related to the video being sent from a source device to a DTV Monitor.

**A/V**—Audio and Video.

**Bars**—Region of the display screen that is being driven or scanned at either zero luminance or at a uniform luminance; or regions of a picture that are intended to be driven (e.g., matrix addressed) or scanned (e.g., CRT) at either zero luminance or at a uniform luminance. In other words, it is the portion of the picture that does not contain useful information.

**Basic Audio**—Uncompressed, two channel, digital audio. Exact parameters are determined by the interface specification used with this standard (e.g., 2 channel IEC60958 LPCM, 32, 44.1, and 48 kHz sampling rates, 16 bits/sample).

**Byte**—8 bits of data.

**CEA Extension**—The E-EDID Standard [8] defines a VESA-assigned tag (02<sub>16</sub>) that allows for an extension to be added with additional timing formats.

**Compressed Audio**—All audio formats other than LPCM and One Bit Audio.

**Digital Television (DTV)**—A device that receives, decodes, and presents audio and video material that has been transmitted in a compressed form. The device can be a single unit or it can be constructed from a number of individual components (e.g. a digital terrestrial set top box and an analog television).

**DTV Monitor**—Defined in this standard to be an EDTV, HDTV, or SDTV Monitor. A DTV Monitor can also be any combination of these terms. A DTV with an uncompressed video input is also considered a DTV Monitor.

**Dual Aspect Ratio Timing**—A video format timing (e.g., 720X480p) that is available in both picture aspect ratios (16:9 and 4:3) with no difference in the timing for the two formats.

**Dual Aspect Ratio DTV Monitor**—A DTV Monitor that simultaneously supports both picture aspect ratios of a video format timing (e.g., 720X480p). Simultaneous support is signified by listing both formats in the EDID data structure at the same time.

**EDTV Monitor**—A video monitor capable of displaying 720x480p in 16:9 or 4:3 aspect ratios.

**Frame Format**—The timing associated with a single frame of video.

**HDTV Monitor**—A video monitor capable of displaying 1920X1080i or 1280X720p video in its format on a 16:9 screen. An HDTV Monitor must also have EDTV Monitor capabilities.

**InfoFrame**—A data transfer structure for sending miscellaneous information from a source device to a DTV monitor over a CEA-861-C interface. Various InfoFrames are described in Section 6.

**Multi-channel Audio**—Digital audio with more than two channels, for example, LPCM, AC-3.

**Native Display Device Aspect Ratio**—Ratio of maximum width to height dimension of the addressable portion of a physical display device screen, which is indicated in the EDID 1.3 block's "Max Horizontal Image Size" and "Max Vertical Image Size" fields.

**Native Format**—A Native Format is a video timing/format that a display device is designed to handle without having to perform a timing or scaling conversion. The number of "native" formats is dependent upon the design of the display device. Each device declares its native format or formats through EDID.

**One Bit Audio**—1-bit Sigma-Delta Delta-Sigma modulated signal stream such as that used by Super Audio CD by the name of DSD (Direct Stream Digital).

**Picture**—That portion of an uncompressed video signal, a compressed video stream, or a sequence on a display that constitutes a single displayable image (i.e., the addressable picture elements). For the purposes of this standard, picture refers to a single video frame in the uncompressed video signal.

**Picture Aspect Ratio**—Ratio of width to height dimension of the picture as delivered across the uncompressed digital interface, including any top, bottom, or side bars. Only two Picture Aspect Ratios are specified for this interface, 16:9 and 4:3.

**Preferred Picture Aspect Ratio**—In a Dual Aspect Ratio DTV Monitor, the preferred aspect ratio of a given Video Format Timing (e.g., 720X480p) is the aspect ratio of the first such timing listed in the EDID data structure (see Section 4.1). This would be the picture aspect ratio that would be displayed if a DTV Monitor were to receive a Video Format Timing with no accompanying picture aspect ratio information (i.e., no AVI sent from source).

**Preferred Format**—The preferred format is the video format listed first in the EDID data structure. Although there may be more than one native format, the one most preferred by the DTV Monitor is listed first.

**RGB**—A general representation of an analog or digital component video signal, where R represents the red color, G represents green, and B represents blue; and each component is sampled at a uniform rate (4,4,4). For the purpose of this standard, the signal is digital.

**SDTV Monitor**—A video monitor capable of displaying 720X480i video in at least one of two aspect ratios, 16:9 or 4:3.

**Uncompressed Audio**—Linear Pulse Code Modulated (LPCM) and One Bit Audio.

**Video Format**—A video format is sufficiently defined such that when it is received at the DTV Monitor, the DTV Monitor has enough information to properly display the video to the user. The definition of each format includes a Video Format Timing, the Picture Aspect Ratio, Colorimetry Space, and Quantization levels.

**Video Format Timing**—The waveform associated with a video format. Note that a specific Video Format Timing may be associated with more than one Video Format (e.g., 720X480p@4:3 and 720X480p@16:9).

**YCbCr**—A general representation of a digital component video signal, where Y represents luminance, C<sub>B</sub> represents the color blue, and C<sub>R</sub> represents red; The color component may be sub-sampled at half the rate as luminance (4:2:2) or may be sampled at a uniform rate (4:4:4). For the purposes of CEA-861-C, it may be considered a digital representation of YP<sub>B</sub>P<sub>R</sub>.

**2.3 Symbols and Abbreviations**

AAC	Advanced Audio Coding
AFD	Active Format Description
ANSI	American National Standards Institute
ATRAC	Adaptive Transform Acoustic Coding
A/V	Audio/Video
AR	Aspect Ratio
AV/C	Audio/Video Control
AVI	Auxiliary Video Information
BD	Blu-Ray Disc
CD	Compact Disk
CRT	Cathode Ray Tube
DAC	Digital to Analog Converter
DBS	Direct Broadcast Satellite
DDWG	Digital Display Working Group
DMT	Display Monitor Timing specification [10]
DSC	Digital Still Camera
DTD	Detailed Timing Descriptor
DTS	Digital Theater System
DTV	Digital Television
DVC	Digital Video Camera
DVD	Digital Versatile Disk
D-VHS	Digital VHS
DVI	Digital Visual Interface [2]
E-DDC	Enhanced Display Data Channel
E-EDID	Enhanced Extended Display Identification Data Standard
EDTV	Enhanced Definition Television
EIA	Electronic Industries Alliance
EUI	Extended Unique Identifier
HDCP	High-bandwidth Digital Content Protection [4]
HDD	Hard Disk Drive
HDMI	High-Definition Multimedia Interface
HDTV	High Definition Television
HPD	Hot Plug Detect
IEC	International Electrotechnical Commission
IEEE	Institute of Electrical and Electronics Engineers
IRE	Percent of white with respect to black
ISO	International Organization for Standardization
ITU	International Telecommunications Union
LCD	Liquid Crystal Display
LPCM	Linear Pulse Code Modulation
lsb	least significant bit
MLP	Meridian Lossless Packing
LVDS	Low Voltage Differential Signaling
MPEG	Moving Picture Experts Group
msb	most significant bit
OpenLDI	Open LVDS Display Interface [7]
OUI	Organizationally Unique Identifier
SACD	Super Audio CD
SADB	Speaker Allocation Data Block
SDTV	Standard Definition Television
SMPTE	Society of Motion Picture & Television Engineers
STB	Set-Top Box
SVD	Short Video Descriptor
VCR	Video Cassette Recorder
VESA	Video Electronics Standards Association



VGA      Video Graphics Adapter  
 VSDB     Vendor Specific Data Block

## 2.4 Compliance Notation

As used in this document, "*shall*" denotes mandatory provisions of the standard. "*Should*" denotes a provision that is recommended but not mandatory. "*May*" denotes a feature whose presence does not preclude compliance and implementation of which is optional. "*Optional*" denotes items that may or may not be present in a compliant device.

## 3 Overview

CEA-861-C describes requirements for video sources and DTV Monitors that include an uncompressed, baseband, digital video interface. These requirements apply to any baseband digital video interface that makes use of VESA E-EDID (structures for discovery of supported video formats) [8] and supports 24-bit RGB. The 60 Hz/59.94 Hz video timings originally defined in 861 are based on analog formats already standardized in CEA-770.2-C [19] and CEA-770.3-C [20]. A preferred physical/link interface is not specified in CEA-861-C. See the annexes on how to apply CEA-861-C to the individual interfaces available at the time of this writing. Digital Visual Interface (DVI 1.0) [2] and OpenLDI 0.95 [7] were available at the time CEA-861 was first published and can be used to enable an CEA-861-level of functionality. CEA-861-C has been enhanced several times since its original release in January 2001. To take advantage of these enhancements, the physical interface also needs a way to transport CEA InfoFrames, digital audio, and  $YC_B C_R$  pixels from the source device to the DTV Monitor. The High-Definition Multimedia Interface (HDMI) [39] is now available to take advantage of these enhancements.

Enhanced Extended Display Identification Data (E-EDID) was created by VESA to enable plug and play capabilities of monitors. This data, which would be stored in the DTV Monitor, describes video formats that the DTV Monitor is capable of receiving and rendering. The information is supplied to the source device, over the interface, upon the request of the source device. The source device then chooses its output format, taking into account the format of the original video stream and the formats supported by the DTV Monitor. The source device (e.g., STB) is responsible for the format conversions necessary to supply video in an understandable form to the DTV Monitor.

CEA-861-C includes the sink device's ability to describe other capabilities in the E-EDID, in addition to supported video formats (e.g., digital audio). In those cases, the same basic mechanism applies (i.e., the source device reads EDID data in the DTV Monitor to determine its capabilities and then the source device only sends what the DTV Monitor can understand).

The physical/link standards in Annexes B, C and D do not support transport of closed captioning (CEA-608-B and CEA-708-B), therefore the source device must undertake any processing of these elements. Specifically, if closed captioning is to be displayed, it must be decoded by the source device, inserted into the video and displayed as open captions. Similarly, System Information, program information, events, service descriptors, etc., if they are displayed, must be graphical information inserted into the video by the source device. Control of closed captioning settings, programs, events, etc. are a feature of the source device, not supported by this interface and beyond the scope of CEA-861-C.

Furthermore, content advisory user menus, settings and blocking must be accommodated in the source device, and is beyond the scope of CEA-861-C.

### 3.1 General Requirements

Any DTV monitor complying with this standard shall support 640x480p (VGA) [10]. Additionally, any DTV Monitor complying with this standard shall also support 720X480p or 720X576p in one of the two picture aspect ratios (4:3 or 16:9) as defined in Section 4.5 or Section 4.9. Additionally, any HDTV Monitor complying with this standard shall also support either 1920x1080i or 1280x720p (with a 16:9 picture

## CEA-861-C

aspect ratio) as defined in Sections 4.3 and 4.4 or Sections 4.7 and 4.8.<sup>2</sup> Formats for 720X480i and 720X576i are also defined in this standard, and are optional. .

Table 1 summarizes display requirements specified by this standard. Incorporated in the same table are recommendations for source devices. These recommendations are based on the CEA's Definitions for Digital Television Products [16]. In the table, the CEA term *tuner* refers to a device that decodes a digital video signal that has been modulated onto an RF carrier and outputs video. To comply with CEA-861-C, a source device does not have to be a tuner.

---

<sup>2</sup> This implicitly allows any source device (intended to supply content to such a DTV Monitor) to only support 720X480p (720X576p for 50 Hz systems) or 640X480p. For the source device to be able to supply high definition content to any HDTV Monitor, it must be capable of supporting 1920x1080i and 1280x720p since the HDTV Monitor may support only one of the two formats. It implies that, in some cases, the source device (e.g., STB) would need to convert the video from the format at its input (e.g., 720X480i) to one of the formats supported by the DTV over this interface (e.g., 720X480p). For additional guidance for source devices see Table 1 and Section 7.2.3.

## 60 Hz Systems

CEA Definition	Video Format	EDTV Monitor (Display)	HDTV Monitor (Display)	EDTV Tuner (Source)	HDTV Tuner (Source)
SDTV	720(1440)x480i @ 60 Hz	○	○	○	○
EDTV	640x480p @ 60 Hz	✕	✕	✓ *	✓ *
EDTV	720x480p @ 60 Hz	✕	✕		
HDTV	1280x720p @ 60 Hz	○	✕ *	○	✓
HDTV	1920x1080i @ 60 Hz	○		○	✓

## 50 Hz Systems

CEA Definition	Video Format	EDTV Monitor (Display)	HDTV Monitor (Display)	EDTV Tuner (Source)	HDTV Tuner (Source)
SDTV	720(1440)x576i @ 50 Hz	○	○	○	○
EDTV	640x480p @ 60 Hz	✕	✕	✓ *	✓ *
EDTV	720x576p @ 50 Hz	✕	✕		
HDTV	1280x720p @ 50 Hz	○	✕ *	○	✓
HDTV	1920x1080i @ 50 Hz	○		○	✓

## Legend

✕	Required by this standard
✕*	Either one of the two formats is required, the other is optional
✓	Recommended by this standard and implied by CEA DTV definitions
✓*	Either one of the two formats is recommended, the other is optional
○	Optional

Table 1 Video Format Timings—Support Requirements and Recommendations

## 4 Video Formats and Waveform Timings

To support the 720x480i, 720x576i, 720x240p or 720x288p video formats, the pixels are double clocked for each line to meet the minimum speed requirements of the interface. Thus, 720x480i is referred to as (1440)x480i in Table, 720x576i is referred to as (1440)x576i, 720x240p is referred to as (1440)x240p, and 720x288p is referred to as (1440)x288p. Additionally, the "2880" formats ((2880)x480i, (2880)x240p, (2880)x576i, and (2880)x288p) each represent a family of formats in which the pixels are repeated a

## CEA-861-C

number of times. The number of times that the pixel is repeated is sent to the DTV Monitor by the source device.

For 60 Hz systems, the DTV Monitor shall be capable of displaying either 59.94 or 60 Hz (frame rate for progressive scan and field rate for interlaced scan) for the formats that it supports. Therefore, the 59.94 Hz and 60 Hz versions of a video format timing shall be considered the same video format with slightly different pixel clocks.

The additional low-resolution progressive video format timings can consist of one of several frame formats (i.e., 1440x240p, 2880x240p, 1440x288p, and 2880x288p). These frame formats differ only by one or two scan lines in the vertical blanking interval. For that reason, they are treated as the same video format with a slight variation in the parameters (i.e., handled in a way similar to the 59.94Hz/60Hz formats). For this reason, if a DTV Monitor declares support of one of these video formats of a specific picture aspect ratio (through EDID), then it shall support all variations of that video format of the same picture aspect ratio. The mandatory and optional formats defined in this standard shall comply with the timing parameters in Table 2.

Low Field Rate	Code	H active	V active	I/P	H total	H blank <sup>5</sup>	V total	V blank <sup>5</sup>	(kHz)	(Hz)	(MHz)
									H Freq <sup>5</sup>	V Freq <sup>4</sup>	Pixel Freq <sup>5</sup>
	32	1920	1080	Prog	2750	830	1125	45	26.973	23.976	74.176
	32	1920	1080	Prog	2750	830	1125	45	27.000	24.000 <sup>3</sup>	74.250
	33	1920	1080	Prog	2640	720	1125	45	28.125	25.000	74.250
	34	1920	1080	Prog	2200	280	1125	45	33.716	29.976	74.176
	34	1920	1080	Prog	2200	280	1125	45	33.750	30.000 <sup>3</sup>	74.250

50Hz	Code	H active	V active	I/P	H total	H blank <sup>5</sup>	V total	V blank <sup>5</sup>	(kHz)	(Hz)	(MHz)
									H Freq <sup>5</sup>	V Freq <sup>4</sup>	Pixel Freq <sup>5</sup>
	17,18	720	576	Prog	864	144	625	49	31.250	50.000	27.000
	19	1280	720	Prog	1980	700	750	30	37.500	50.000	74.250
	20	1920	1080	Int	2640	720	1125	22.5 <sup>1</sup>	28.125	50.000	74.250
	21,22	1440 <sup>2</sup>	576	Int	1728 <sup>2</sup>	288	625	24.5 <sup>1</sup>	15.625	50.000	27.000
	23,24	1440 <sup>2</sup>	288	Prog	1728 <sup>2</sup>	288	312	24	15.625	50.080	27.000
	23,24	1440 <sup>2</sup>	288	Prog	1728 <sup>2</sup>	288	313	25	15.625	49.920	27.000
	23,24	1440 <sup>2</sup>	288	Prog	1728 <sup>2</sup>	288	314	26	15.625	49.761	27.000
	25,26	2880 <sup>2</sup>	576	Int	3456 <sup>2</sup>	576	625	24.5 <sup>1</sup>	15.625	50.000	54.000
	27,28	2880 <sup>2</sup>	288	Prog	3456 <sup>2</sup>	576	312	24	15.625	50.080	54.000
	27,28	2880 <sup>2</sup>	288	Prog	3456 <sup>2</sup>	576	313	25	15.625	49.920	54.000
	27,28	2880 <sup>2</sup>	288	Prog	3456 <sup>2</sup>	576	314	26	15.625	49.761	54.000
	29,30	1440 <sup>2</sup>	576	Prog	1728 <sup>2</sup>	288	625	49	31.250	50.000	54.000
	31	1920	1080	Prog	2640	720	1125	45	56.250	50.000	148.500
	37,38	2880 <sup>2</sup>	576	Prog	3456 <sup>2</sup>	576	625	49	31.250	50.000	108.000
	39	1920	1080	Int	2304	384	1250	85	31.250	50.000	72.000

59.94Hz	Code	H active	V active	I/P	H total	H blank <sup>5</sup>	V total	V blank <sup>5</sup>	(kHz)	(Hz)	(MHz)
									H Freq <sup>5</sup>	V Freq <sup>4</sup>	Pixel Freq <sup>5</sup>
	1	640	480	Prog	800	160	525	45	31.469	59.940	25.175
	2,3	720	480	Prog	858	138	525	45	31.469	59.940	27.000
	4	1280	720	Prog	1650	370	750	30	44.955	59.940	74.176
	5	1920	1080	Int	2200	280	1125	22.5 <sup>1</sup>	33.716	59.940	74.176
	6,7	1440 <sup>2</sup>	480	Int	1716 <sup>2</sup>	276	525	22.5 <sup>1</sup>	15.734	59.940	27.000
	8,9	1440 <sup>2</sup>	240	Prog	1716 <sup>2</sup>	276	262	22	15.734	60.054	27.000
	8,9	1440 <sup>2</sup>	240	Prog	1716 <sup>2</sup>	276	263	23	15.734	59.826	27.000
	10,11	2880 <sup>2</sup>	480	Int	3432 <sup>2</sup>	552	525	22.5 <sup>1</sup>	15.734	59.940	54.000
	12,13	2880 <sup>2</sup>	240	Prog	3432 <sup>2</sup>	552	262	22	15.734	60.054	54.000
	12,13	2880 <sup>2</sup>	240	Prog	3432 <sup>2</sup>	552	263	23	15.734	59.826	54.000
	14,15	1440	480	Prog	1716	276	525	45	31.469	59.940	54.000
	16	1920	1080	Prog	2200	280	1125	45	67.433	59.940	148.352
	35,36	2880 <sup>2</sup>	480	Prog	3432 <sup>2</sup>	552	525	45	31.469	59.940	108.000

Table 2 Video Format Timings—Detailed Timing Information

60 Hz <sup>3</sup>	Code	H active	V active	I/P	H total	H blank <sup>5</sup>	V total	V blank <sup>5</sup>	(kHz)	(Hz)	(MHz)
									H Freq <sup>5</sup>	V Freq <sup>4</sup>	Pixel Freq <sup>5</sup>
	1	640	480	Prog	800	160	525	45	31.500	60.000	25.200
	2,3	720	480	Prog	858	138	525	45	31.500	60.000	27.027
	4	1280	720	Prog	1650	370	750	30	45.000	60.000	74.250
	5	1920	1080	Int	2200	280	1125	22.5 <sup>1</sup>	33.750	60.000	74.250
	6,7	1440 <sup>2</sup>	480	Int	1716 <sup>2</sup>	276	525	22.5 <sup>1</sup>	15.750	60.000	27.027
	8,9	1440 <sup>2</sup>	240	Prog	1716 <sup>2</sup>	276	262	22	15.750	60.115	27.027
	8,9	1440 <sup>2</sup>	240	Prog	1716 <sup>2</sup>	276	263	23	15.750	59.886	27.027
	10,11	2880 <sup>2</sup>	480	Int	3432 <sup>2</sup>	552	525	22.5 <sup>1</sup>	15.750	60.000	54.054
	12,13	2880 <sup>2</sup>	240	Prog	3432 <sup>2</sup>	552	262	22	15.750	60.115	54.054
	12,13	2880 <sup>2</sup>	240	Prog	3432 <sup>2</sup>	552	263	23	15.750	59.886	54.054
	14,15	1440 <sup>2</sup>	480	Prog	1716 <sup>2</sup>	276	525	45	31.500	60.000	54.054
	16	1920	1080	Prog	2200	280	1125	45	67.500	60.000	148.500
	35,36	2880	480	Prog	3432	552	525	45	31.500	60.000	108.108

100 Hz	Code	H active	V active	I/P	H total	H blank <sup>5</sup>	V total	V blank <sup>5</sup>	(kHz)	(Hz)	(MHz)
									H Freq <sup>5</sup>	V Freq <sup>4</sup>	Pixel Freq <sup>5</sup>
	40	1920	1080	Int	2640	720	1125	22.5 <sup>1</sup>	56.250	100.00	148.500
	41	1280	720	Prog	1980	700	750	30	75.000	100.00	148.500
	42, 43	720	576	Prog	864	144	625	49	62.500	100.00	54.000
	44, 45	1440 <sup>2</sup>	576	Int	1728 <sup>2</sup>	288	625	24.5 <sup>1</sup>	31.250	100.00	54.000

119.88 Hz	Code	H active	V active	I/P	H total	H blank <sup>5</sup>	V total	V blank <sup>5</sup>	(kHz)	(Hz)	(MHz)
									H Freq <sup>5</sup>	V Freq <sup>4</sup>	Pixel Freq <sup>5</sup>
	46	1920	1080	Int	2200	280	1125	22.5 <sup>1</sup>	67.432	119.88	148.352
	47	1280	720	Prog	1650	370	750	30	89.909	119.88	148.352
	48, 49	720	480	Prog	858	138	525	45	62.937	119.88	54.000
	50, 51	1440 <sup>2</sup>	480	Int	1716 <sup>2</sup>	276	525	22.5 <sup>1</sup>	31.469	119.88	54.000

120 Hz <sup>3</sup>	Code	H active	V active	I/P	H total	H blank <sup>5</sup>	V total	V blank <sup>5</sup>	(kHz)	(Hz)	(MHz)
									H Freq <sup>5</sup>	V Freq <sup>4</sup>	Pixel Freq <sup>5</sup>
	46	1920	1080	Int	2200	280	1125	22.5 <sup>1</sup>	67.500	120.00	148.500
	47	1280	720	Prog	1650	370	750	30	90.000	120.00	148.500
	48, 49	720	480	Prog	858	138	525	45	63.000	120.00	54.054
	50, 51	1440 <sup>2</sup>	480	Int	1716 <sup>2</sup>	276	525	22.5 <sup>1</sup>	31.500	120.00	54.054

200 Hz	Code	H active	V active	I/P	H total	H blank <sup>5</sup>	V total	V blank <sup>5</sup>	(kHz)	(Hz)	(MHz)
									H Freq <sup>5</sup>	V Freq <sup>4</sup>	Pixel Freq <sup>5</sup>
	52, 53	720	576	Prog	864	144	625	49	125.000	200.00	108.00
	54, 55	1440 <sup>2</sup>	576	Int	1728 <sup>2</sup>	288	625	24.5 <sup>1</sup>	62.500	200.00	108.00

Table 2 Video Format Timings—Detailed Timing Information (Continued)

239.76 Hz	Code	H active	V active	I/P	H total	H blank <sup>5</sup>	V total	V blank <sup>5</sup>	(kHz) H Freq <sup>5</sup>	(Hz) V Freq <sup>4</sup>	(MHz) Pixel Freq <sup>5</sup>
	56, 57	720	480	Prog	858	138	525	45	125.874	239.76	108.000
58, 59	1440 <sup>2</sup>	480	Int	1716 <sup>2</sup>	276	525	22.5 <sup>1</sup>	62.937	239.76	108.000	

240 Hz <sup>3</sup>	Code	H active	V active	I/P	H total	H blank <sup>5</sup>	V total	V blank <sup>5</sup>	(kHz) H Freq <sup>5</sup>	(Hz) V Freq <sup>4</sup>	(MHz) Pixel Freq <sup>5</sup>
	56,57	720	480	Prog	858	138	525	45	126.000	240.00	108.108
58,59	1440 <sup>2</sup>	480	Int	1716 <sup>2</sup>	276	525	22.5 <sup>1</sup>	63.000	240.00	108.108	

**NOTES**

1 V blanking—Fractional values indicate that the number of blanking lines varies (see timing diagram for more details).

2 Note: the pixels for the 720xN 480i, 240p, 576i, and 288p formats (where N is the number of lines) are double clocked for each line to meet minimum speed requirements of the interface, thus H active is shown as 1440, instead of 720. Each pixel of the 1440xN 480p and 576p formats, as well as the 2880xN 480i, 240p, 480p, 576i, 288p, and 576p formats, is repeated a variable number of times. The repeat value is communicated using the AVI InfoFrames (see Section 6.4).

3 Format Note: For 60 Hz formats, the display will respond automatically to either 60 Hz or 59.94 Hz (same format with slightly different clocks). The 25.2 MHz pixel frequency value is within the +/- 0.5% (allowed in the VESA DMT [10]) of 25.175 MHz. The 480p formats and the 480i formats are typically 59.94 Hz, and the HDTV formats are typically 60 Hz.

4 To avoid fractional frame rate conversions in source and sink devices, source devices should use the exact vertical frequencies of 25.000 Hz, 50.000 Hz, 100.000 Hz, 120.000 Hz, 200.000 Hz, and 240.000 Hz at 25 Hz, 50 Hz, 100 Hz, 120 Hz, 200 Hz, and 240 Hz, respectively. Likewise, source devices should use the exact vertical frequencies of (24 \* 1000) / 1001 Hz, (30 \* 1000) / 1001 Hz, (60 \* 1000) / 1001 Hz, (120 \* 1000) / 1001 Hz, and (240 \* 1000) / 1001 Hz at 24.98 Hz, 29.97 Hz, 59.94 Hz, 119.88 Hz, 239.76 Hz, respectively.

5 Data in this column is provided for informational purposes only.

**Table 2 Video Format Timings—Detailed Timing Information (Continued)**

**4.1 Aspect Ratio**

A DTV Monitor should always indicate its native (physical) aspect ratio in the EDID 1.3 block's "Max Horizontal Image Size" and "Max Vertical Image Size" fields even if the maximum image size is unknown or variable. The ratio of these two fields will typically be 16:9 or 4:3 though this may not be true for some displays with non-standard aspect ratios. The source should use these fields to determine the native aspect ratio of the display.

The 480p, 480i, 240p, 576p, 576i, and 288p formats are available in two different aspect ratios (4:3 and 16:9). Video formats with the same timing, but different picture aspect ratios are considered different formats that can be independently supported and discovered. These are referred to as dual-aspect ratio timings.

For any dual-aspect ratio video timing, the Preferred Picture Aspect Ratio for that timing is indicated by the first listing of that timing in the EDID. When receiving a signal not accompanied by an aspect ratio indication (because no AVI InfoFrame is transmitted) a DTV Monitor shall assume that the aspect ratio is the Primary Picture Aspect Ratio for the transmitted video timing.

For a display device to simultaneously support both formats, the source device needs a way to let the display device know the picture aspect ratio in which the video should be displayed. A DTV Monitor shall list only one picture aspect ratio of any dual-aspect ratio timing unless it is capable of receiving and decoding the AVI InfoFrame defined in Section 6.



However, it is possible for a DTV Monitor that has no support for the AVI InfoFrame to still support both aspect ratios of such formats as a user programmable option. In that case, the EDID Detailed Timing Descriptor could be modified during operation to reflect the selected picture aspect ratio and the change could be signaled to the source (e.g. with Hot Plug Detect on DVI or HDMI).

The effects on the EDID data structure are explained in Section 7.2.2. See Table 3 for Video ID Code and Aspect Ratios.

Video ID Code	Formats	Field Rate	Picture Aspect Ratio (H:V) <sup>1</sup>	Pixel Aspect Ratio (H:V)
1	640x480p	59.94Hz/60Hz	4:3	1:1
2	720x480p	59.94Hz/60Hz	4:3	8:9
3	720x480p	59.94Hz/60Hz	16:9	32:27
4	1280x720p	59.94Hz/60Hz	16:9	1:1
5	1920x1080i	59.94Hz/60Hz	16:9	1:1
6	720(1440)x480i	59.94Hz/60Hz	4:3	8:9
7	720(1440)x480i	59.94Hz/60Hz	16:9	32:27
8	720(1440)x240p	59.94Hz/60Hz	4:3	4:9
9	720(1440)x240p	59.94Hz/60Hz	16:9	16:27
10	2880x480i	59.94Hz/60Hz	4:3	2:9 - 20:9 <sup>3</sup>
11	2880x480i	59.94Hz/60Hz	16:9	8:27 - 80:27
12	2880x240p	59.94Hz/60Hz	4:3	1:9 - 10:9
13	2880x240p	59.94Hz/60Hz	16:9	4:27 - 40:27
14	1440x480p	59.94Hz/60Hz	4:3	4:9
15	1440x480p	59.94Hz/60Hz	16:9	16:27
16	1920x1080p	59.94Hz/60Hz	16:9	1:1
17	720x576p	50Hz	4:3	16:15
18	720x576p	50Hz	16:9	64:45
19	1280x720p	50Hz	16:9	1:1
20	1920x1080i	50Hz	16:9	1:1
21	720(1440)x576i	50Hz	4:3	16:15
22	720(1440)x576i	50Hz	16:9	64:45
23	720(1440)x288p	50Hz	4:3	8:15
24	720(1440)x288p	50Hz	16:9	32:45
25	2880x576i	50Hz	4:3	2:15 - 20:15
26	2880x576i	50Hz	16:9	16:45-160:45
27	2880x288p	50Hz	4:3	1:15 - 10:15
28	2880x288p	50Hz	16:9	8:45 - 80:45
29	1440x576p	50Hz	4:3	8:15
30	1440x576p	50Hz	16:9	32:45
31	1920x1080p	50Hz	16:9	1:1
32	1920x1080p	23.97Hz/24Hz	16:9	1:1
33	1920x1080p	25Hz	16:9	1:1
34	1920x1080p	29.97Hz/30Hz	16:9	1:1
35	2880x480p	59.94Hz/60Hz	4:3	2:9
36	2880x480p	59.94Hz/60Hz	16:9	8:27

**Table 3 Video Formats—Video ID Code and Aspect Ratios**

<sup>3</sup> Although the pixel repeat field is 4 bits (see Section 6.4), the largest value used for typical formats is 10. Therefore, in this standard the pixel repeat value can vary from 1 to 10. This results in a factor of 10 variation in the Pixel Aspect Ratio.

Video ID Code	Formats	Field Rate	Picture Aspect Ratio (H:V) <sup>1</sup>	Pixel Aspect Ratio (H:V)
37	2880x576p	50Hz	4:3	4:15
38	2880x576p	50Hz	16:9	16:45
39	1920x1080i (1250 total)	50Hz	16:9	1:1
40	1920x1080i	100Hz	16:9	1:1
41	1280x720p	100Hz	16:9	1:1
42	720x576p	100Hz	4:3	16:15
43	720x576p	100Hz	16:9	64:45
44	720(1440)x576i	100Hz	4:3	16:15
45	720(1440)x576i	100Hz	16:9	64:45
46	1920x1080i	119.88/120Hz	16:9	1:1
47	1280x720p	119.88/120Hz	16:9	1:1
48	720x480p	119.88/120Hz	4:3	8:9
49	720x480p	119.88/120Hz	16:9	32:27
50	720(1440)x480i	119.88/120Hz	4:3	8:9
51	720(1440)x480i	119.88/120Hz	16:9	32:27
52	720X576p	200Hz	4:3	16:15
53	720X576p	200Hz	16:9	64:45
54	720(1440)x576i	200Hz	4:3	16:15
55	720(1440)x576i	200Hz	16:9	64:45
56	720x480p	239.76/240Hz	4:3	8:9
57	720x480p	239.76/240Hz	16:9	32:27
58	720(1440)x480i	239.76/240Hz	4:3	8:9
59	720(1440)x480i	239.76/240Hz	16:9	32:27
60-127	Reserved for the Future			
0	No Video Code Available (Used with AVI InfoFrame only)			

<sup>1</sup>Picture Aspect Ratio—The display will state what picture aspect ratios it supports for a given format, and the source can choose how to support it. For example, with the 720X480 (16x9) data format and a 4x3 display, the source could (1) use pan and scan information to crop the data to 540 horizontal pixels and then resample up to the required 720 pixels for output to the display or (2) vertically resample to 360 lines and create bars of 60 lines above and below it to send this "letterbox" with the required 480 lines for output. Other picture scaling methods are possible in either source device or DTV Monitor. For example, picture aspect ratio scaling (picture expand, shrink, etc.) can be accomplished in the source device, including, possibly, added black/gray lines in the addressable pixel portion of the video. The exception to this is the 640x480 format, which is always sent as 4x3 data, and it is up to the display to determine how it wants to display it.

Table 3 Video Formats—Video ID Code and Aspect Ratios

**4.2 640x480p @ 59.94/60 Hz (Format 1)**

This timing is based on the timing in *VESA Monitor Timings Specification*, version 1.0 revision [10] and is available only in a 4:3 aspect ratio]. The only difference is where VESA defines blanking as not including the border while CEA-861-C includes the border within the blanking interval. Unlike the other formats, PC quantization levels (i.e., 256 levels in the case of RGB) are used for this format. See Figure 1.

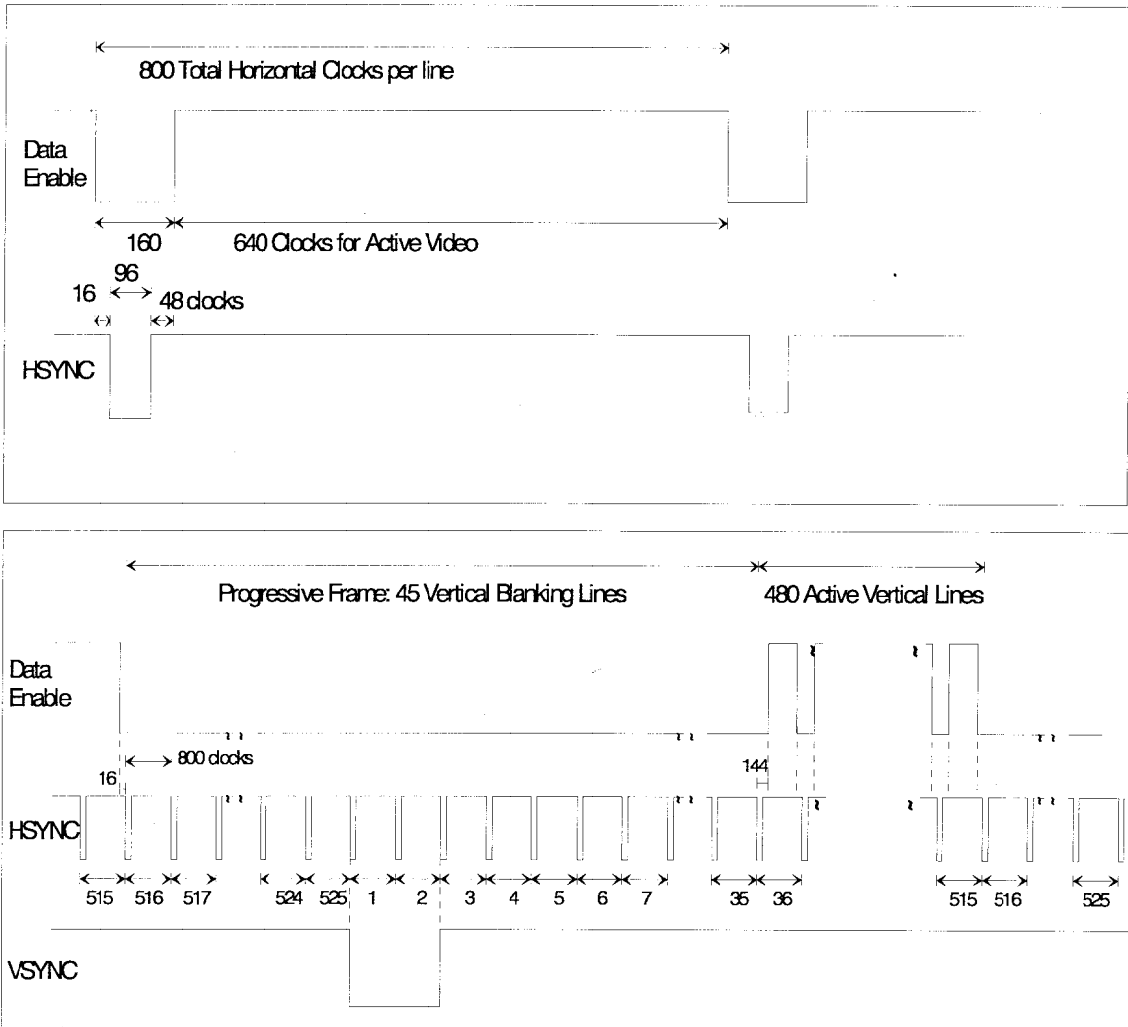
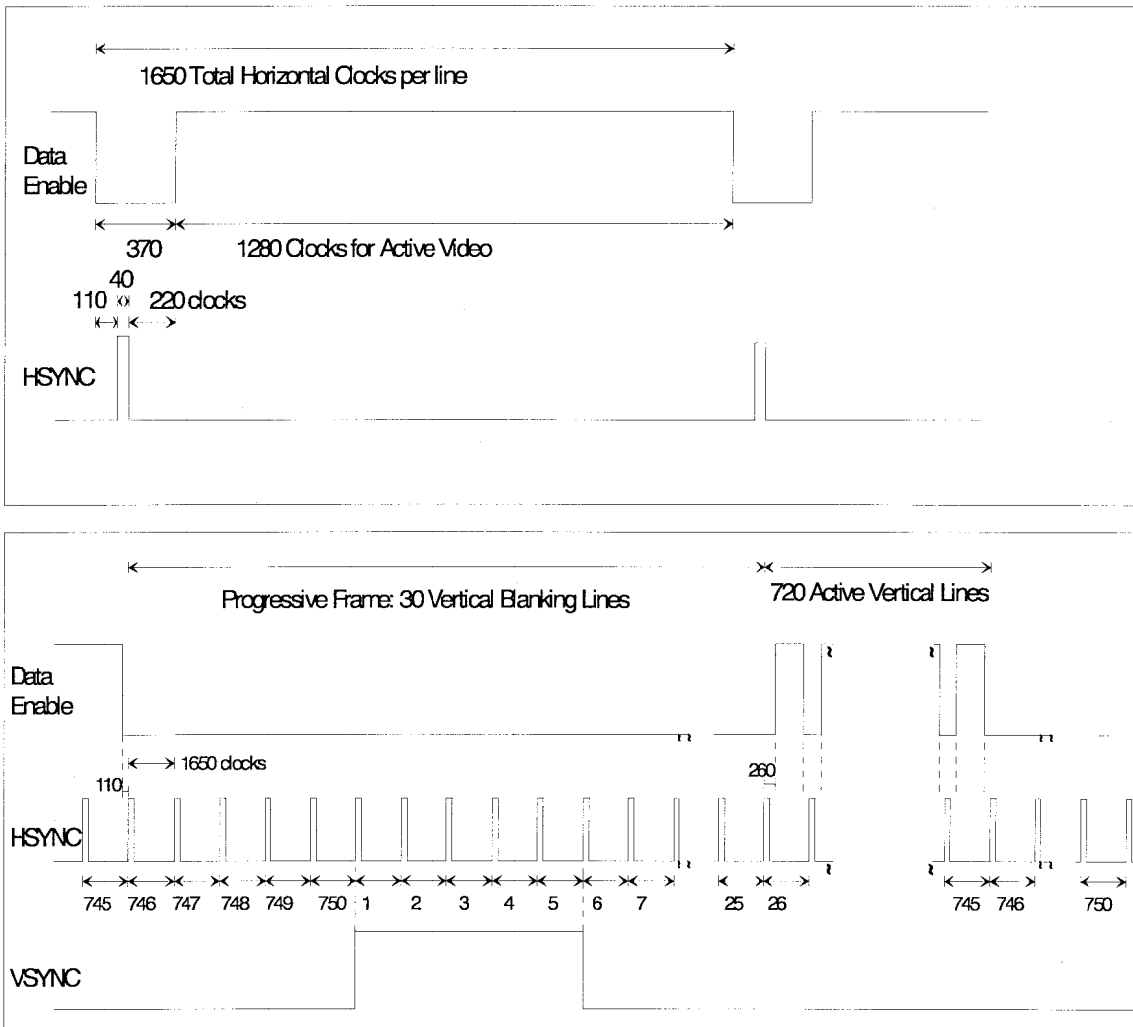

**Figure 1 Timing Parameters for 640x480p @ 59.94/60 Hz**

**4.3 1280x720p @ 59.94/60 Hz (Format 4)**

This format is available only in a 16:9 aspect ratio. This timing is based on CEA-770.3-C [20], but there are two differences. First, CEA-770.3-C uses tri-level sync, while CEA-861-C uses bi-level. Bi-level sync timing is accomplished using the second half of the CEA-770.3-C tri-level sync, defining the actual sync time to be the rising edge of that pulse.

Second, CEA-770.3-C uses a composite sync while CEA-861-C uses separate sync signals, thus eliminating the need for serrations during vertical sync. See Figure 2.



**Figure 2 Timing Parameters for 1280x720p @ 59.94/60 Hz**

CEA-861-C

4.4 1920x1080i @59.94/60 Hz (Format 5)

This format is available only in a 16:9 aspect ratio. This timing is based on CEA-770.3-C [20], but there are two differences: First, CEA-770.3-C uses tri-level sync, while CEA-861-C uses bi-level. Bi-level sync timing is accomplished using the second half of the CEA-770.3-C tri-level sync, defining the actual sync time to be the rising edge of that pulse. See Figure 3 .

Second, CEA-770.3-C uses a composite sync while CEA-861-C uses separate sync signals, thus eliminating the need for serrations during vertical sync.

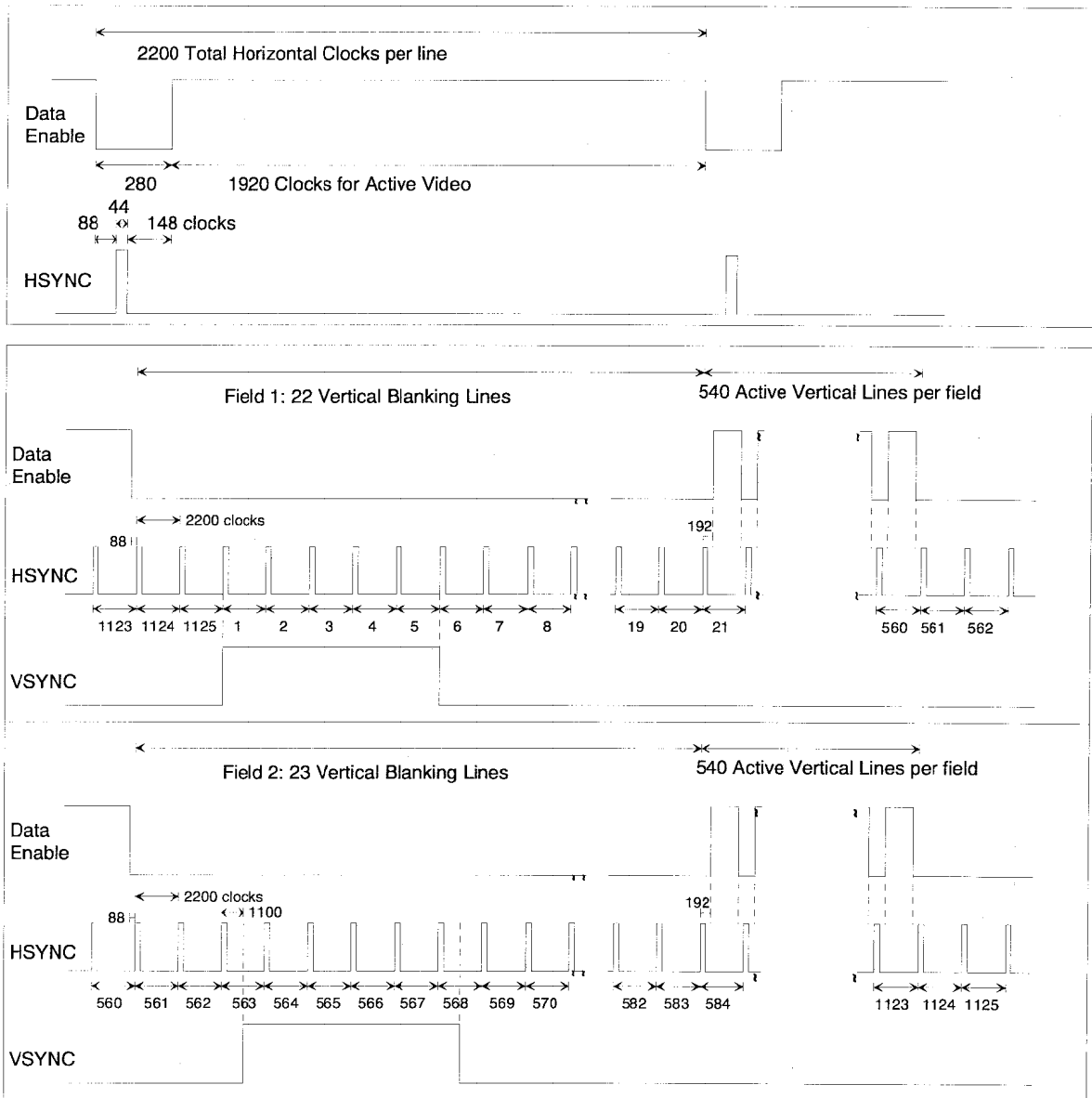
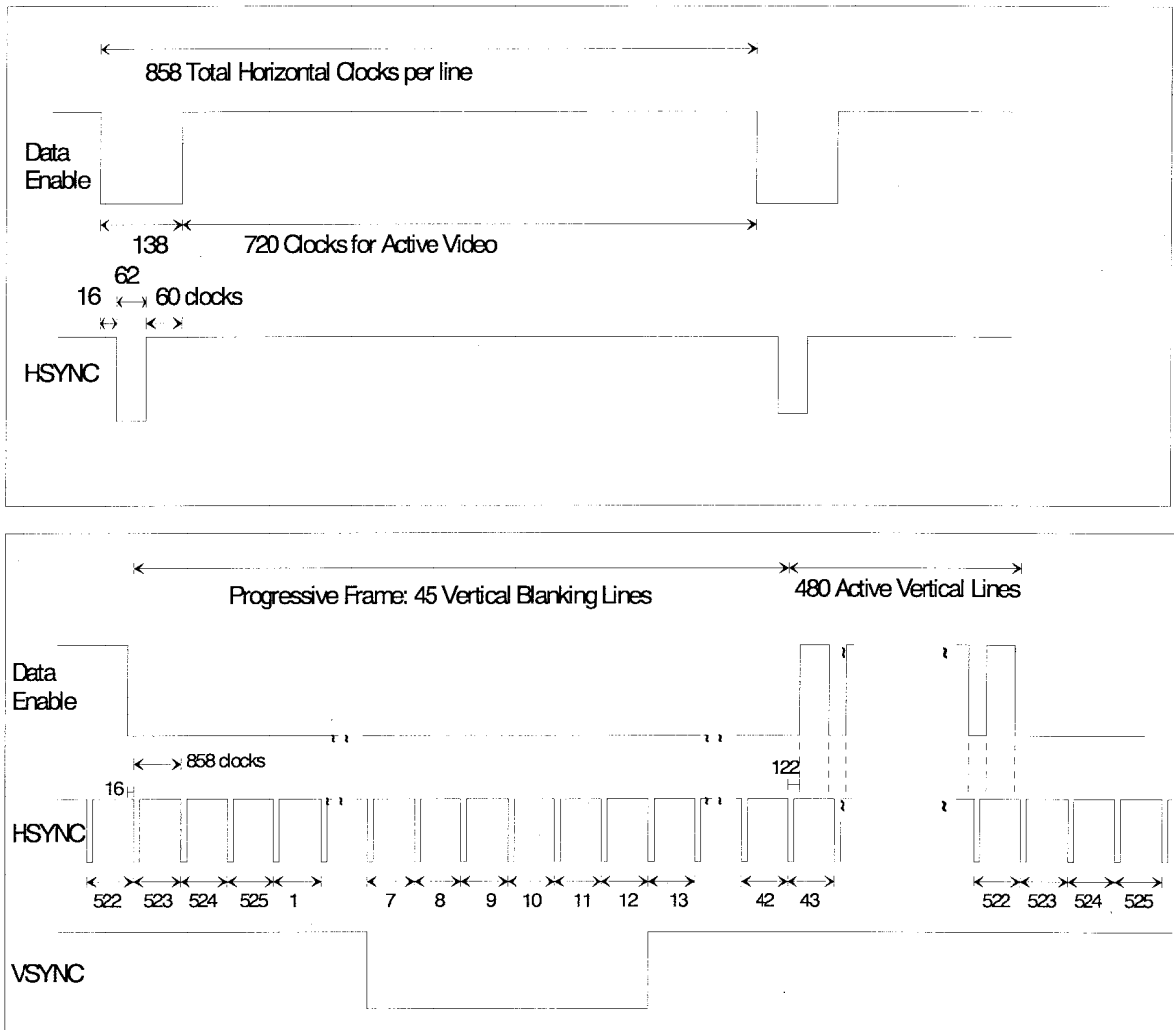

Figure 3 Timing Parameters for 1920x1080i @ 59.94/60 Hz

**4.5 720x480p @ 59.94/60 Hz (Formats 2 & 3)**

This timing is based on CEA-770.2-C [19], with one difference. CEA-770.2-C has a composite sync while CEA-861-C uses separate sync signals, thus eliminating the need for serrations during vertical sync. This format timing can use either 4:3 or 16:9 aspect ratio. See Figure 4.



**Figure 4 Timing Parameters for 720x480p @ 59.94/60 Hz**

**4.6 720(1440)x480i @59.94/60 Hz (Formats 6 & 7)**

This timing is based on CEA-770.2-C [19], with a few differences. CEA-770.2-C has a composite sync while CEA-861-C uses separate sync signals, thus eliminating the need for serrations during vertical sync. This format also assumes the pixels are double clocked to meet minimum clock speed requirements for the interface. This format timing can use either 4:3 or 16:9 aspect ratio. See Figure 5.

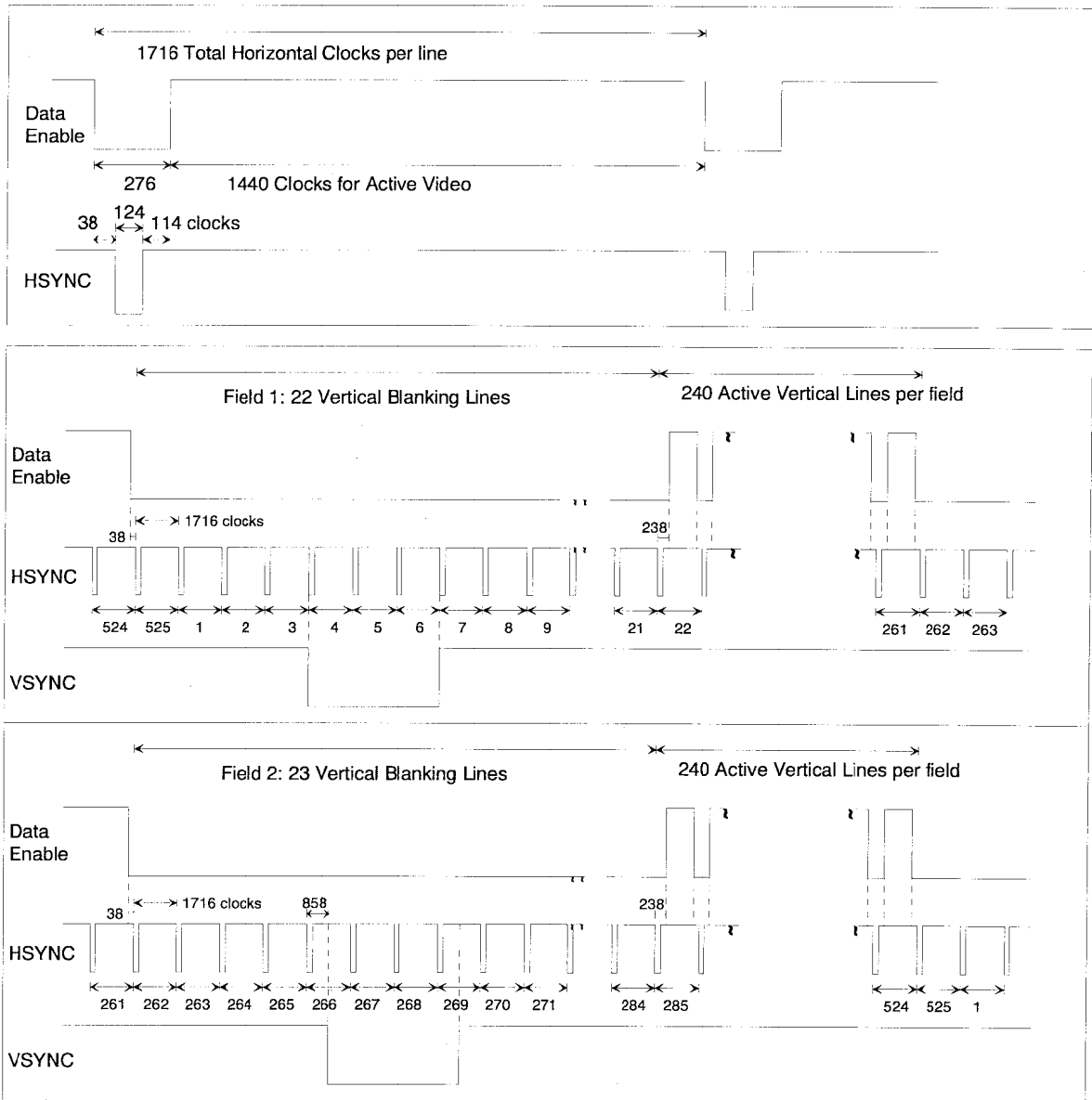

**Figure 5 Timing Parameters for 720(1440)x480i @ 59.94/60 Hz**



**4.7 1280x720p @ 50 Hz (Format 19)**

This format is available only in a 16:9 aspect ratio. This timing is based on SMPTE 296M [14], but there are two differences. First, SMPTE 296M uses tri-level sync, while CEA-861-C uses bi-level. Bi-level sync timing is accomplished using the second half of the SMPTE 296M tri-level sync, defining the actual sync time to be the rising edge of that pulse. See Figure 6.

Second, SMPTE 296M uses a composite sync while CEA-861-C uses separate sync signals, thus eliminating the need for serrations during vertical sync.

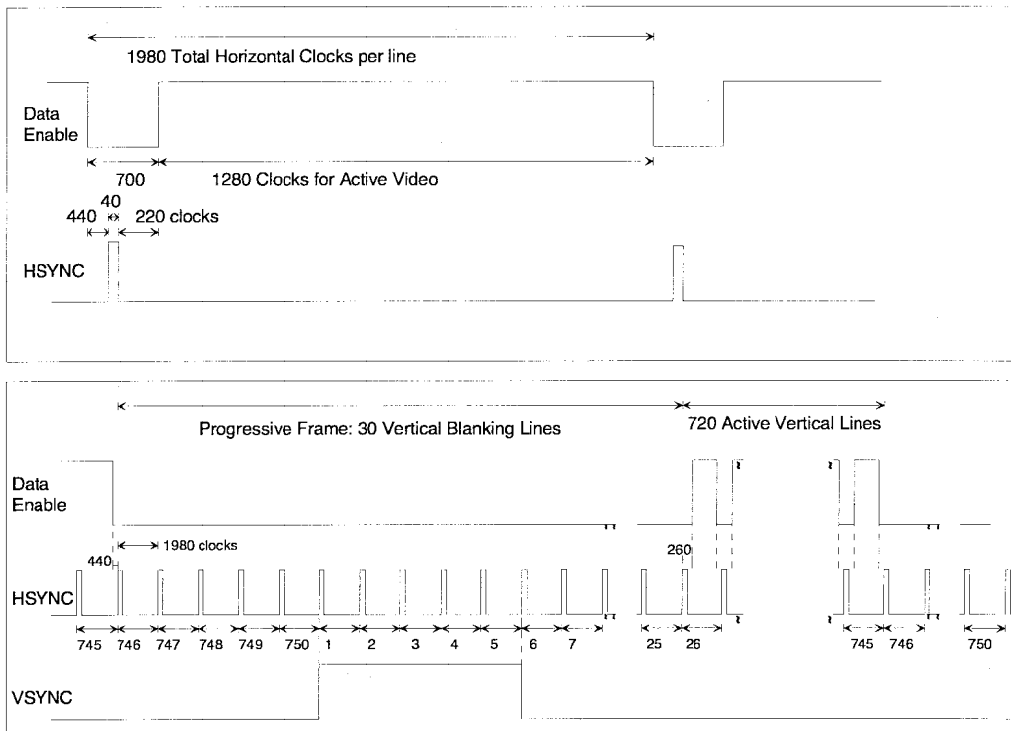

**Figure 6 Timing Parameters for 1280x720p @ 50 Hz**

CEA-861-C

**4.8 1920x1080i @ 50 Hz (Format 20)**

This format is available only in a 16:9 aspect ratio. This timing is based on SMPTE 274M [12], but there are two differences: First, SMPTE 274M uses tri-level sync, while CEA-861-C uses bi-level. Bi-level sync timing is accomplished using the second half of the SMPTE 274M tri-level sync, defining the actual sync time to be the rising edge of that pulse. See Figure 7.

Second, SMPTE 274M uses a composite sync while CEA-861-C uses separate sync signals, thus eliminating the need for serrations during vertical sync.

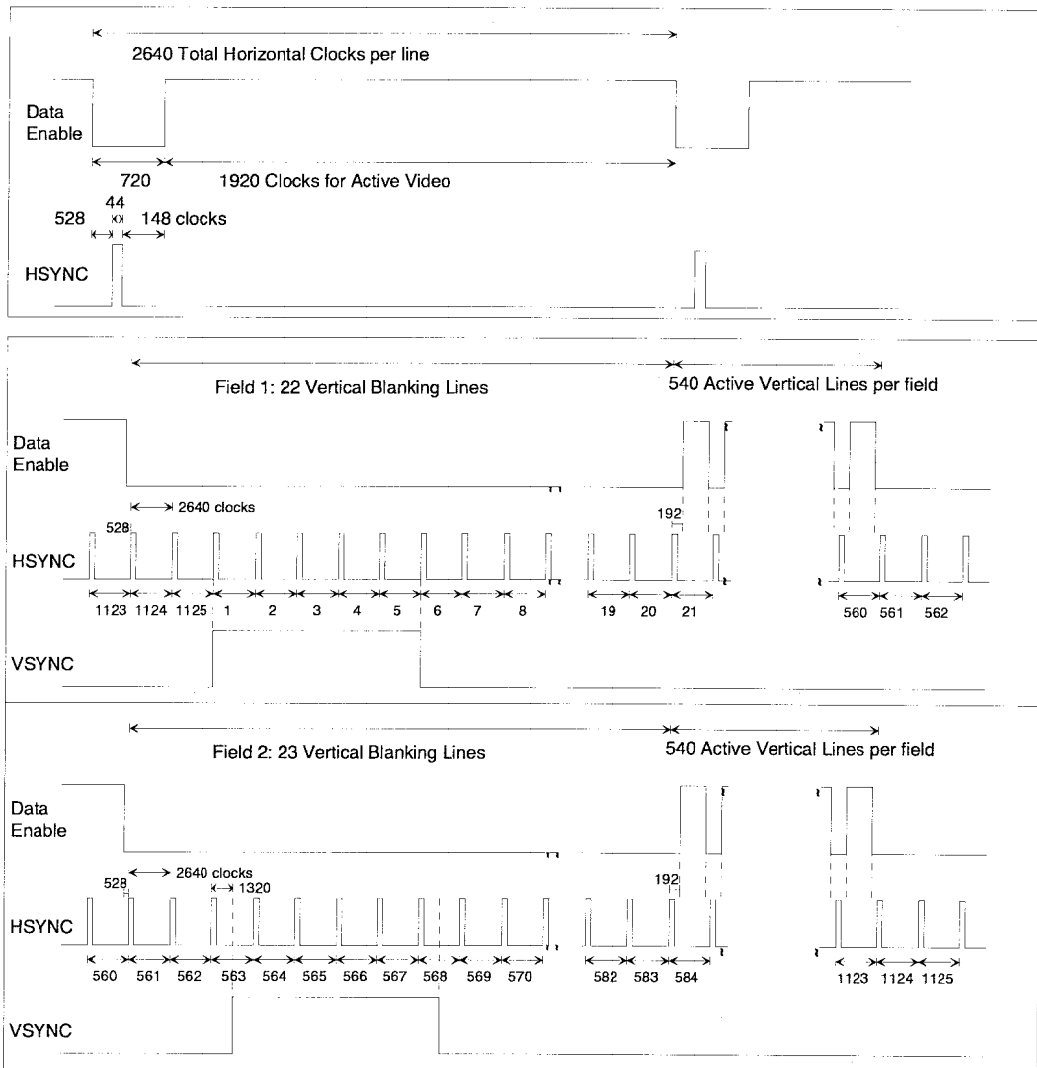
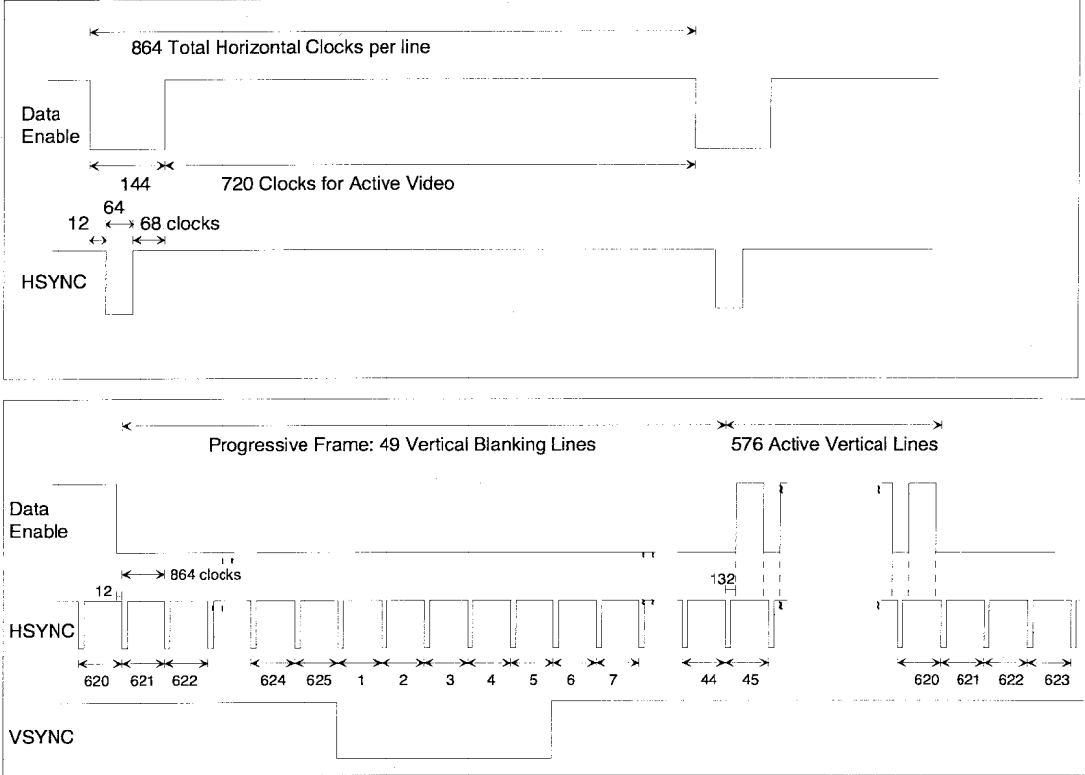

Figure 7 Timing Parameters for 1920x1080i @ 50 Hz

**4.9 720x576p @ 50 Hz (Formats 17 & 18)**

This timing is based on ITU-R BT.1358 [29]. This format timing can use either 4:3 or 16:9 aspect ratio. See Figure 8.



**Figure 8 Timing Parameters for 720x576p @ 50 Hz**

**4.10 720(1440)x576i @ 50 Hz (Formats 21 & 22)**

This timing is based on ITU-R BT.656-4 [31] except for horizontal and vertical synchronization pulse durations, which are specified in ITU-R BT.711-1 [32] and ITU-R BT.470-6 [30]. This format assumes the pixels are double clocked to meet minimum clock speed requirements for the interface. Thus, the clock is 27 MHz. This format timing can use either 4:3 or 16:9 aspect ratio. See Figure 9.

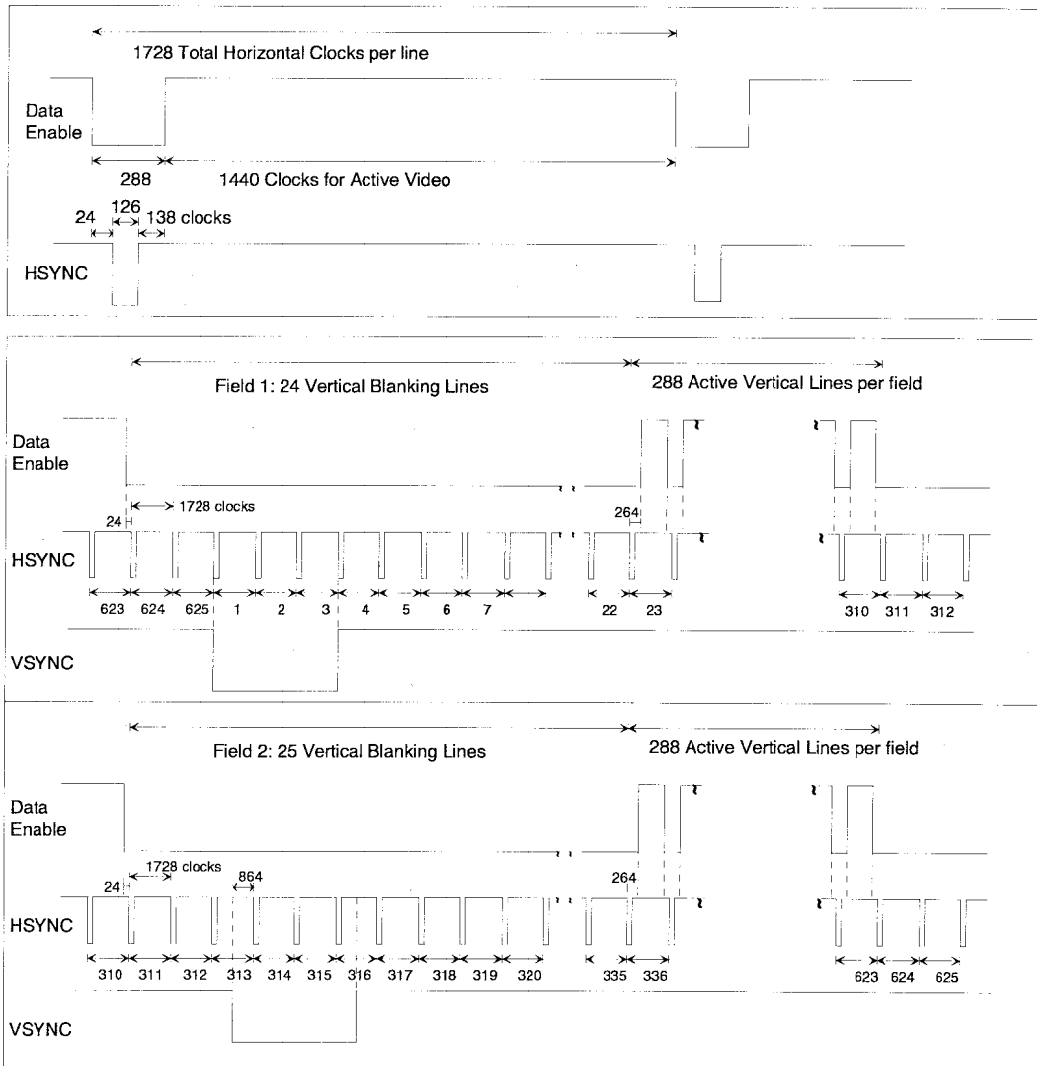
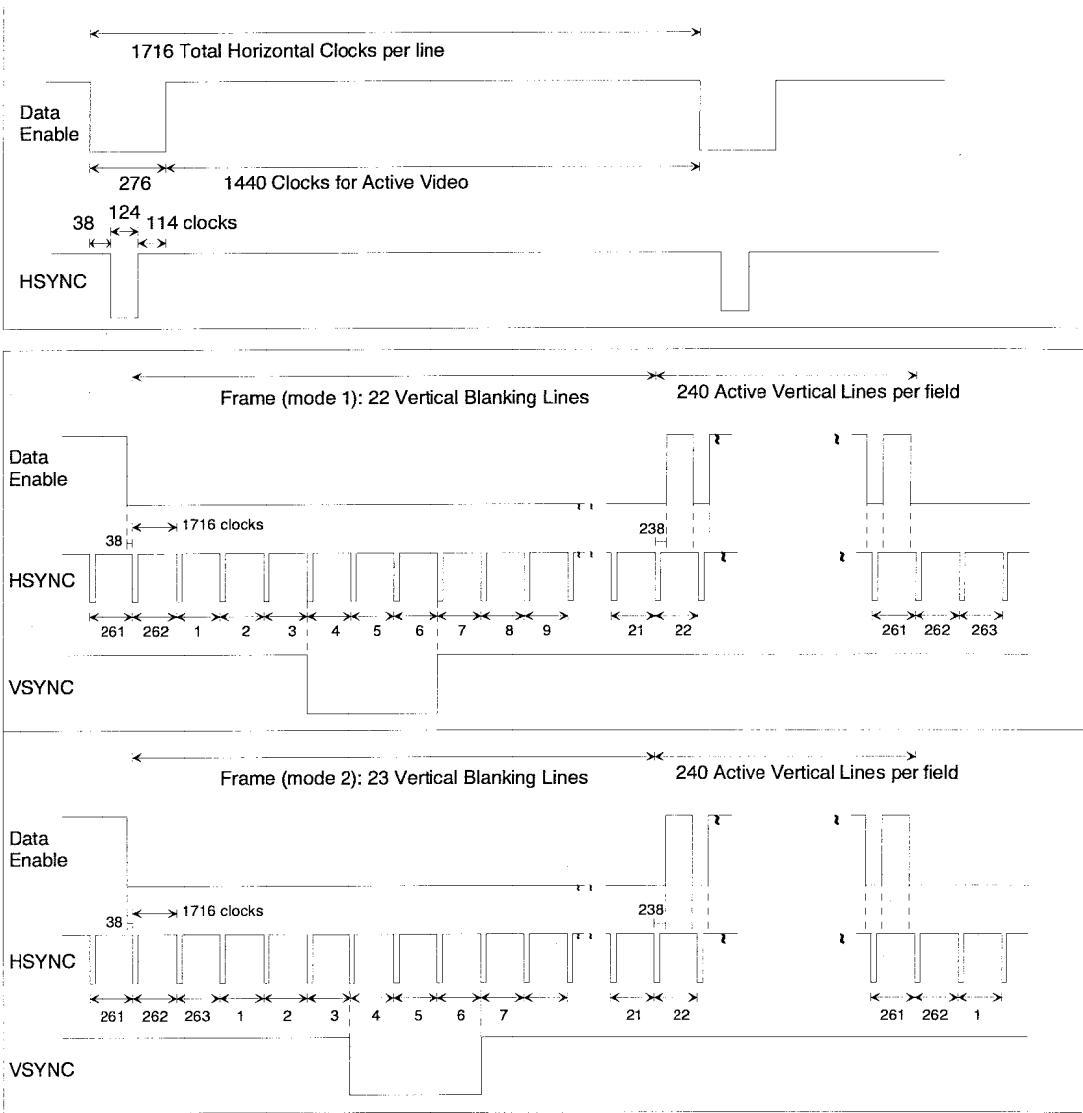

**Figure 9 Timing Parameters for 720(1440)x576i @ 50 Hz**

**4.11 720(1440)x240p @ 59.94/60 Hz (Formats 8 & 9)**

This format assumes the pixels are double clocked to meet minimum clock speed requirements for the interface. There are two possible frame formats that differ only in the number of lines in the vertical blanking interval of the frame. Both are considered variations of the same format. This format timing can use either 4:3 or 16:9 aspect ratio. See Figure 10.

Designers should be aware that this format was not defined in prior versions of this standard and it is likely that non-HDMI source devices may not recognize this format in a Detailed Timing Descriptor.



**Figure 10 Timing Parameters for 720(1440)x240p @ 59.94/60 Hz**

## CEA-861-C

### 4.12 (2880)x480i @ 59.94/60 Hz (Formats 10 & 11)

This format is a superset of a variety of video formats used in various game consoles. This format is unique in that, depending upon the pixel repetition factor specified in the AVI InfoFrame, this format can represent any of the following typical formats:

- a)  $2880/10=288$  pixels/line
- b)  $2880/8=360$  pixels/line
- c)  $2880/7=411$  pixels/line
- d)  $2880/5=576$  pixels/line
- e)  $2880/4=720$  pixels/line

The pixel repetition factor is specified in the AVI. The DTV Monitor indicates it can accept any of the formats implied by this format superset through EDID. See Figure 11.

This format will also typically have bars on the left and right sides. These bars will be  $160/n$  pixels wide where  $n$  is the repetition factor.

This format timing can use either 4:3 or 16:9 aspect ratio.

Users should be aware that this format, due to the repetition factor, is only supported with HDMI implementations of CEA-861-C.

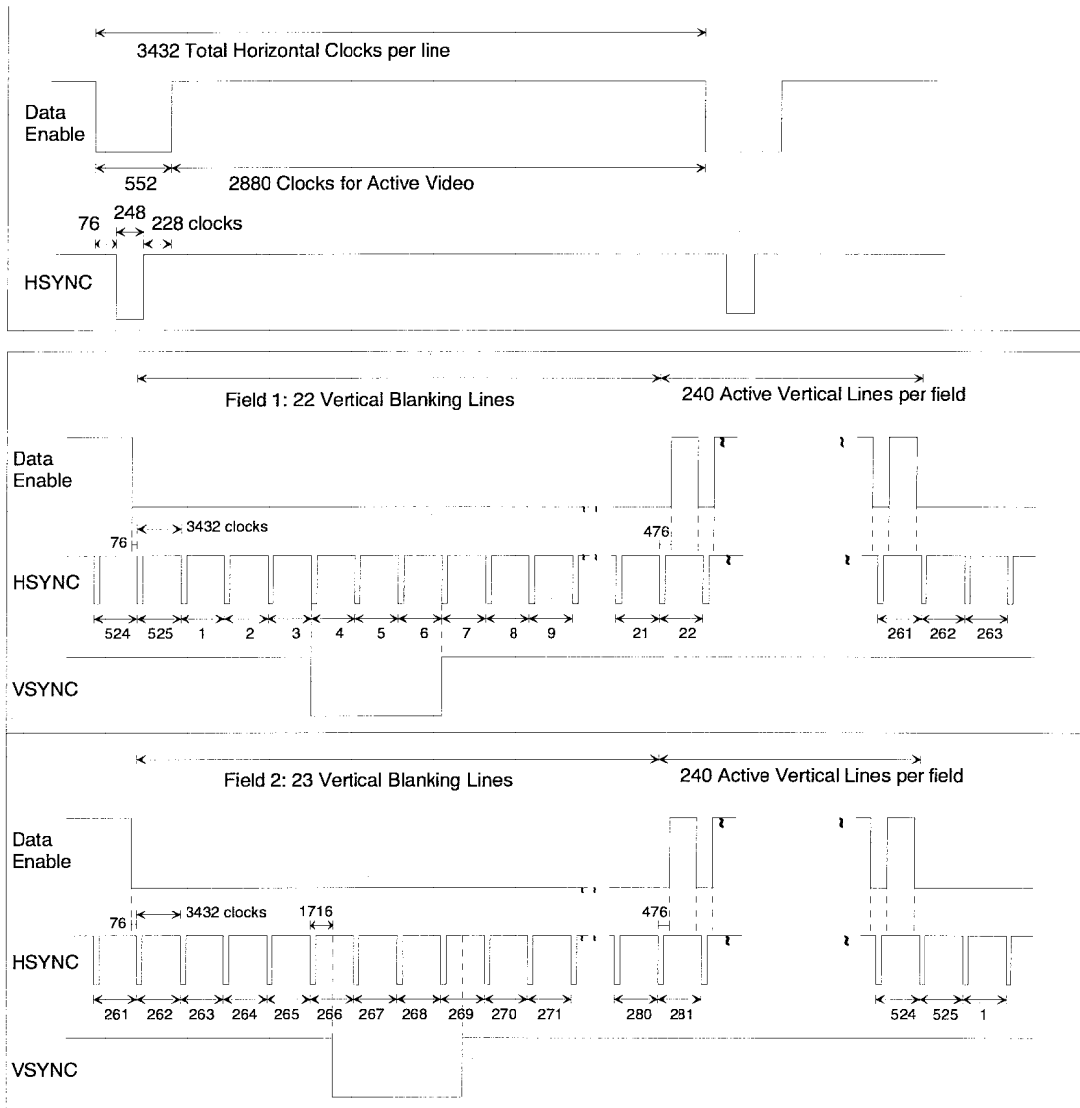

**Figure 11 Timing Parameters for (2880)x480i @ 59.94/60 Hz**

#### 4.13 (2880)x240p @ 59.94/60 Hz (Formats 12 & 13)

This format is a superset of a variety of video formats used in various game consoles. This format is unique in that, depending upon the pixel repetition factor specified in the AVI InfoFrame, this format can represent any of the following typical formats:

- a)  $2880/10=288$  pixels/line
- b)  $2880/8=360$  pixels/line
- c)  $2880/7=411$  pixels/line
- d)  $2880/5=576$  pixels/line
- e)  $2880/4=720$  pixels/line

The pixel repetition factor is specified in the AVI. The DTV Monitor indicates it can accept any of the formats implied by this format superset through EDID. See Figure 12.

CEA-861-C

This format will also typically have bars on the left and right sides. These bars will be  $160/n$  pixels wide where  $n$  is the repetition factor.

There are two possible frame formats that differ only in the number of lines in the vertical blanking interval of the frame. Both are considered variations of the same format.

This format timing can use either 4:3 or 16:9 aspect ratio.

Users should be aware that this format, due to the repetition factor, is only supported with HDMI implementations of this standard.

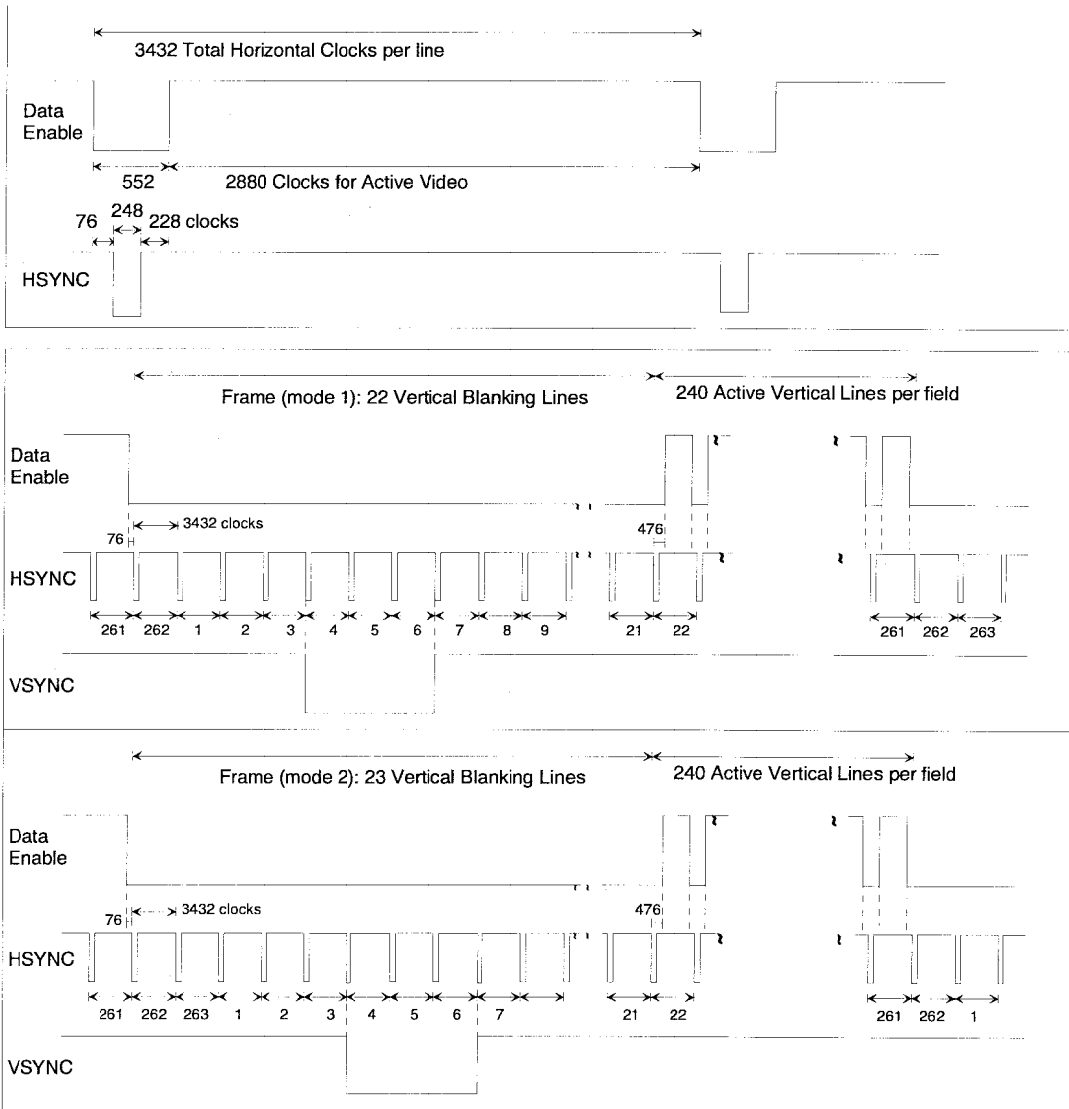

Figure 12 Timing Parameters for (2880)x240p @ 59.94/60 Hz



**4.14 1440x480p @ 59.94/60 Hz (Formats 14 & 15)**

This format can use either 4:3 or 16:9 aspect ratio. It provides either additional horizontal video resolution or additional bandwidth for carrying audio data. See Figure 13.

Depending upon the pixel repetition factor specified in the AVI InfoFrame, this format can represent either of the following typical formats:

- a)  $1440/2=720$  pixels/line
- b)  $1440/1=1440$  pixels/line

The first format is typically used to increase the available bandwidth for audio transmission on HDMI while transmitting the normal 720 pixels per line. The second format is used to increase the horizontal resolution. If this timing is advertised in the EDID, the DTV Monitor shall be able to accept either of these two pixel repetition factors.

Users should be aware that this format was not defined in prior versions of CEA-861-C and it is likely that non-HDMI source devices may not recognize this format in a Detailed Timing Descriptor.

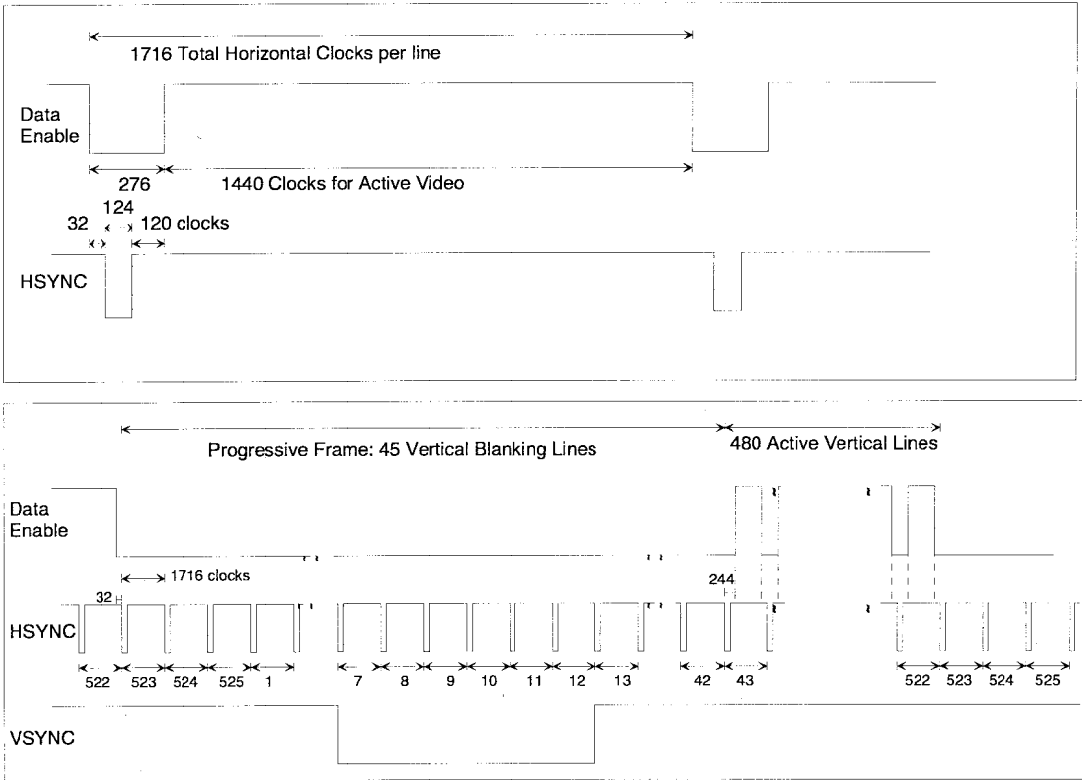

**Figure 13 Timing Parameters for 1440x480p @ 59.94/60 Hz**

**4.15 1920x1080p @ 59.94/60Hz (Format 16)**

This format is available only in a 16:9 aspect ratio. Users should be aware that this format was not defined in prior versions of CEA-861-C, and it is likely that non-HDMI source devices may not recognize this format in a Detailed Timing Descriptor. See Figure 14.

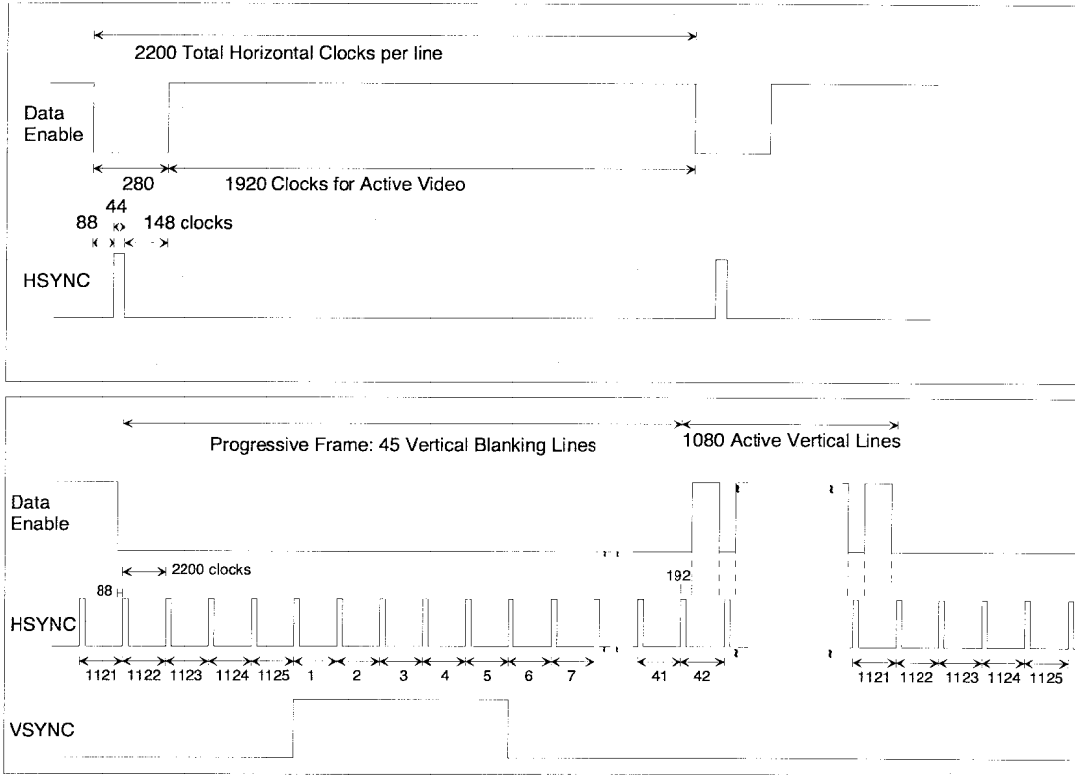

**Figure 14 Timing Parameters for 1920x1080p @ 59.94/60 Hz**

**4.16 720(1440)x288p @ 50 Hz (Formats 23 & 24)**

This format assumes the pixels are double clocked to meet minimum clock speed requirements for the interface. There are three possible frame formats that differ only in the number of lines in the vertical blanking interval of the frame. All three are considered variations of the same format. See Figure 15.

This format timing can use either 4:3 or 16:9 aspect ratio. Users should be aware that this format was not defined in previous versions of CEA-861-C, and it is likely that non-HDMI source devices may not recognize this format in a Detailed Timing Descriptor.

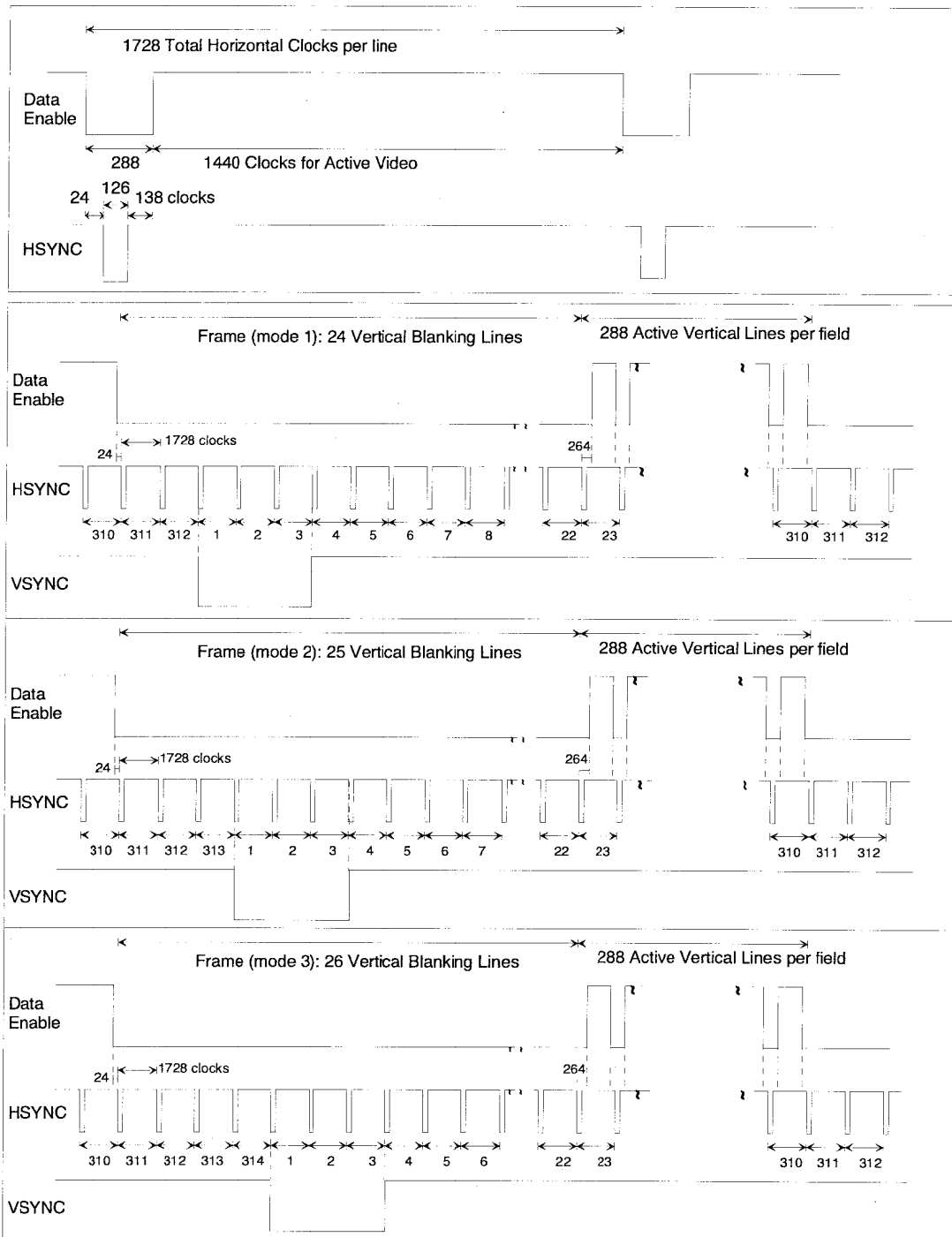

Figure 15 Timing Parameters for 720(1440)x288p @ 50 Hz

**4.17 (2880)x576i @ 50Hz (Formats 25 & 26)**

This format is a superset of a variety of video formats used in various game consoles. This format is unique in that, depending upon the pixel repetition factor specified in the AVI InfoFrame, this format can represent any of the following typical formats:

- a)  $2880/10=288$  pixels/line
- b)  $2880/8=360$  pixels/line
- c)  $2880/7=411$  pixels/line
- d)  $2880/5=576$  pixels/line
- e)  $2880/4=720$  pixels/line

See Figure 16. The pixel repetition factor is specified in the AVI. The DTV Monitor indicates it can accept any of the formats implied by this format superset through EDID.

This format will also typically have bars on the left and right sides. These bars will be  $160/n$  pixels wide where  $n$  is the repetition factor.

This format timing can use either 4:3 or 16:9 aspect ratio.

Users should be aware that this format was not defined in prior versions of CEA-861-C, and it is likely that non-HDMI source devices may not recognize this format in a Detailed Timing Descriptor.

CEA-861-C

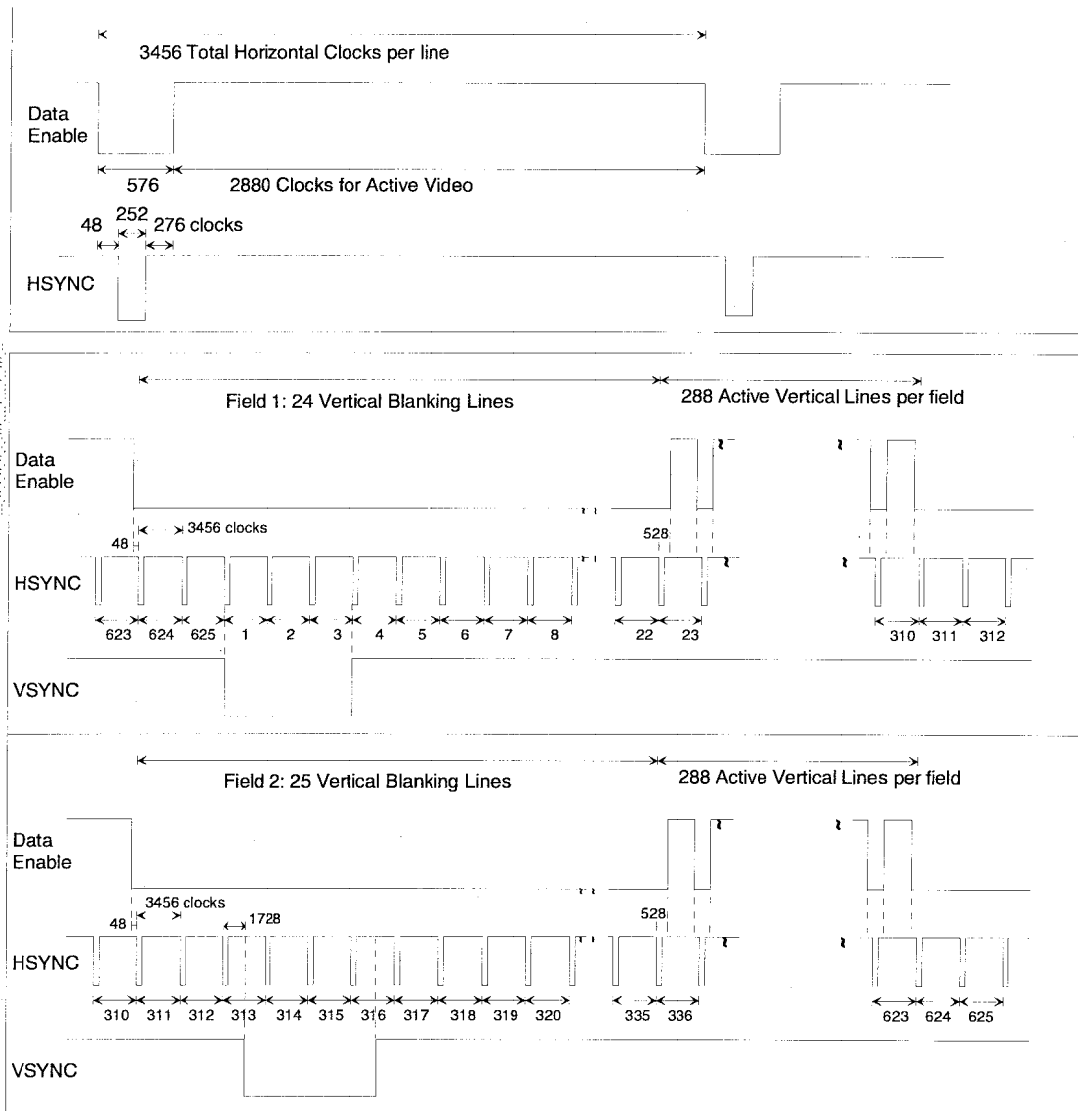

Figure 16 Timing Parameters for (2880)x576i @ 50 Hz

**4.18 (2880)x288p @ 50 Hz (Formats 27 & 28)**

This format is a superset of a variety of video formats used in various game consoles. This format is unique in that, depending upon the pixel repetition factor specified in the AVI InfoFrame, this format can represent any of the following typical formats:

- a)  $2880/10=288$  pixels/line
- b)  $2880/8=360$  pixels/line
- c)  $2880/7=411$  pixels/line
- d)  $2880/5=576$  pixels/line
- e)  $2880/4=720$  pixels/line

See Figure 17. The pixel repetition factor is specified in the AVI. The DTV Monitor indicates it can accept any of the formats implied by this format superset through EDID.

This format will also typically have bars on the left and right sides. These bars will be  $160/n$  pixels wide where  $n$  is the repetition factor.

There are three possible frame formats that differ only in the number of lines in the vertical blanking interval of the frame. All three are considered variations of the same format.

This format timing can use either 4:3 or 16:9 aspect ratio.

Users should be aware that this format, due to the repetition factor, is only supported by interfaces capable of signaling pixel repetition via AVI Infoframes, such as HDMI.

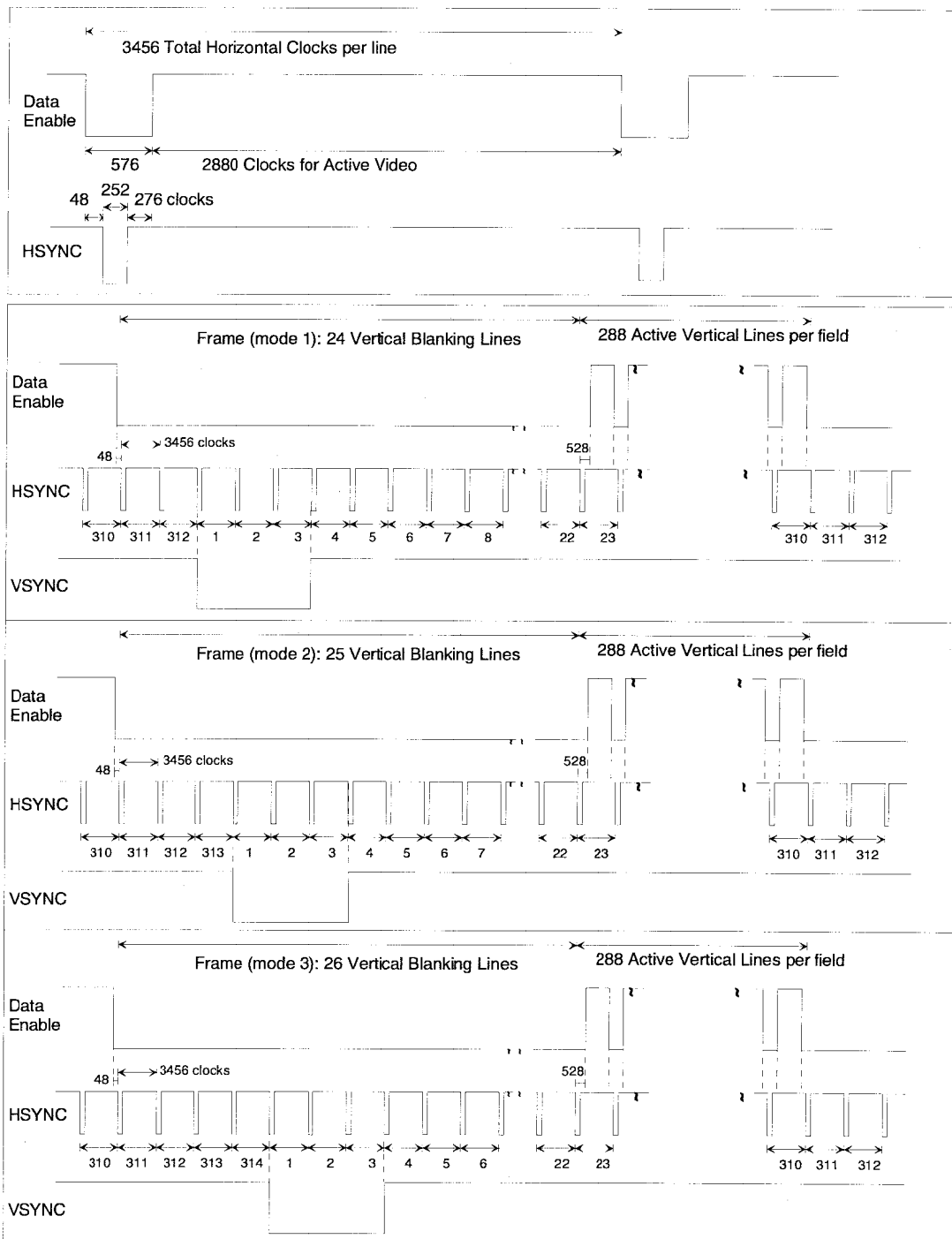

Figure 17 Timing Parameters for (2880)x288p @ 50 Hz



**4.19 1440x576p @ 50Hz (Formats 29 & 30)**

This format can use either 4:3 or 16:9 aspect ratio. It provides either additional horizontal video resolution or additional bandwidth for carrying audio data.

Depending upon the pixel repetition factor specified in the AVI InfoFrame, this format can represent either of the following typical formats:

- a)  $1440/2=720$  pixels/line
- b)  $1440/1=1440$  pixels/line

The first format is typically used to increase the available bandwidth for audio transmission on HDMI while transmitting the normal 720 pixels per line. The second format is used to increase the horizontal resolution. If this timing is advertised in the EDID, the DTV Monitor shall be able to accept either of these two pixel repetition factors. See Figure 18.

Users should be aware that this format was not defined in previous versions of CEA-861-C, and it is likely that non-HDMI source devices may not recognize this format in a Detailed Timing Descriptor.

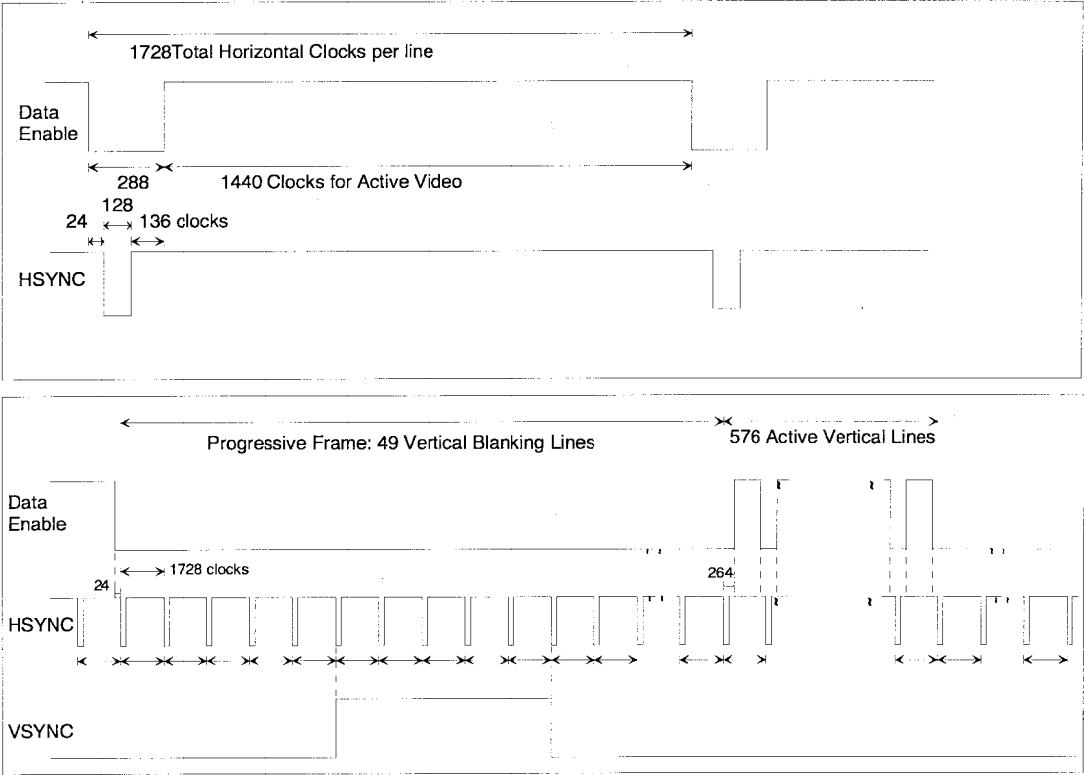

**Figure 18 Timing Parameters for 1440x576p @ 50 Hz**

**4.20 1920x1080p @ 50 Hz (Format 31)**

This format is available only in a 16:9 aspect ratio. Users should be aware that this format was not defined in previous versions of CEA-861-C, and it is likely that non-HDMI source devices may not recognize this format in a Detailed Timing Descriptor. See Figure 19.

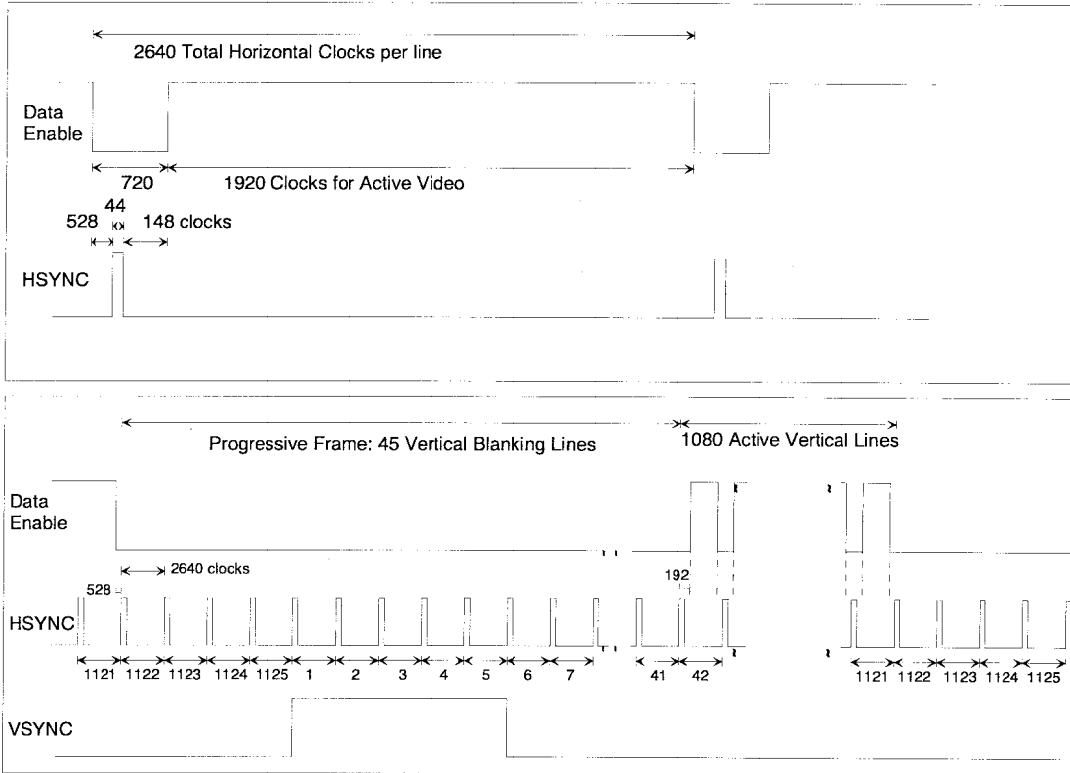

**Figure 19 Timing Parameters for 1920x1080p @ 50 Hz**

**4.21 1920x1080p @ 23.98/24 Hz (Format 32)**

This format is available only in a 16:9 aspect ratio. Users should be aware that this format was not defined in previous versions of CEA-861-C, and it is likely that non-HDMI source devices may not recognize this format in a Detailed Timing Descriptor. See Figure 20.

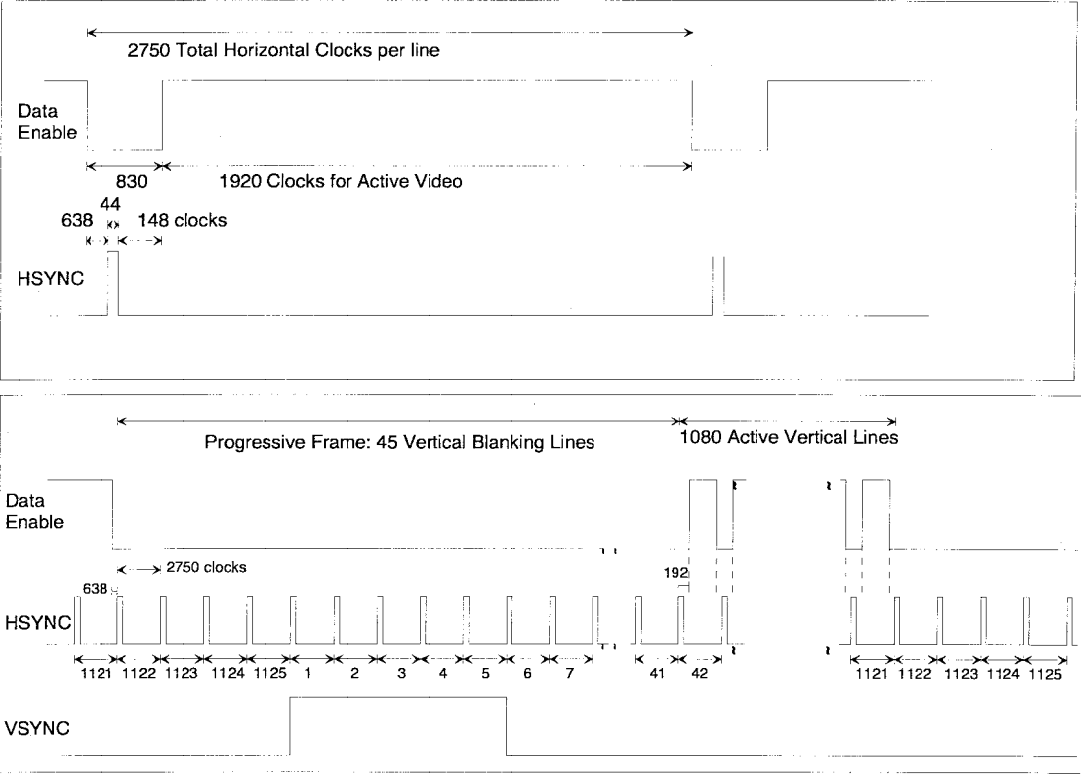

**Figure 20 Timing Parameters for 1920x1080p @ 23.98/24 Hz**

**4.22 1920x1080p @ 25 Hz (Format 33)**

This format is available only in a 16:9 aspect ratio. Users should be aware that this format was not defined in previous versions of CEA-861-C, and it is likely that non-HDMI source devices may not recognize this format in a Detailed Timing Descriptor. See Figure 21.

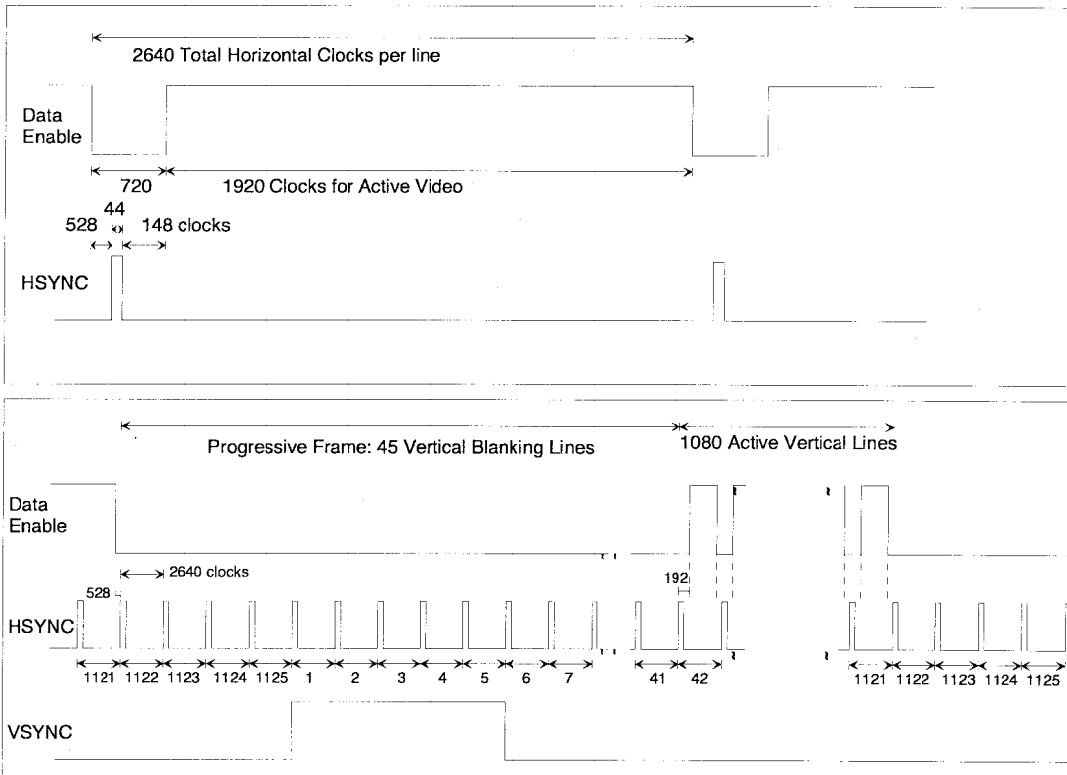

**Figure 21 Timing Parameters for 1920x1080p @ 25 Hz**

**4.23 1920x1080p @ 29.97/30 Hz (Format 34)**

This format is available only in a 16:9 aspect ratio. Users should be aware that this format was not defined in previous versions of CEA-861-C, and it is likely that non-HDMI source devices may not recognize this format in a Detailed Timing Descriptor. See Figure 22.

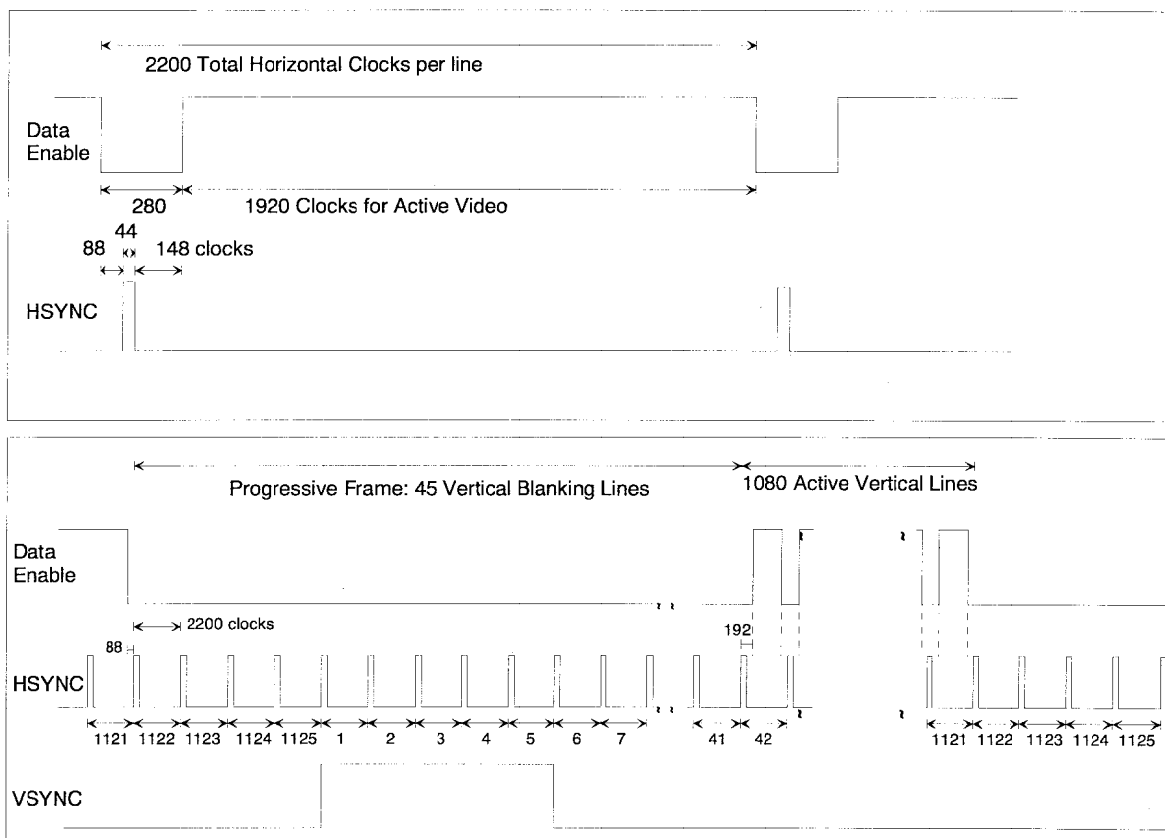

**Figure 22 Timing Parameters for 1920x1080p @ 29.97/30 Hz**

**4.24 2880x480p @ 59.94/60 Hz (Formats 35 and 36)**

These formats can use either 4:3 or 16:9 aspect ratio. They provide additional bandwidth for carrying audio data and can also provide additional horizontal video resolution. See Figure 23.

Depending upon the pixel repetition factor specified in the AVI InfoFrame, these formats can represent any of the following formats:

- a)  $2880/4=720$  pixels/line
- b)  $2880/2=1440$  pixels/line
- b)  $2880/1=2880$  pixels/line

If this timing is advertised in the EDID, the DTV Monitor shall be able to accept any of these pixel repetition factors.

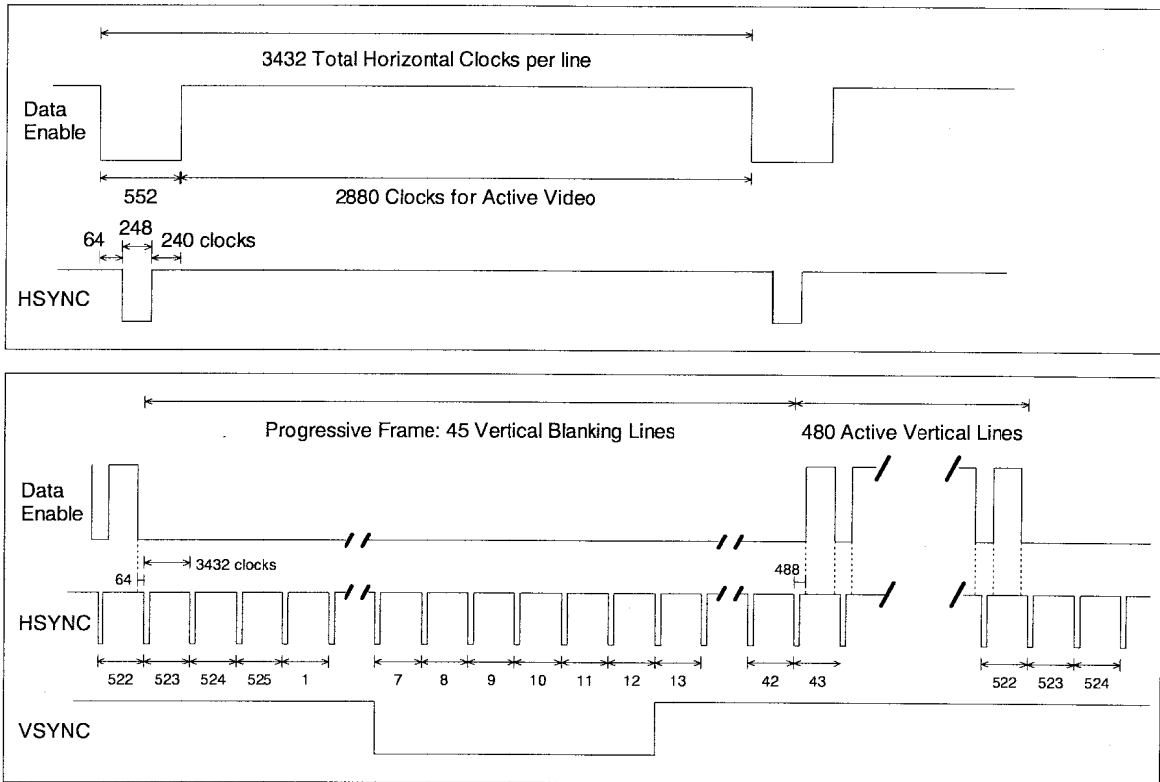

**Figure 23 Timing Parameters for 2880x480p @ 59.94/60 Hz**

#### 4.25 2880x576p @ 50 Hz (Formats 37 and 38)

These formats can use either 4:3 or 16:9 aspect ratio. They provide additional bandwidth for carrying audio data and can also provide additional horizontal video resolution. See Figure 24.

Depending upon the pixel repetition factor specified in the AVI InfoFrame, these formats can represent any of the following formats:

- a)  $2880/4=720$  pixels/line
- b)  $2880/2=1440$  pixels/line
- b)  $2880/1=2880$  pixels/line

If this timing is advertised in the EDID, the DTV Monitor shall be able to accept any of these pixel repetition factors.

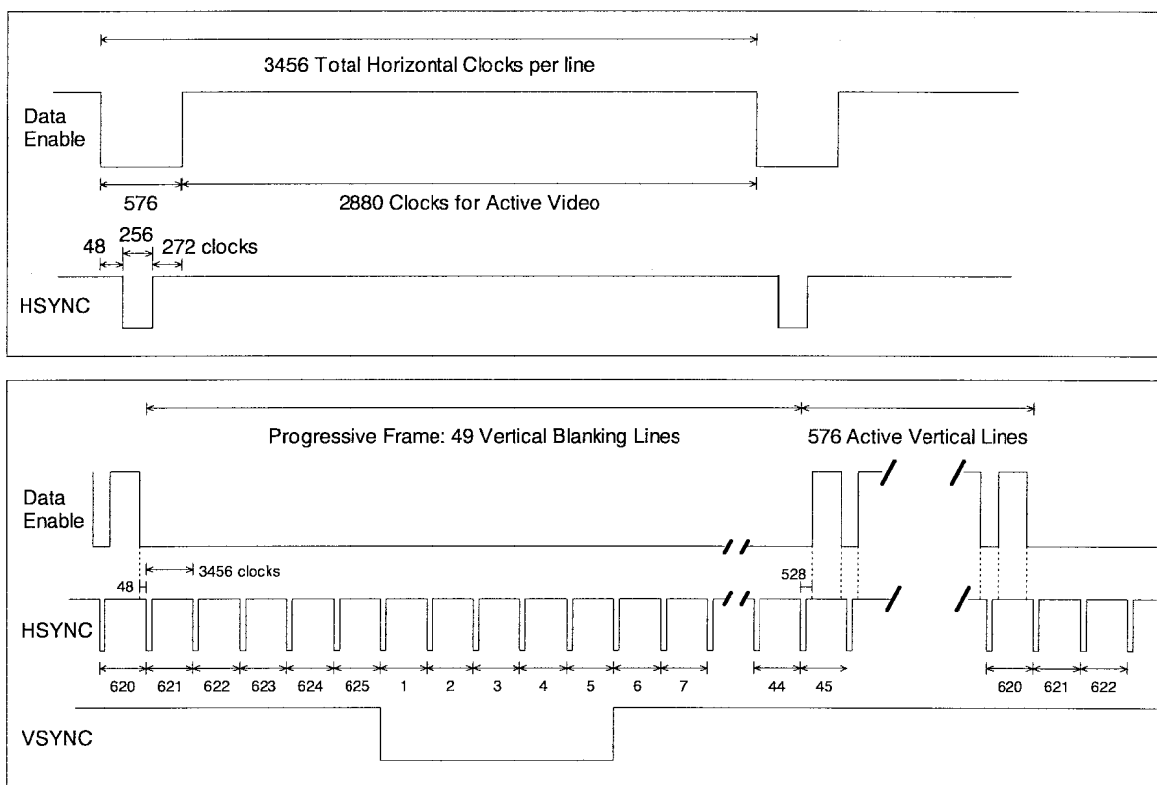
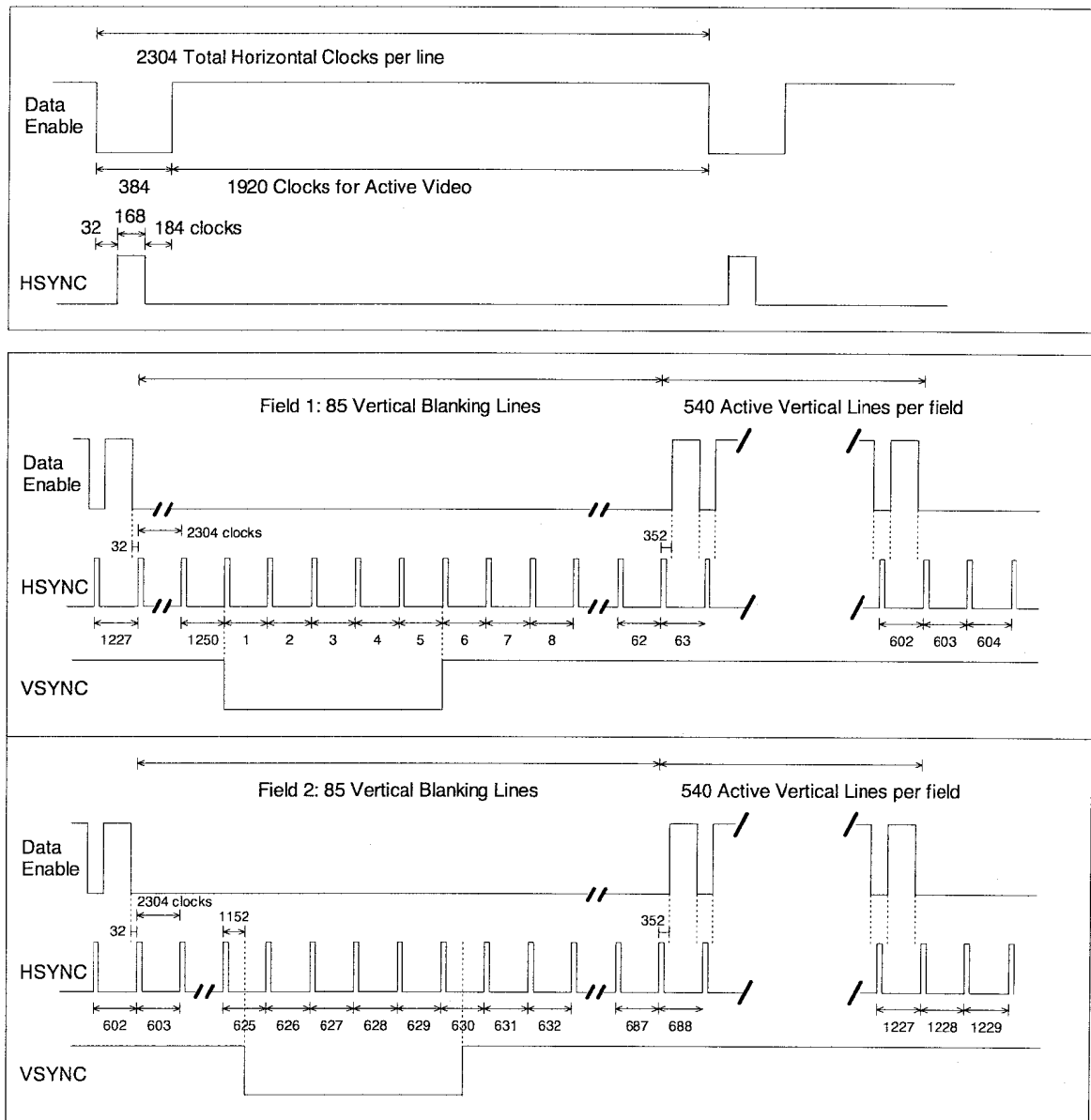

Figure 24 Timing Parameters for 2880x576p @ 50 Hz

**4.26 1920x1080i (1250 Total) @ 50 Hz (Format 39)**

This format is available only in a 16:9 aspect ratio. The format is specifically designed for use with 31.25KHz constant horizontal rate cathode-ray tube televisions.

The format has a total of 1250 vertical lines - instead of the normal 1125 found in SMPTE 274 based timings. It has a frame, which is split into two unequal fields of 624.5 and 625.5 lines. The format is specifically designed for use with special 31.25 kHz constant horizontal rate cathode-ray tube televisions and should be used with caution. Timing is similar to the 1250/50/2:1 system that described in Australian AS 4933.1-2005 standard. See Figure 25 for details.

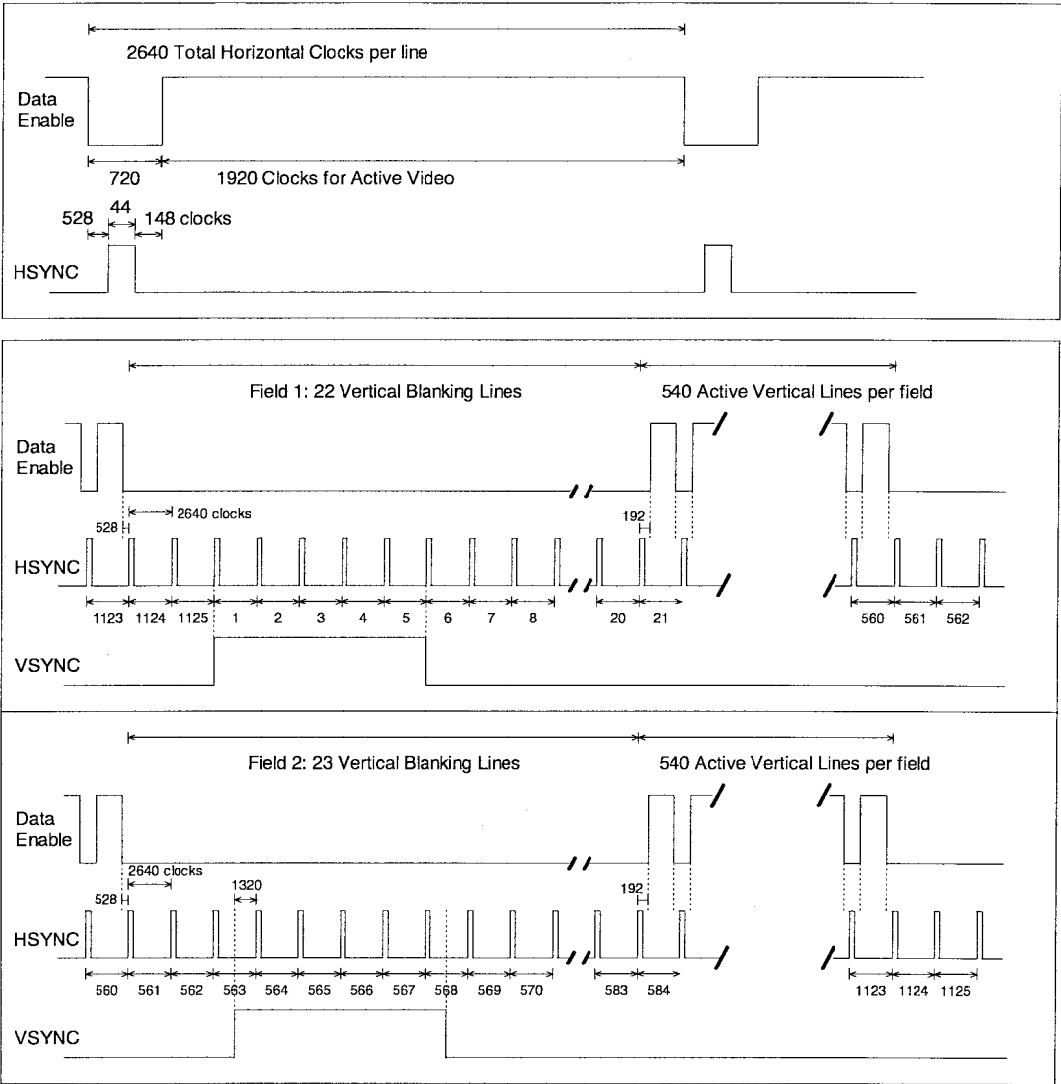

**Figure 25 Timing Parameters for 1920x1080i (1250 Total) @ 50 Hz**



**4.27 1920x1080i @ 100 Hz (Format 40)**

This is a high frame rate version of the video format described in Section 4.8. This format is available only in a 16:9 aspect ratio. See Figure 26.



**Figure 26 Timing Parameters for 1920x1080i @ 100 Hz**

**4.28 1280x720p @ 100 Hz (Format 41)**

This is a high frame rate version of the video format described in Section 4.7. This format is available only in a 16:9 aspect ratio. See Figure 27

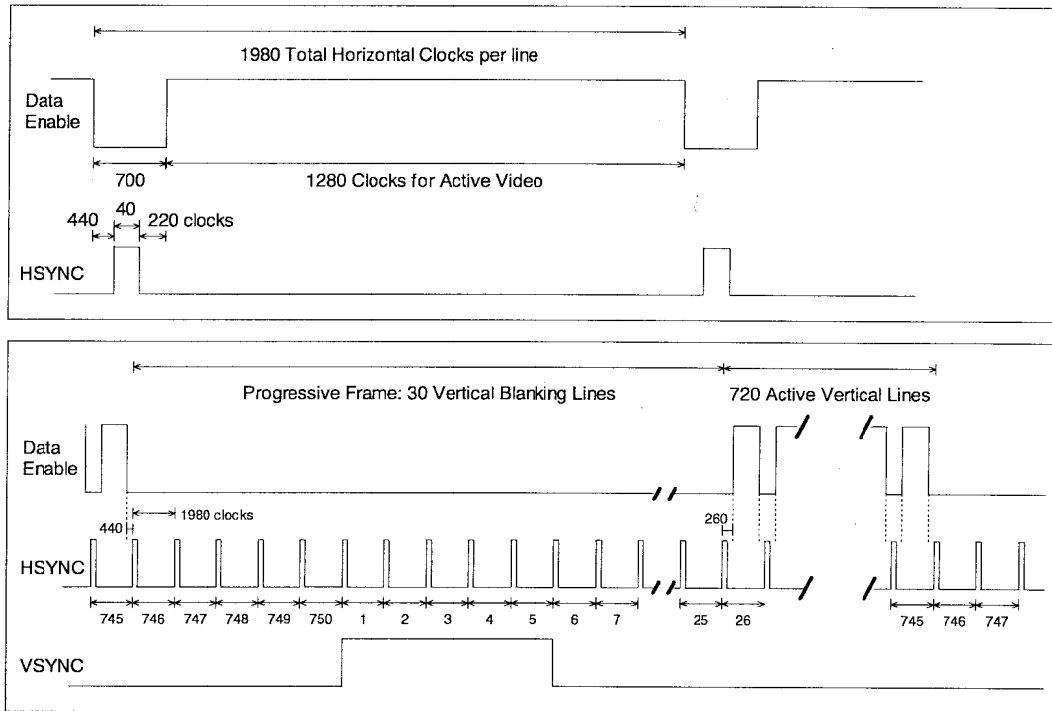

**Figure 27 Timing Parameters for 1280x720p @ 100 Hz**

**4.29 720x576p @ 100 Hz (Formats 42 and 43)**

This is a high frame rate version of the video format described in Section 4.9. This format timing can use either 4:3 or 16:9 aspect ratio. See Figure 28.

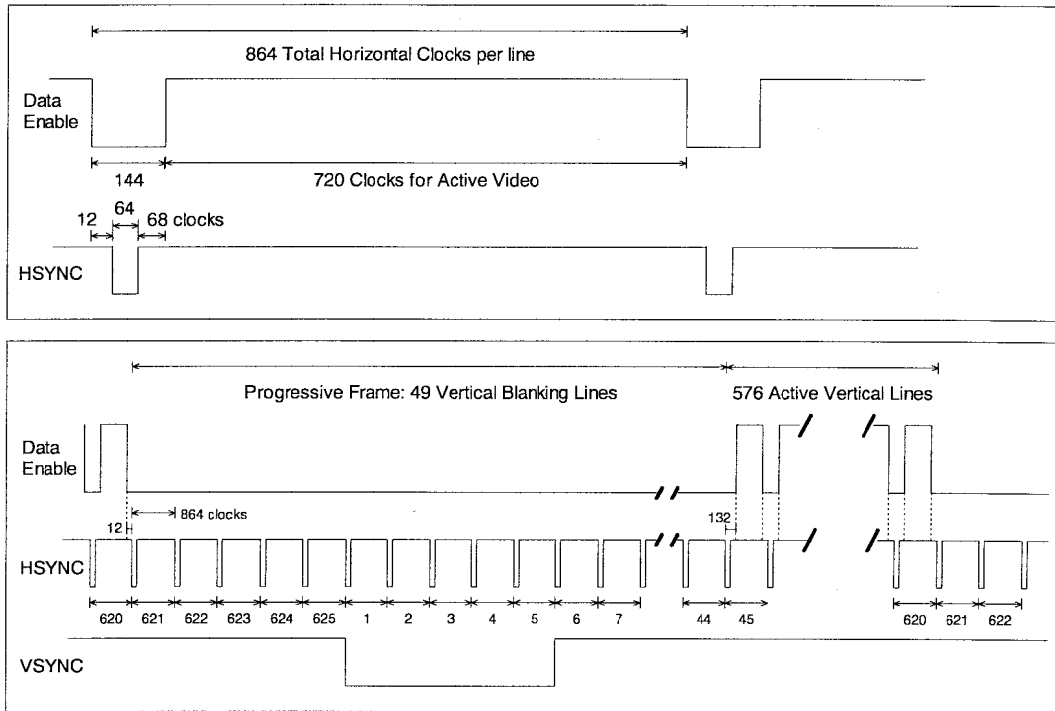

**Figure 28 Timing Parameters for 720x576p @ 100 Hz**

**4.30 720(1440)x576i @ 100 Hz (Formats 44 and 45)**

This is a high frame rate version of the video format described in Section 4.10. This format assumes the pixels are double clocked. This format timing can use 4:3 or 16:9 aspect ratio. See Figure 29.

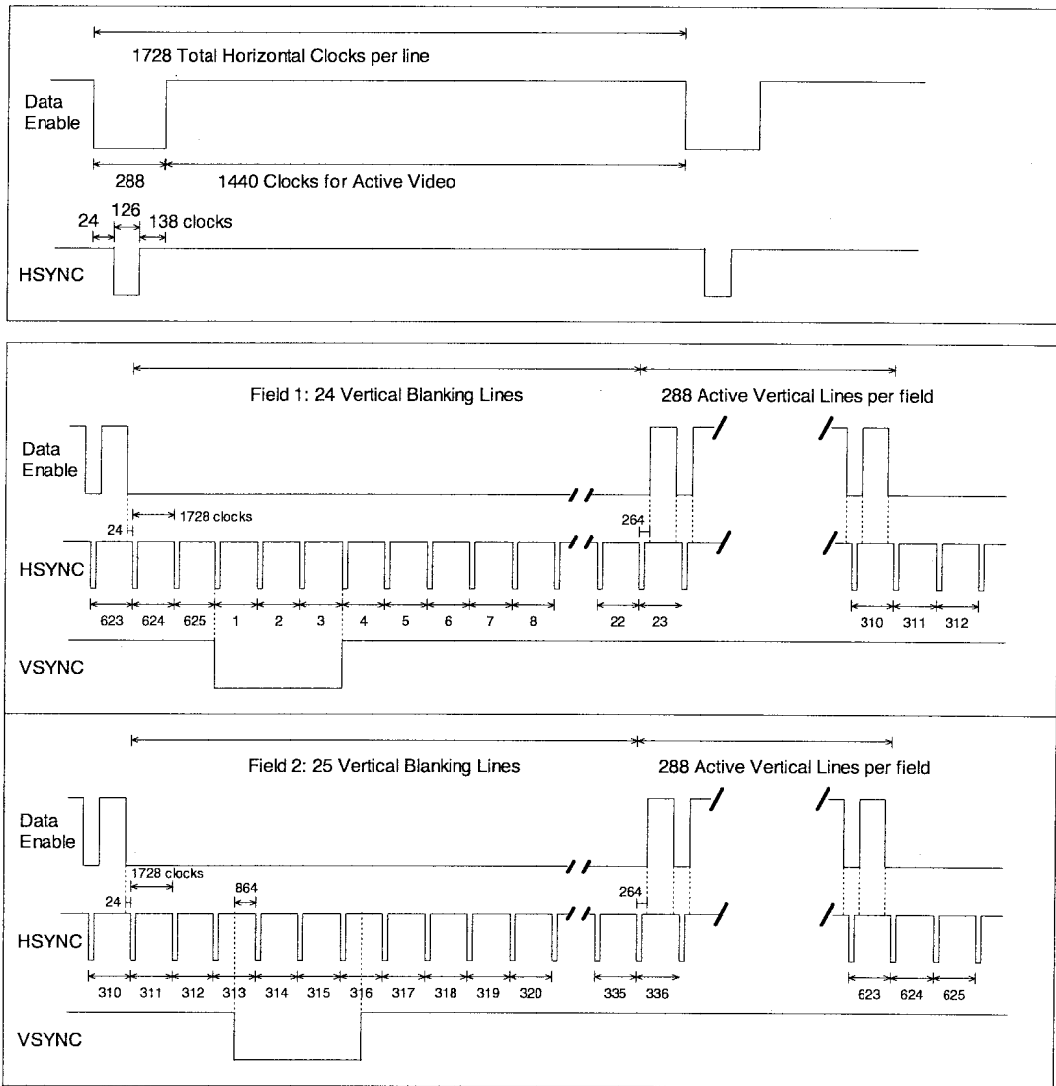

**Figure 29 Timing Parameters for 720(1440)x576 @ 100 Hz**

**4.31 1920x1080i @ 119.88/120 Hz (Format 46)**

This is a high frame rate version of the video format described in Section 4.4. This format is available only in a 16:9 aspect ratio. See Figure 30.

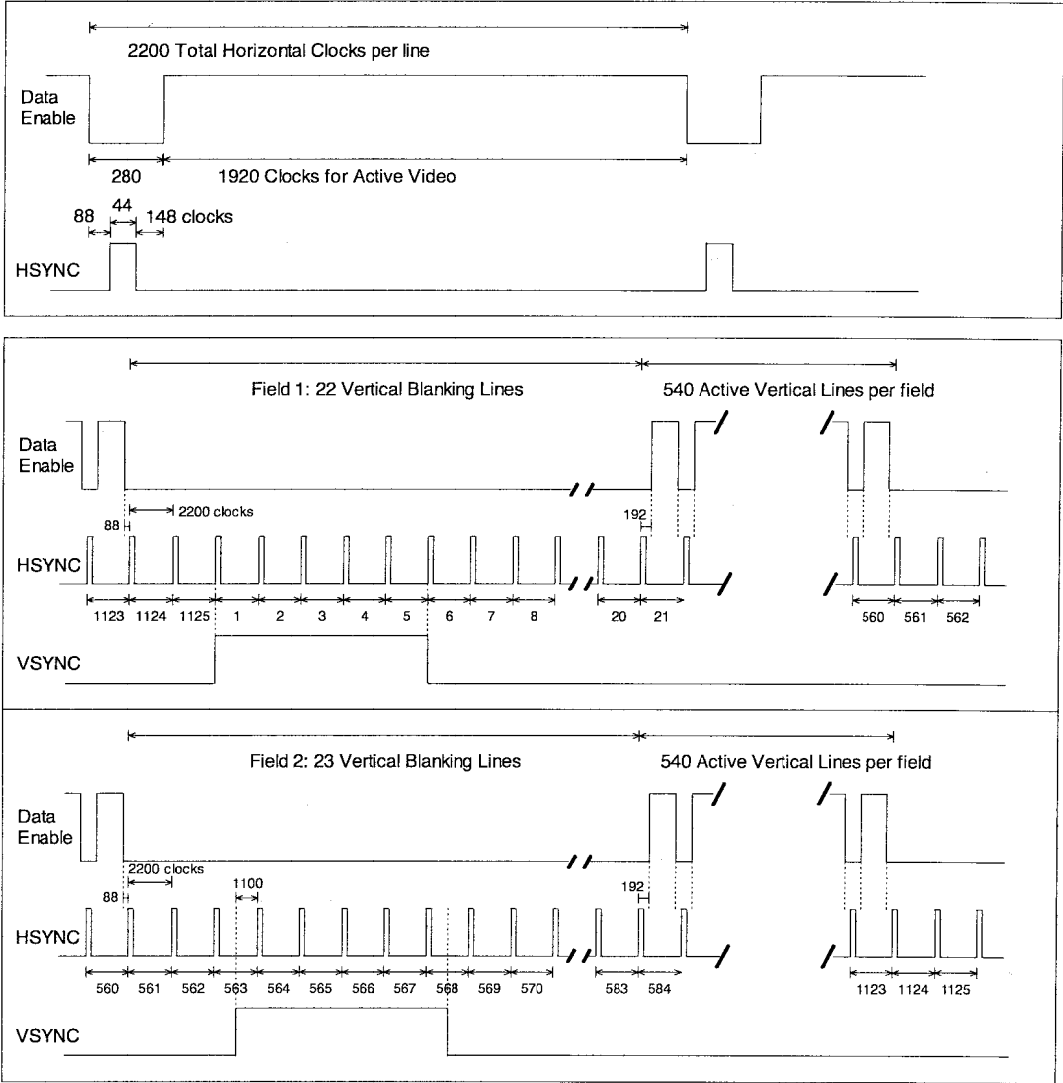

**Figure 30 Timing Parameters for 1920x1080i @ 119.88/120 Hz**

**4.32 1280x720p @ 119.88/120 Hz (Format 47)**

This is a high rate version of the video format described in Section 4.3. This format is available only in a 16:9 aspect ratio. See Figure 31.

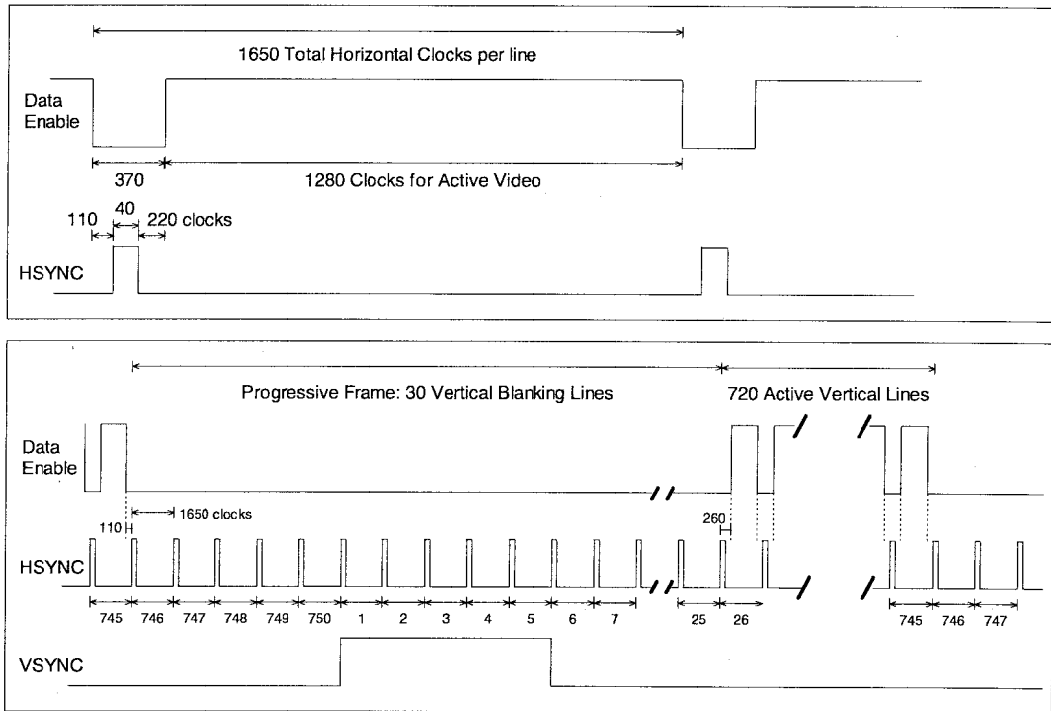

**Figure 31 Timing Parameters for 1280x720p @ 119.88/120 Hz**

**4.33 720x480p @ 119.88/120 Hz (Formats 48 and 49)**

This is a high frame rate version of the video format described in Section 4.5. This format timing can use either 4:3 or 16:9 aspect ratio. See Figure 32.

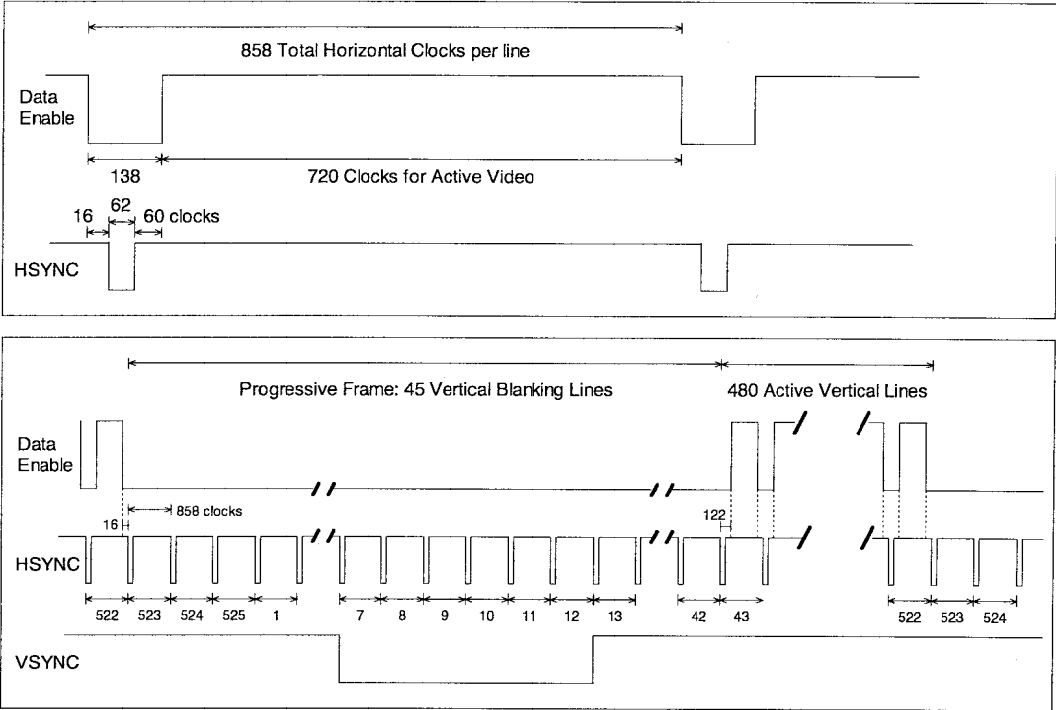

**Figure 32 Timing Parameters for 720x480p @ 119.88/120 Hz**

**4.34 720(1440)x480i @ 119.88/120 Hz (Formats 50 and 51)**

This is a high frame rate version of the video format described in Section 4.6. This format assumes the pixels are double clocked. This format timing can use 4:3 or 16:9 aspect ratio. See Figure 33.

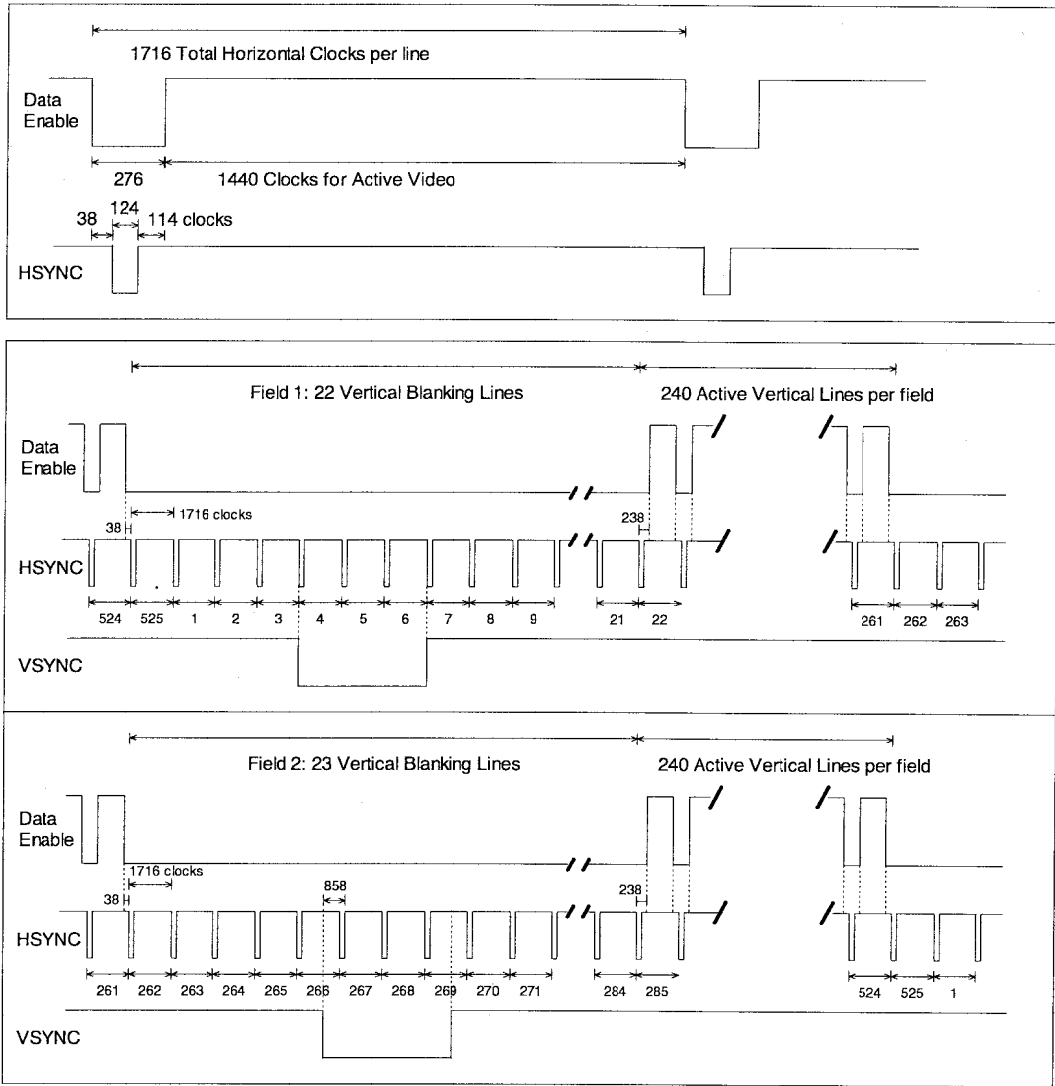
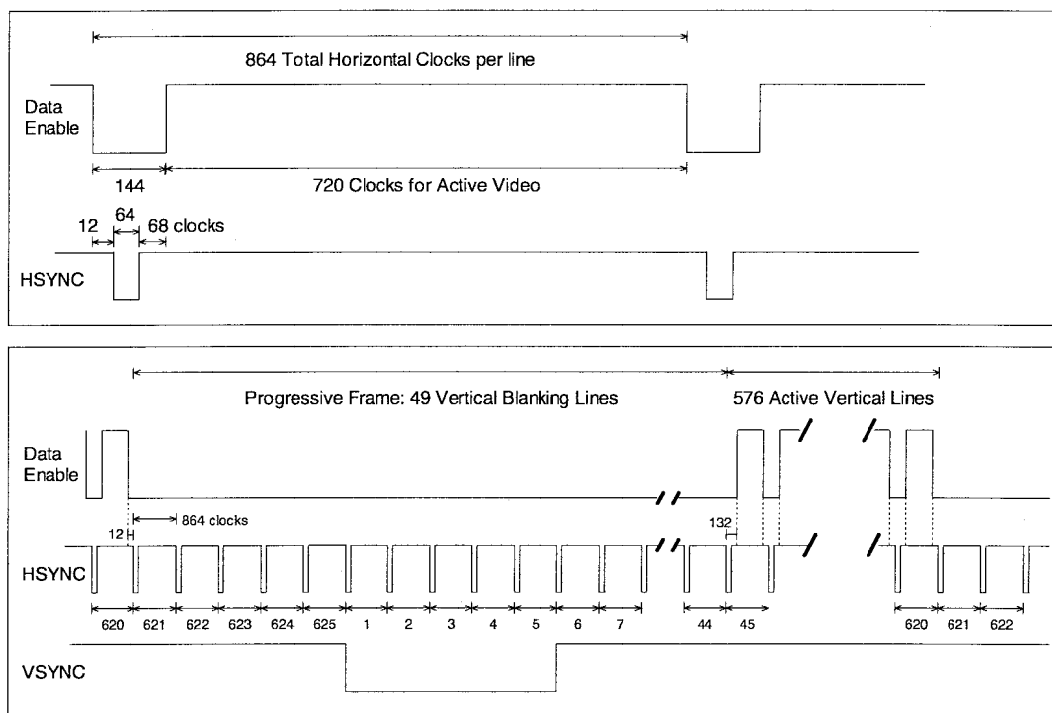

**Figure 33 Timing Parameters for 720(1440)x480i @ 119.88/120 Hz**



**4.35 720x576p @ 200 Hz (Formats 52 and 53)**

This is a high frame rate version of the video format described in Section 4.9. This format timing can use either 4:3 or 16:9 aspect ratio. See Figure 34.



**Figure 34 Timing Parameters for 720x576p @ 200 Hz**

**4.36 720(1440)x576i @ 200 Hz (Formats 54 and 55)**

This is a high frame rate version of the video format described in Section 4.10. This format assumes the pixels are double clocked. This format timing can use 4:3 or 16:9 aspect ratio.

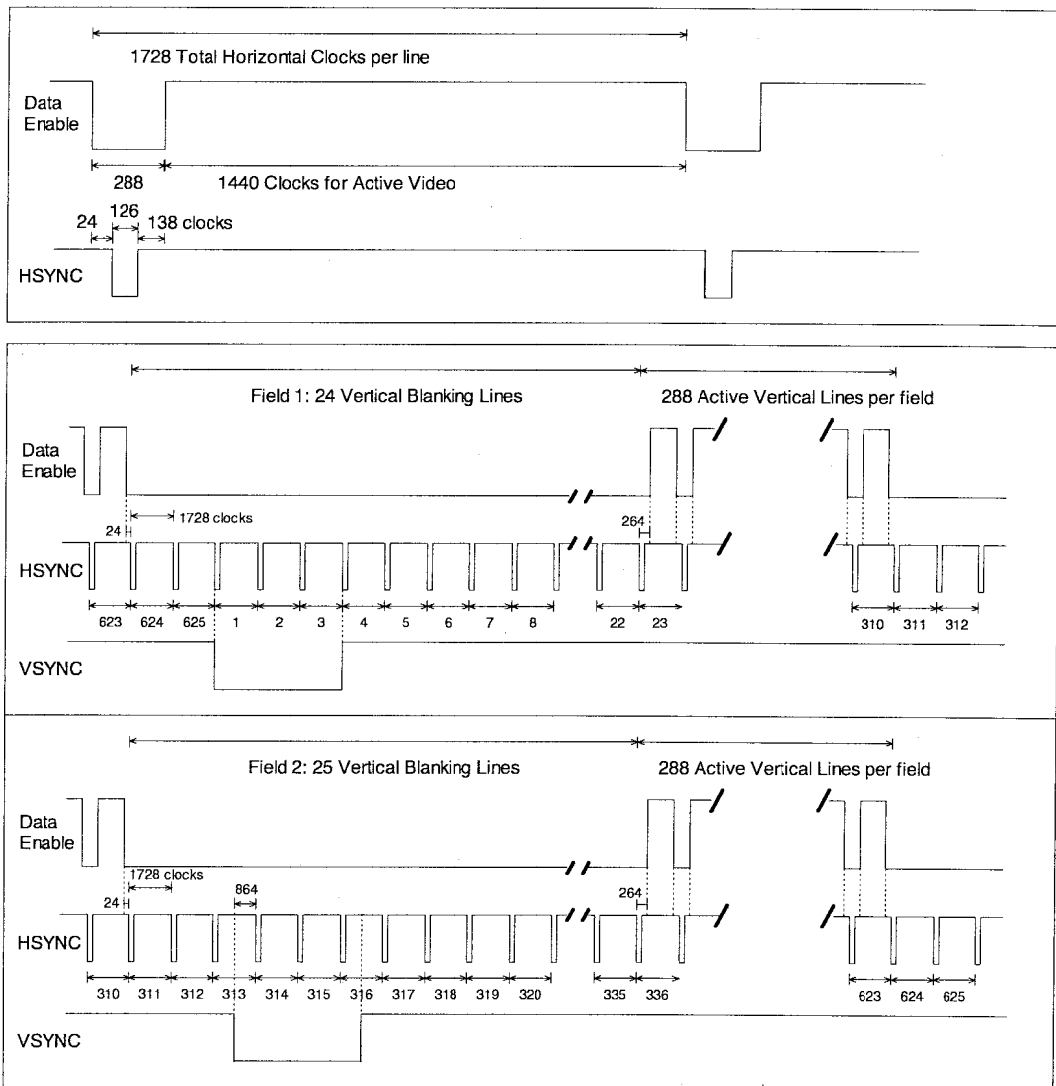

**Figure 35 Timing Parameters for 720(1440)x576i @ 200 Hz**

**4.37 720x480p @ 239.76/240 Hz (Formats 56 and 57)**

This is a high frame rate version of the video format described in Section 4.5. This format timing can use either 4:3 or 16:9 aspect ratio. See Figure 36.

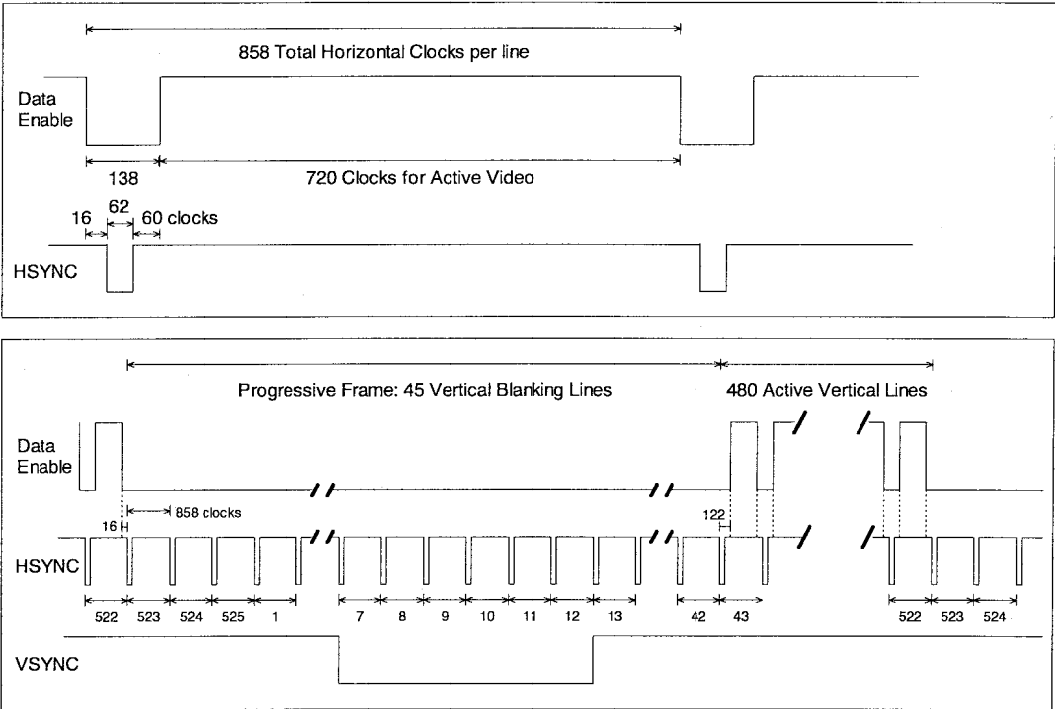

**Figure 36 Timing Parameters for 720x480p @ 239.76/240 Hz**

**4.38 720(1440)x480i @ 239.76/240 Hz (Formats 58 and 59)**

This is a high frame rate version of the video format described in Section 4.6. This format assumes the pixels are double clocked. This format timing can use 4:3 or 16:9 aspect ratio. See Figure 37.

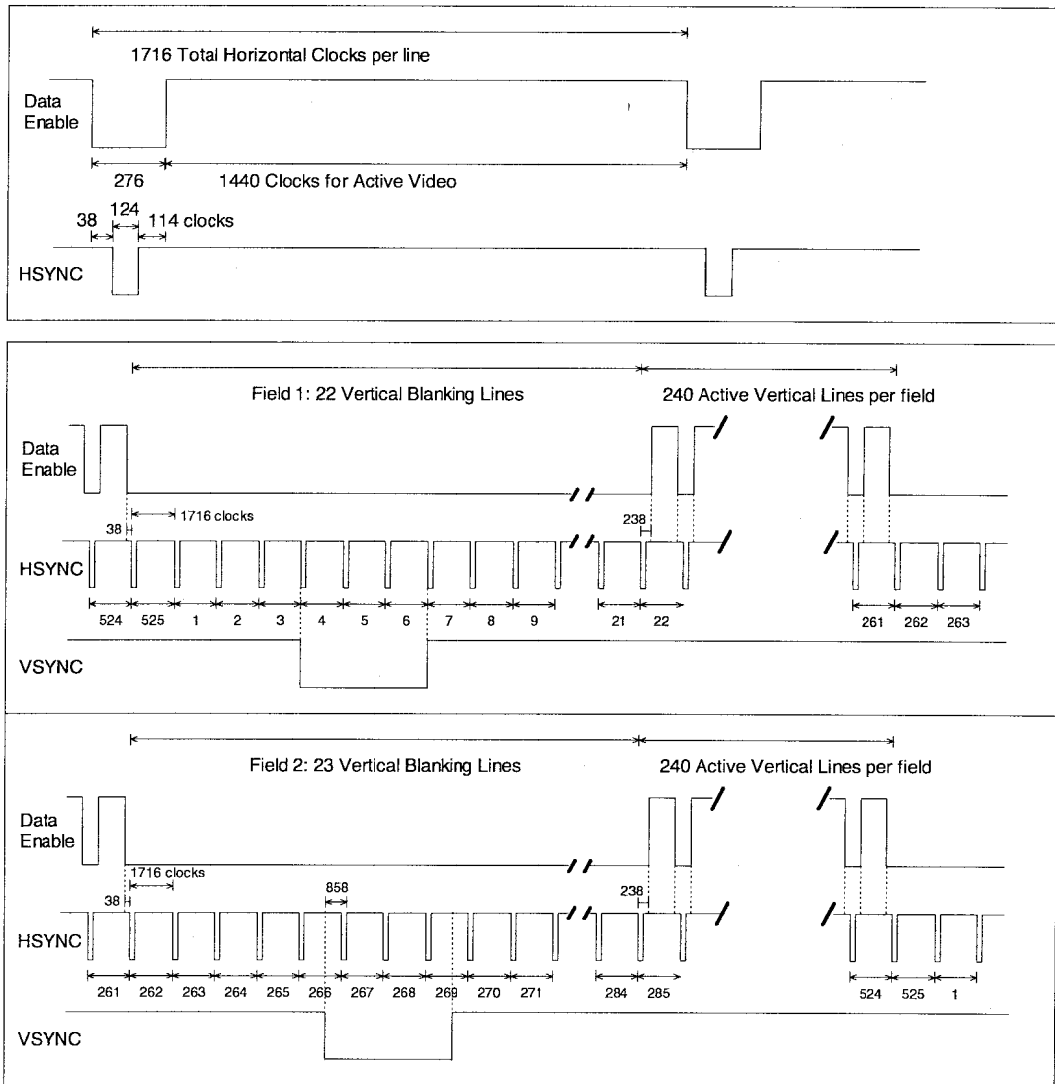

**Figure 37 Timing Parameters for 720(1440)x480i @ 239.76/240 Hz**

**5 Colorimetry and Quantization**

This interface shall be capable of supporting RGB (red, green, and blue), with encoding parameters based on the format. The interface may optionally support  $YCbCr$ .

### 5.1 480p, 480i, 576p, 576i, 240p, and 288p

The color space used by the 480-line, 576-line, 240-line, and 288-line formats will likely be based on SMPTE 170M [1].<sup>4</sup>

ITU-R BT.601-5 Section 3.5 [5] (or CEA-770.2-C Section 3.3 [19]) shall be used for any color space conversion needed in the course of processing unless a different colorimetry is specified in the Auxiliary Video Information InfoFrame.

The encoding parameter values shall be as defined in Table 3 of ITU-R BT.601-5 [5] and are summarized below:

The coding shall be 8-bit coding (scale of 0 to 255). R, G, B, and Y signals shall have 220 quantization levels with the black level corresponding to level 16 and the peak white level corresponding to level 235. The signal level may occasionally move beyond level 235.  $C_B C_R$  signals shall have 225 quantization levels with a zero level corresponding to digital level 128 and the full range corresponding with 16 to 240. For R, G, B, Y,  $C_B$ ,  $C_R$  signals, 0 and 255 are reserved and should not be considered video.

VGA and other PC video formats should use all 256 quantization levels.

### 5.2 1080i, 1080p, and 720p

The color space used by the high definition formats will likely be based on ITU-R BT.709-5 [6].

ITU-R BT.709-5 Part 1, Section 4 [6] (or CEA-770.3-C Sections 5.4-5.7 [20]) shall be used for any color space conversion needed in the course of processing unless a different colorimetry is specified in the AVI.

The digital representation shall be as defined in Part 1, Section 6.10 of ITU-R BT.709-4 and is summarized below:

The coding shall be 8-bit coding (scale of 0 to 255). R, G, B, and Y signals shall have 220 quantization levels with the black level corresponding to level 16 and the peak white level corresponding to level 235. The signal level may occasionally move beyond level 235.  $C_B C_R$  signals shall have 225 quantization levels with a zero level corresponding to digital level 128 and full range corresponding with 16 to 240. For R, G, B, Y,  $C_B$ ,  $C_R$  signals, 0 and 255 are reserved and should not be considered video.

### 5.3 Recommendations on Conversions to/from Analog Signals

If the digital video signal is converted to an analog signal in the sink device, it is recommended that for RGB or Y, the black level (i.e., sync level and blanking level) should be aligned with the video portion of the signal at digital levels 16 and the white level at digital level 235, such that the full range of the digital to analog converted signal is the same as the actual video.<sup>5</sup> This means that zero analog level (0.0 IRE) should be associated with digital level 16. Digital levels 1 - 15 (undershoot region) and level 235 - 254 (overshoot region) are recommended to be passed through the digital to analog converter; however, full range of the analog signal should be aligned with 16-235 since it is expected that essential video is in the 16-235 range. For the 640x480 format (VGA), there may be video at these levels; it is recommended that the full 0-255 range be displayed for this format.

If the digital video signal is converted to an analog signal, it is recommended that for the  $C_B C_R$  portion of the  $Y C_B C_R$  digital signal ( $P_B$ ,  $P_R$  for analog signal), the clamping level (sync level and blanking level) should be aligned with digital level 128 and the full range of the analog signal should be aligned with

<sup>4</sup> The service provider (e.g., cable, DBS, terrestrial, etc.) is expected to signal to the source device (receiver, video card, etc.) via its digital Transport Stream, which color space is being transmitted and associated with the video content.

<sup>5</sup> RGB signals have the same notation in the digital and analog domains. Typically, Y,  $C_B$ ,  $C_R$  notation is used for digital domains; and Y,  $P_B$ ,  $P_R$  is used for analog domains.

digital level 16 to 240. However, the digital to analog converter may pass the full 1-254 range or may pass levels 16-254.

### 6 Auxiliary Information Carried from Source to DTV Monitor

Various types of auxiliary data can be carried from the Source to the DTV Monitor using InfoFrames. This section describes the InfoFrames that have been defined so far.

The actual mechanism for carrying these InfoFrames may vary depending on the digital interface being used<sup>6</sup>.

**NOTE**—Previous versions of CEA-861-C relied on a Revision number in the included CEA Extension to indicate whether the DTV Monitor could accept InfoFrames. Due to a significant number of DVI (not InfoFrame-capable) sink devices having the Revision Number set to 3, indicating support of InfoFrames, and not being capable of doing so, it is necessary to deprecate this requirement and thus, source and sink devices shall not rely on the Revision Number. Sink devices shall now declare InfoFrame capability by including an interface related (e.g. HDMI) VSDB in their EDID via CEA Extension. Source devices shall only assume InfoFrame capability, when an appropriate (e.g. HDMI) VSDB is found.

DVI does not support the transmission of any InfoFrames, independent of CEA Extension version number. CEA-861-C sink devices accept any of the InfoFrames defined here.

Five types of InfoFrames are defined in CEA-861-C (Auxiliary Video Information InfoFrame, Vendor Specific InfoFrame, Source Product Description InfoFrame, Audio InfoFrame, and MPEG Source InfoFrame). The assigned type codes for these InfoFrames are shown in Table 4. The first byte of the InfoFrame designates the type of InfoFrame while the second byte indicates the version of that particular InfoFrame. All future versions of a specific InfoFrame shall be backward compatible with previous versions. They may contain additional information, but old and new devices should be able to access and interpret the information previously present. All of the InfoFrames defined in CEA-861-C are version 1 except for the AVI InfoFrame which has a version 1 and version 2. The InfoFrame Length Field is contained in the third byte of each InfoFrame. This length field is the total number of bytes in the InfoFrame Payload. It does not include the Type, Version, or Length fields. In the case of the Vendor Specific InfoFrame, the length includes the 24-bit IEEE Registration ID, as well as any additional bytes defined by the vendor to be in the InfoFrame (see Table 5).

Info Frame Type Code	Type of InfoFrame
00 <sub>16</sub>	Reserved
01 <sub>16</sub>	Vendor Specific (defined in this Annex)
02 <sub>16</sub>	Auxiliary Video Information (defined in Section 6.2)
03 <sub>16</sub>	Source Product Description (defined in Section 6.5)
04 <sub>16</sub>	Audio (defined in Section 6.6 of this document)
05 <sub>16</sub>	MPEG Source (defined in Section 6.7 of this document)
06 <sub>16</sub> -FF <sub>16</sub>	Reserved for future

**Table 4 List of InfoFrame Type Codes**

When creating new versions of an InfoFrame, the version number shall be incremented from what it was in the previous version. New versions of any specific InfoFrame shall contain all of the fields in the

<sup>6</sup> Neither DVI 1.0 [2] nor OpenLDI 0.95 [7] contain a mechanism for transporting InfoFrames. These physical interfaces can be used to implement this standard with reduced functionality. HDMI, which is backward compatible with DVI 1.0 and contains mechanisms for transferring InfoFrames, digital audio, and YC<sub>B</sub>C<sub>R</sub> pixel data, is available and can be used to implement the full capabilities of CEA-861-C.

previous version for the purpose of backward compatibility. The length field shall always be set correctly so that DTV Monitors that don't fully understand the format of a given InfoFrame may skip to the end.

The contents of the Auxiliary Video Information InfoFrame are described in Section 6.2. The contents of the Product Description InfoFrame is described in Section 6.5. The contents of the Audio InfoFrame are described in Section 6.6. The contents of the MPEG Source InfoFrame are described in Section 6.7.

### 6.1 Vendor Specific InfoFrames

The content of the Vendor Specific InfoFrame is defined in Table 5. This InfoFrame can be used by product manufacturers or organizations that have an assigned 24-bit IEEE Registration Identifier to transport information not defined elsewhere. The Vendor Specific Payload would be defined by the organization to which the 24-bit IEEE number refers. The 24-bit IEEE number, also called "company\_id" or OUI, is sent least significant byte first. It is recommended that the Vendor Specific Payload contain a "length field" to facilitate extensibility, but this is not required.

Byte #	Field Name	Contents
n	Vendor Specific InfoFrame Type Code	01 <sub>16</sub>
n+1	Vendor Specific InfoFrame Version	01 <sub>16</sub>
n+2	L <sub>v</sub> InfoFrame Length	Total number of bytes in InfoFrame Payload including IEEE Registration ID
n+3	24 bit IEEE Registration Identifier	24 bit IEEE Registration ID <sup>7</sup> (Least Significant Byte first)
....		
n+5		
...	Vendor Specific Payload	Vendor Specific Payload
n+L <sub>v</sub> -1		

Table 5 Vendor Specific InfoFrame

### 6.2 Auxiliary Video Information (AVI) InfoFrame

The AVI is carried in the AV-stream from the source device to the DTV Monitor as an InfoFrame.

NOTE—Previous versions of CEA-861-C defined the Version 1 AVI InfoFrame. Support for version 1 has been removed from CEA-861-C.

Sources shall not use AVI InfoFrame version 1.

If the source device supports the transmission of the Auxiliary Video Information (AVI) and if it determines that the DTV Monitor is capable of receiving that information, it shall send the AVI to the DTV Monitor once per VSYNC period. The data applies to the next full frame of video data.

For DTV Monitors that support any video format with video identification code greater than 7, or that simultaneously support two different aspect ratios for the same video format timing (e.g., dual-aspect ratio timings such as 720x480p), the DTV Monitor shall be able to receive and decode the AVI InfoFrame described in this Section. Simultaneous support of timings available in two different aspect ratios shall be indicated by listing both formats in the EDID data structure at the same time.

<sup>7</sup> The IEEE Registration Authority maintains a database of 24-bit numbers uniquely assigned to organizations and vendors. Any organization or vendor that wishes to define a vendor specific InfoFrame shall obtain a registration ID (also known as vendor ID, organizationally unique ID, or company ID) from:

Institute of Electrical and Electronic Engineers, Inc.  
IEEE Registration Authority  
c/o IEEE Standards Association  
445 Hoes Lane  
Piscataway, NJ 08855-1331

If a Dual Aspect Ratio DTV Monitor is receiving a video format timing for which it has declared support for both picture aspect ratios in EDID and the source device has indicated the picture aspect ratio by including the AVI in the video stream, then the DTV Monitor shall display the picture in the aspect ratio that has been indicated by the source device in the AVI. If the source device does not support transmission of the AVI, then the source device shall provide the video to the DTV monitor in the preferred aspect ratio as explained in Section 4.1.

If, for some reason, an indication is received that conflicts with the video format being received (e.g., the source device indicates 4:3 but sends the 1920x1080i format), then the DTV Monitor shall use the picture aspect ratio that is associated with the format being sent.

If a DTV Monitor supports  $YCbCr$  (in addition to RGB), then it shall include the version 3 CEA Extension with at least one of the  $YCbCr$  bits set and shall be capable of receiving the AVI. If no AVI is being sent from the source device, then the DTV Monitor shall assume the video data is RGB.

The information on "Active Format Aspect Ratio," bar widths, overscan/underscan, non-uniform picture scaling, and colorimetry is information that can be used by the DTV Monitor to improve the picture. Use of this information by the DTV Monitor is optional. If this information is present at the source device and valid,<sup>8</sup> and if the DTV Monitor is capable of receiving the AVI, it is required that this information be sent.

For DTV Monitors not capable of receiving AVI, the DTV Monitor shall not declare in its EDID data structure more than one format that is the same except for picture aspect ratio at the same time.

If an AVI InfoFrame is sent from a source box to a DTV Monitor and if one of the video formats listed in CEA-861-C is being sent, then the Video Identification Code shall be set correctly. If a video format not listed in CEA-861-C is sent, then the Video Identification Code shall be set to 0. In many cases, the sink device will be able to determine the video format from the video itself. If the Video Identification Code being received in the AVI does not match the video being received, then the sink device shall ignore the Video Identification Code and process the video correctly.

### 6.3 Format of Version 1 AVI InfoFrame

The Version 1 AVI InfoFrame was originally defined in CEA-861-A but will never be used. For historical purposes, the Version 1 AVI InfoFrame is shown in Table 6.

---

<sup>8</sup> The data may not be valid if, for example, the stream was converted from an analog signal with no reliable aspect ratio or format information.



InfoFrame Type Code	InfoFrame Type = 02 <sub>16</sub>							
InfoFrame Version Number	Version = 01 <sub>16</sub>							
Length of AVI InfoFrame	Length of AVI InfoFrame (13)							
Data Byte 1	Rsvd=0	Y1	Y0	A0	B1	B0	S1	S0
Data Byte 2	C1	C0	M1	M0	R3	R2	R1	R0
Data Byte 3	Reserved for Future (shall be 0)						SC1	SC0
Data Byte 4	Reserved for Future (shall be 0)							
Data Byte 5	Reserved for Future (shall be 0)							
Data Byte 6	Line Number of End of Top Bar (lower 8 bits)							
Data Byte 7	Line Number of End of Top Bar (upper 8 bits)							
Data Byte 8	Line Number of Start of Bottom Bar (lower 8 bits)							
Data Byte 9	Line Number of Start of Bottom Bar (upper 8 bits)							
Data Byte 10	Pixel Number of End of Left Bar (lower 8 bits)							
Data Byte 11	Pixel Number of End of Left Bar (upper 8 bits)							
Data Byte 12	Pixel Number of Start of Right Bar (lower 8 bits)							
Data Byte 13	Pixel Number of Start of Right Bar (upper 8 bits)							

**Table 6 Auxiliary Video Information InfoFrame Format (Version 1)**

#### 6.4 Format of Version 2 AVI InfoFrame

The format of the Version 2 AVI InfoFrame is backward compatible with Version 1. Because of this, all of the fields that were contained in the Version 1 AVI InfoFrame are also contained in the Version 2 AVI InfoFrame. Their purpose and use remain unchanged. All fields of the Version 2 AVI are described here. The Version 2 AVI InfoFrame is shown in Table 7.

InfoFrame Type Code	InfoFrame Type = 02 <sub>16</sub>							
InfoFrame Version Number	Version = 02 <sub>16</sub>							
Length of AVI InfoFrame	Length of AVI InfoFrame (13)							
Data Byte 1	F7=0	Y1	Y0	A0	B1	B0	S1	S0
Data Byte 2	C1	C0	M1	M0	R3	R2	R1	R0
Data Byte 3	Reserved (shall be 0)						SC1	SC0
Data Byte 4	Rsvd=0	VIC6	VIC5	VIC4	VIC3	VIC2	VIC1	VIC0
Data Byte 5	Reserved (shall be 0)				PR3	PR2	PR1	PR0
Data Byte 6	Line Number of End of Top Bar (lower 8 bits)							
Data Byte 7	Line Number of End of Top Bar (upper 8 bits)							
Data Byte 8	Line Number of Start of Bottom Bar (lower 8 bits)							
Data Byte 9	Line Number of Start of Bottom Bar (upper 8 bits)							
Data Byte 10	Pixel Number of End of Left Bar (lower 8 bits)							
Data Byte 11	Pixel Number of End of Left Bar (upper 8 bits)							
Data Byte 12	Pixel Number of Start of Right Bar (lower 8 bits)							
Data Byte 13	Pixel Number of Start of Right Bar (upper 8 bits)							

**Table 7 Auxiliary Video Information (AVI) InfoFrame Format (Version 2)**

Data Byte 1 (Table 8) contains bits that describe overscan/underscan (e.g., computer graphics or video), two bits to indicate whether optional YC<sub>B</sub>C<sub>R</sub> is being used, and bits that indicate the presence of valid active format and/or bar information. If the bar information and the active format information do not agree, then the bar information shall take precedence.

F7	Future Use, all Zeros	Y1	Y0	RGB or YCbCr	A0	Active Format Information Present	B1	B0	Bar Info	S1	S0	Scan Information
0		0	0	RGB (default)	0	No Data	0	0	Bar Data not valid	0	0	No Data
		0	1	YCbCr 4:2:2	1	Active Format Information valid	0	1	Vert. Bar Info valid	0	1	Overscanned (television)
		1	0	YCbCr 4:4:4			1	0	Horiz. Bar Info Valid	1	0	Underscanned (Computer)
		1	1	Future			1	1	Vert. and Horiz. Bar Info valid	1	1	Future

**Table 8 AVI InfoFrame Data Byte 1**

Data Byte 2 (Table 9) contains bits that describe colorimetry, picture aspect ratio, and the active format information.

C1	C0	Colorimetry	M1	M0	Picture Aspect Ratio	R3	R2	R1	R0	Active Format Aspect Ratio
0	0	No Data	0	0	No Data	1	0	0	0	Same as picture aspect ratio
0	1	SMPTE 170M [1] ITU601 [5]	0	1	4:3	1	0	0	1	4:3 (Center)
1	0	ITU709 [6]	1	0	16:9	1	0	1	0	16:9 (Center)
1	1	Future	1	1	Future	1	0	1	1	14:9 (Center)
other values										Per DVB AFD active_format field in [3].

Table 9 AVI InfoFrame Data Byte 2

Table 10 illustrates the terminology and examples of common aspect ratio information that can be communicated from a source device to a display device using this standard. It illustrates some of the possibilities for the two standard picture aspect ratios (4:3 and 16:9) with the active format over the picture. The "active format" codes shall be coded in accordance with the Active Format Description<sup>9</sup> (AFD) in the DVB specification[3].<sup>10</sup> All of the active format codes defined in [3] are reproduced in informative Annex H of this standard.

<sup>9</sup> Note that the use of the term "active" in the "Active Format Description" differs from how it is used in other places of this standard and documents referenced by this standard. Active usually refers to any and all addressable pixels. In this case, Active Format refers to the useful information within this active area.

<sup>10</sup> DVB [3] supports 10 active formats. Other active formats can be supported by the bar information contained in bytes 6-13 of the AVI InfoFrame.

active format		illustration of described format	
Value	Description	4:3 Picture AR	16:9 Picture AR
1000	Same as Picture		
1001	4:3 (center)		
1010	16:9 (center)		
1011	14:9 (center)		

Table 10 Common Active Formats

Data Byte 3 contains information on whether the picture has been scaled in a non-uniform way (i.e., unequal along horizontal and vertical dimensions) prior to transmission to the DTV Monitor. (See Table 11.) The Non-uniform Picture Scaling bits shall be set if the source device scales the picture or has determined that scaling has been performed in a specific direction. If the picture has been stretched or shrunk in a uniform way (i.e., equally along both dimensions), then the bits should not be set. These bits are present to help avoid situations such as the one illustrated in Annex I. All bits labeled as F# are reserved for the future and shall be set to 0.

F7	F6	F5	F4	F3	F2	Future Use, All zeros	SC1	SC0	Non-uniform Picture Scaling
0	0	0	0	0	0		0	0	No Known non-uniform Scaling
							0	1	Picture has been scaled horizontally
							1	0	Picture has been scaled vertically
							1	1	Picture has been scaled horizontally and vertically

Table 11 AVI InfoFrame Data Byte 3

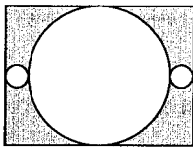
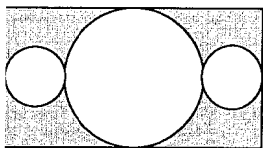
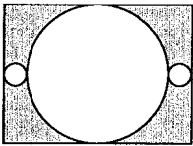
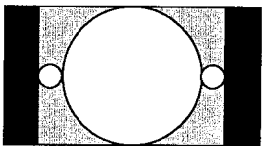
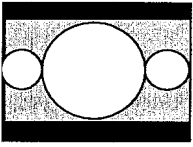
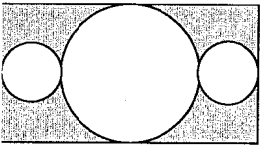
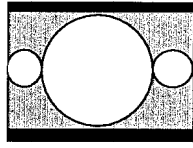
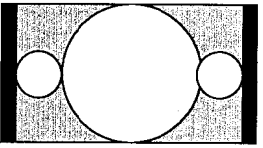
Data Byte 4 contains a Video Identification Code. In most cases, the video format can be uniquely determined from the video format timing itself. However, if the source box is sending one of the video formats defined in this document, then it shall set this field to the proper code. If this field is used and if it is inconsistent with the video format being received, then it shall be ignored by the DTV Monitor. If the picture aspect ratio implied by this field does not agree with the picture aspect ratio communicated in Data Byte 2, then Data Byte 2 shall take precedence. The codes associated with each video format are shown in Table. These same codes are used in the Short Video Descriptors used in the Version 3 CEA Extension, which is described in Section 7.5. If the source device needs to convey "no information" regarding the video format (perhaps it is sending a proprietary format that was defined using the EDID Detailed Timing Descriptor in the DTV Monitor), then this field shall be set to 0.

Data Byte 5 contains the pixel repetition factor, which indicates to the DTV Monitor how many repetitions of each unique pixel are transmitted for the optional (2880)x480i/240p or (2880)x576i/288p or 1440x480p or 1440x576p formats. These are the only formats that allow for a range of values. In those cases, the AVI shall be sent to the DTV Monitor with this field set correctly and the DTV Monitor shall properly interpret it. As with all video formats, the source box shall read the EDID to determine if the specific format is supported before it sends it.

If the Version 2 AVI InfoFrame is sent, then the Pixel Repeat field shall be set correctly no matter what video format is being transmitted. In non-repeated formats, this value is 0. For pixel-repeated formats, this value indicates the number of pixels that shall be decimated by the receiver or repeated depending on the signal process. In all cases, the first transmitted pixel data of a line of video is unique. Subsequent pixels will be repetition(s) of the previous pixel if pixel repetition is used. The values for Pixel Repeat are shown in Table 12.

PR3	PR2	PR1	PR0	Pixel Repetition Factor
0	0	0	0	No Repetition (i.e., pixel sent once)
0	0	0	1	pixel sent 2 times (i.e., repeated once)
0	0	1	0	pixel sent 3 times
0	0	1	1	pixel sent 4 times
0	1	0	0	pixel sent 5 times
0	1	0	1	pixel sent 6 times
0	1	1	0	pixel sent 7 times
0	1	1	1	pixel sent 8 times
1	0	0	0	pixel sent 9 times
1	0	0	1	pixel sent 10 times
0Ah-0Fh				Reserved

Table 12 AVI InfoFrame Pixel Repetition Field, Data Byte 5

A list of allowable Pixel Repeat values for each CEA format timing is shown in Table 13. Note that this characteristic is independent of Picture Aspect Ratio.

Video Codes	Video Description	Valid Pixel Repeat Values
1	640X480p @ 59.94/60Hz	No Repetition
2, 3	720X480p @ 59.94/60Hz	No Repetition
4	1280X720p @ 59.94/60Hz	No Repetition
5	1920X1080i @ 59.94/60Hz	No Repetition
6, 7	720(1440)X480i @ 59.94/60Hz	pixel sent 2 times
8, 9	720(1440)X240p @ 59.94/60Hz	pixel sent 2 times
10, 11	2880X480i @ 59.94/60Hz	pixel sent 1 to 10 times
12, 13	2880X240p @ 59.94/60Hz	pixel sent 1 to 10 times
14, 15	1440X480p @ 59.94/60Hz	Pixel sent 1 to 2 times
16	1920X1080p @ 59.94/60Hz	No Repetition
17, 18	720X576p @ 50Hz	No Repetition
19	1280X720p @ 50Hz	No Repetition
20	1920X1080i @ 50Hz	No Repetition
21, 22	720(1440)X576i @ 50Hz	pixel sent 2 times
23, 24	720(1440)X288p @ 50Hz	pixel sent 2 times
25, 26	2880X576i @ 50Hz	pixel sent 1 to 10 times
27, 28	2880X288p @ 50Hz	pixel sent 1 to 10 times
29, 30	1440X576p @ 50Hz	Pixel sent 1 to 2 times
31	1920X1080p @ 50Hz	No Repetition
32	1920X1080p @ 23.98/24Hz	No Repetition
33	1920X1080p @ 25Hz	No Repetition
34	1920X1080p @ 29.97/30Hz	No Repetition
35, 36	2880x480p @ 59.94/60Hz	pixel sent 1, 2 or 4 times
37, 38	2880x576p @ 50Hz	pixel sent 1, 2 or 4 times
39	1920x1080i (1250) @ 50Hz	No Repetition
40	1920x1080i @ 100Hz	No Repetition
41	1280x720p @ 100Hz	No Repetition
42	720x576p @ 100Hz	No Repetition
43	720x576p @ 100Hz	No Repetition
44	720(1440)x576i @ 100Hz	Pixel sent 2 times
45	720(1440)x576i @ 100Hz	Pixel sent 2 times
46	1920x1080i @ 119.88/120Hz	No Repetition
47	1280x720p @ 119.88/120Hz	No Repetition
48	720x480p @ 119.88/120Hz	No Repetition
49	720x480p @ 119.88/120Hz	No Repetition
50	720(1440)x480i @ 119.88/120Hz	Pixel sent 2 times
51	720(1440)x480i @ 119.88/120Hz	Pixel sent 2 times
52	720X576p @ 200Hz	No Repetition
53	720X576p @ 200Hz	No Repetition
54	720(1440)x576i @ 200Hz	Pixel sent 2 times
55	720(1440)x576i @ 200Hz	Pixel sent 2 times
56	720x480p @ 239.76/240Hz	No Repetition
57	720x480p @ 239.76/240Hz	No Repetition
58	720(1440)x480i @ 239.76/240Hz	Pixel sent 2 times
59	720(1440)x480i @ 239.76/240Hz	Pixel sent 2 times

**Table 13 Valid Pixel Repeat Values for Each Video Format Timing**

Data Bytes 6 through 13 contain the size of bars as shown in Table 7. The 8 bytes of bar data are present in the AVI whether their information is valid or not. The packets and bits are defined below.

For the purposes of the Line Number and the Pixel Number, the pixel in the upper left hand corner is considered to be in row 1, column 1. Lines and pixels are numbered consecutively as they would appear on a display.<sup>11</sup> All of the values are unsigned integers.

- a) **Line Number of End of Top Bar** - An unsigned integer value representing the last line of a horizontal letterbox bar area at the top of the picture. Zero means no horizontal bar is present at the top of the picture.
- b) **Line Number of Start of Bottom Bar** - An unsigned integer value representing the first line of a horizontal letterbox bar area at the bottom of the picture. If greater than the Maximum Vertical Active Lines of the known format, no horizontal bar is present at the bottom of the picture.
- c) **Pixel Number of End of Left Bar** - An unsigned integer value representing the last horizontal pixel of a vertical pillar-bar area at the left side of the picture. Zero means no vertical bar is present on the left of the picture.
- d) **Pixel Number of Start of Right Bar** - An unsigned integer value representing the first horizontal pixel of a vertical pillar-bar area at the right side of the picture. If greater than the Maximum Horizontal Pixels of the known format, no vertical bar is present on the right side of the picture.

#### 6.5 Source Product Description (SPD) InfoFrame

The Source Product Description (SPD) InfoFrame communicates the name and product type of the source device. This allows the user to see which device is being selected when changing inputs on the DTV Monitor.

Support of the SPD InfoFrame in the DTV Monitor is indicated by including version 3 of the CEA Extension in the DTV Monitor's EDID data structure. The transmission of this infoFrame is optional for the source device. The use of the information by the DTV Monitor is also optional. It shall not be sent more than once per video frame. If used, it is recommended that it be sent once every second.

The format of the Source Product Description InfoFrame is shown in Table 14.

---

<sup>11</sup> In this context, line numbers are not the same as the line numbers used in timing diagrams.

InfoFrame Type Code	InfoFrame Type = 03 <sub>16</sub> (new)	
InfoFrame Version Number	Version = 01 <sub>16</sub>	
Length of Source Product Description InfoFrame	Length of Source Product Description InfoFrame = 25	
Data Byte 1	0	Vendor Name Character 1 VN1 (7bit ASCII code)
Data Byte 2	0	Vendor Name Character 2 VN2
Data Byte 3	0	Vendor Name Character 3 VN3
Data Byte 4	0	Vendor Name Character 4 VN4
Data Byte 5	0	Vendor Name Character 5 VN5
Data Byte 6	0	Vendor Name Character 6 VN6
Data Byte 7	0	Vendor Name Character 7 VN7
Data Byte 8	0	Vendor Name Character 8 VN8
Data Byte 9	0	Product Description Character 1 PD1 (7-bit ASCII code)
Data Byte 10	0	Product Description Character 2 PD2
Data Byte 11	0	Product Description Character 3 PD3
Data Byte 12	0	Product Description Character 4 PD4
Data Byte 13	0	Product Description Character 5 PD5
Data Byte 14	0	Product Description Character 6 PD6
Data Byte 15	0	Product Description Character 7 PD7
Data Byte 16	0	Product Description Character 8 PD8
Data Byte 17	0	Product Description Character 9 PD9
Data Byte 18	0	Product Description Character 10 PD10
Data Byte 19	0	Product Description Character 11 PD11
Data Byte 20	0	Product Description Character 12 PD12
Data Byte 21	0	Product Description Character 13 PD13
Data Byte 22	0	Product Description Character 14 PD14
Data Byte 23	0	Product Description Character 15 PD15
Data Byte 24	0	Product Description Character 16 PD16
Data Byte 25		<b>Source Device Information</b> (see below)

Table 14 Source Product Description InfoFrame Format

The Vendor Name consists of eight 7-bit ASCII characters. The name should be left justified (i.e., first character in Data Byte 1) and all unused characters should be Null (i.e., 00<sub>16</sub>). The Vendor Name is intended to be the name of the company whose name appears on the product. The Product Description (contained in Data Bytes 9-24) consists of sixteen 7-bit ASCII characters. This code is meant to be the model number of the product and may contain a short description also (e.g., RC5240 DVD Player). Data Byte 25 consists of a code that classifies the source device. Codes for the most common types of source devices are shown in Table 15.



Code	Source Device Information
00h	unknown
01h	Digital STB
02h	DVD
03h	D-VHS
04h	HDD Video
05h	DVC
06h	DSC
07h	Video CD
08h	Game
09h	PC general
0Ah	Blu-Ray Disc (BD)
0Bh	Super Audio CD
0Ch	Reserved
...	
FFh -	

**Table 15 Source Product Description InfoFrame Data Byte 25**

### 6.6 Audio InfoFrame

The Audio InfoFrame contains information that allows for the format of the digital audio streams to be identified more quickly via out-of-band information and, for multi-channel uncompressed audio (which does not otherwise give such information), provides channel allocation information for the sink device's speakers.

If the sink device supports any digital audio, it shall be capable of receiving the Audio InfoFrame and also capable of interpreting the audio identification information in Data Bytes 1-3. Support for digital audio other than basic audio is indicated in the Version 3 (or higher) CEA Extension (see Section 7.5).

If the sink device supports multi-channel (i.e., more than 2 channels) digital audio and has included speaker placement information in EDID (see Section 7.5), it shall be able to interpret the speaker channel assignment information and down-mix information in Data Bytes 4 & 5.

If the source device supports the transmission of the Audio InfoFrame and if it determines that the DTV Monitor is capable of receiving the Audio InfoFrame (i.e., the DTV Monitor has included CEA Extension Version 3 in EDID) and digital audio, then the Audio InfoFrame, with Data Bytes 1 through 3 set correctly, shall be sent once per VSYNC period while digital audio is being sent across the interface. The data applies to the audio associated with the next full frame of video data.

If the source device is sending multi-channel uncompressed audio, then it shall also send valid speaker channel allocation information and down-mix information in Data Bytes 4 & 5 of this InfoFrame.

The format of the Audio InfoFrame is shown in Table 16.

InfoFrame Type Code	InfoFrame Type = 04 <sub>16</sub> (new)							
InfoFrame Version Number	Version = 01 <sub>16</sub>							
Length of Audio InfoFrame	Length of Audio InfoFrame (10)							
Data Byte 1	CT3	CT2	CT1	CT0	Rsvd	CC2	CC1	CC0
Data Byte 2	Reserved (shall be 0)			SF2	SF1	SF0	SS1	SS0
Data Byte 3	Reserved (shall be 0)							
Data Byte 4	CA7	CA6	CA5	CA4	CA3	CA2	CA1	CA0
Data Byte 5	DM_I NH	LSV3	LSV2	LSV1	LSV0	Reserved (shall be 0)		
Data Byte 6	Reserved (shall be 0)							
Data Byte 7	Reserved (shall be 0)							
Data Byte 8	Reserved (shall be 0)							
Data Byte 9	Reserved (shall be 0)							
Data Byte 10	Reserved (shall be 0)							

Table 16 Audio InfoFrame Format

6.6.1 Audio Identification Information

The information in Data Bytes 1-3 is useful in identifying the audio more quickly. If the DTV and the source device support more than "basic audio," as defined by the physical/link specification, then this information shall be sent and shall accurately identify the stream while digital audio is being sent. If the source device only supports basic audio, it is not required to send this information, but it is recommended. In most cases, it is possible to identify the audio by parsing the actual audio stream (e.g., as specified in IEC61937 [23]). In cases where the audio information in the Audio InfoFrame does not agree with the actual audio stream being received, the conflicting information in the Audio InfoFrame shall be ignored.

Data Byte 3 is reserved and shall be zero.

CT3	CT2	CT1	CT0	Audio Coding Type	CC2	CC1	CC0	Audio Channel Count
0	0	0	0	Refer to Stream Header	0	0	0	Refer to Stream Header
0	0	0	1	IEC60958 PCM [24, 25]	0	0	1	2ch
0	0	1	0	AC-3	0	1	0	3ch
0	0	1	1	MPEG1 (Layers 1 & 2)	0	1	1	4ch
0	1	0	0	MP3 (MPEG1 Layer 3)	1	0	0	5ch
0	1	0	1	MPEG2 (multichannel)	1	0	1	6ch
0	1	1	0	AAC	1	1	0	7ch
0	1	1	1	DTS	1	1	1	8ch
1	0	0	0	ATRAC				
1	0	0	1	One Bit Audio				
1	0	1	0	Dolby Digital +				
1	0	1	1	DTS-HD				
1	1	0	0	MLP				
0Dh-0Fh				Reserved				

Table 17 Audio InfoFrame Data Byte 1

SF2	SF1	SF0	Sampling Frequency	SS1	SS0	Sample Size
0	0	0	Refer to Stream Header	0	0	Refer to Stream header
0	0	1	32 kHz	0	1	16 bit
0	1	0	44.1 kHz (CD)	1	0	20 bit
0	1	1	48 kHz	1	1	24 bit
1	0	0	88.2 kHz			
1	0	1	96 kHz			
1	1	0	176.4 kHz			
1	1	1	192 kHz			

Table 18 Audio InfoFrame Data Byte 2

### 6.6.2 Speaker Mapping and Down-mix Information

Data Bytes 4 and 5 apply only to multi-channel (i.e., more than two channels) uncompressed audio.

CEA-861-C contains the possibility to transmit Multi-Channel Linear Pulse Code Modulation (LPCM) Audio by using up to four IEC60958 compliant transport streams. This is because the Audio InfoFrame and the CEA Extension are capable of supporting up to eight channels of LPCM. However, additional information is required to support carriage of Multi-Channel LPCM streams. This information is provided by the speaker channel allocation information in Data Byte 4.

Data Byte 4 contains information that describes how various speaker locations are allocated to transmission channels. Data Byte 5 contains information that tells the DTV Monitor how much the source device attenuated the audio during a down-mixing operation. The down-mix inhibit flag (DM\_INH) describes whether audio output is permitted to be down-mixed or not. This flag is used in DVD Audio applications.

The labels and placements of speakers used in this standard are defined in Figure 38 and Table 19.

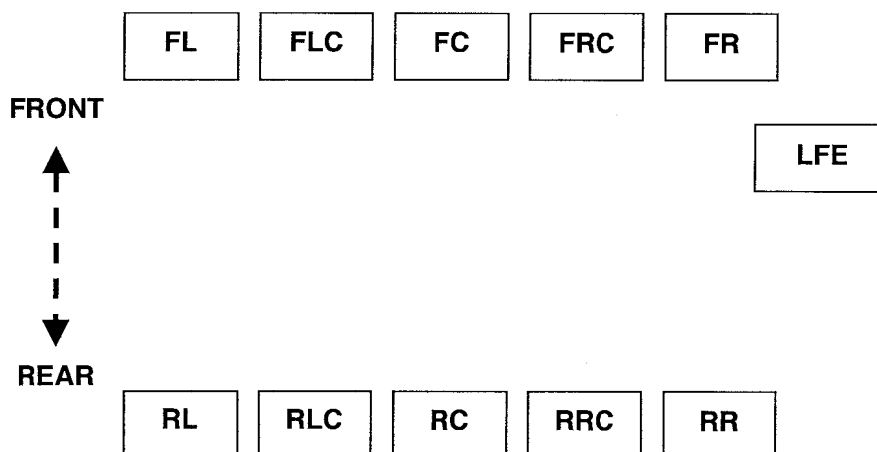

Figure 38 Speaker Placement

<b>Label</b>	<b>Placement</b>
FL	Front Left
FC	Front Center
FR	Front Right
FLC	Front Left Center
FRC	Front Right Center
RL	Rear Left
RC	Rear Center
RR	Rear Right
RLC	Rear Left Center
RRC	Rear Right Center
LFE	Low Frequency Effect

**Table 19 Speaker Placement**

Data Byte 4 contains information that describes how various speaker locations are allocated to transmission channels. The channel allocation is shown in Table 20.

CA (binary)								CA (hex)	Channel Number							
7	6	5	4	3	2	1	0		8	7	6	5	4	3	2	1
0	0	0	0	0	0	0	0	00	-	-	-	-	-	-	FR	FL
0	0	0	0	0	0	0	1	01	-	-	-	-	-	LFE	FR	FL
0	0	0	0	0	0	1	0	02	-	-	-	-	FC	-	FR	FL
0	0	0	0	0	0	1	1	03	-	-	-	-	FC	LFE	FR	FL
0	0	0	0	0	1	0	0	04	-	-	-	RC	-	-	FR	FL
0	0	0	0	0	1	0	1	05	-	-	-	RC	-	LFE	FR	FL
0	0	0	0	0	1	1	0	06	-	-	-	RC	FC	-	FR	FL
0	0	0	0	0	1	1	1	07	-	-	-	RC	FC	LFE	FR	FL
0	0	0	0	1	0	0	0	08	-	-	RR	RL	-	-	FR	FL
0	0	0	0	1	0	0	1	09	-	-	RR	RL	-	LFE	FR	FL
0	0	0	0	1	0	1	0	0A	-	-	RR	RL	FC	-	FR	FL
0	0	0	0	1	0	1	1	0B	-	-	RR	RL	FC	LFE	FR	FL
0	0	0	0	1	1	0	0	0C	-	RC	RR	RL	-	-	FR	FL
0	0	0	0	1	1	0	1	0D	-	RC	RR	RL	-	LFE	FR	FL
0	0	0	0	1	1	1	0	0E	-	RC	RR	RL	FC	-	FR	FL
0	0	0	0	1	1	1	1	0F	-	RC	RR	RL	FC	LFE	FR	FL
0	0	0	1	0	0	0	0	10	RRC	RLC	RR	RL	-	-	FR	FL
0	0	0	1	0	0	0	1	11	RRC	RLC	RR	RL	-	LFE	FR	FL
0	0	0	1	0	0	1	0	12	RRC	RLC	RR	RL	FC	-	FR	FL
0	0	0	1	0	0	1	1	13	RRC	RLC	RR	RL	FC	LFE	FR	FL
0	0	0	1	0	1	0	0	14	FRC	FLC	-	-	-	-	FR	FL
0	0	0	1	0	1	0	1	15	FRC	FLC	-	-	-	LFE	FR	FL
0	0	0	1	0	1	1	0	16	FRC	FLC	-	-	FC	-	FR	FL
0	0	0	1	0	1	1	1	17	FRC	FLC	-	-	FC	LFE	FR	FL
0	0	0	1	1	0	0	0	18	FRC	FLC	-	RC	-	-	FR	FL
0	0	0	1	1	0	0	1	19	FRC	FLC	-	RC	-	LFE	FR	FL
0	0	0	1	1	0	1	0	1A	FRC	FLC	-	RC	FC	-	FR	FL
0	0	0	1	1	0	1	1	1B	FRC	FLC	-	RC	FC	LFE	FR	FL
0	0	0	1	1	1	0	0	1C	FRC	FLC	RR	RL	-	-	FR	FL
0	0	0	1	1	1	0	1	1D	FRC	FLC	RR	RL	-	LFE	FR	FL
0	0	0	1	1	1	1	0	1E	FRC	FLC	RR	RL	FC	-	FR	FL
0	0	0	1	1	1	1	1	1F	FRC	FLC	RR	RL	FC	LFE	FR	FL
0	0	1	0	0	0	0	0	20	Reserved							
...																
1	1	1	1	1	1	1	1	FF								

Table 20 Audio InfoFrame Data Byte 4

The sink device's speaker allocation is not always the same as that contained within the source audio. In this case, the source device should down mix the audio in order to properly meet the sink device's speaker configuration. In actual implementations, all down-mix coefficients are equally attenuated to prevent calculation overflows. The total sound level becomes lower after down-mixing. For this reason, the Level Shift Value should also be transmitted to the sink device to insure the proper sound level is achieved.

Data Byte 5 contains Level Shift Information and a Down-mix Inhibit Flag.

The values of attenuation associated with the Level Shift Values (LSV0-LSV3) are shown in Table 21.

LSV3	LSV2	LSV1	LSV0	Level Shift Value
0	0	0	0	0dB
0	0	0	1	1dB
0	0	1	0	2dB
0	0	1	1	3dB
0	1	0	0	4dB
0	1	0	1	5dB
0	1	1	0	6dB
0	1	1	1	7dB
1	0	0	0	8dB
1	0	0	1	9dB
1	0	1	0	10dB
1	0	1	1	11dB
1	1	0	0	12dB
1	1	0	1	13dB
1	1	1	0	14dB
1	1	1	1	15dB

Table 21 Audio InfoFrame Data Byte 5, Level Shift Value

The Down-mix Inhibit Flag is shown in Table 22.

DM_INH	Describes whether the down mixed stereo output is permitted or not.
0	Permitted or no information about any assertion of this
1	Prohibited

Table 22 Audio InfoFrame Data Byte 5, Down-mix Inhibit Flag

### 6.7 MPEG Source InfoFrame

The MPEG Source InfoFrame describes aspects of the compressed video stream that were used to produce the uncompressed video. In many cases, the compressed source will be MPEG2, although this InfoFrame can be applied to any similar compressed format. Some DTV Monitors will be able to use this information to improve the displayed picture.

NOTE—Problems with the MPEG Source Infoframe have been identified that were not able to be fixed in time for CEA-861-C. Implementation is strongly discouraged until a future revision fixes the problems.

These MPEG Source flags do not match the standard MPEG flags (P, RFF, TFF, etc.) and so do not adequately describe the video. For instance, this data is insufficient to de-interlace 50Hz material. It may also be useful to clarify video fields vs. video frames vs. MPEG frames. There are also questions about frequency and applicability to MPEG 4.

Transmission of this information by the source device is optional. Use of this information by the DTV Monitor is also optional. However, if the DTV Monitor has included Version 3 (or higher) of the CEA Extension in its EDID data structure, it shall be able to receive Version 1 of this InfoFrame.

If the source device supports the transmission of the MS InfoFrame and if it determines that the DTV Monitor is capable of receiving the MS InfoFrame (i.e., the DTV Monitor has included CEA Extension Version 3 in EDID), then this information should be sent once per video frame when applicable. The data applies to the next full frame of video data.

The format of the MPEG Source InfoFrame is shown in Table 23.

InfoFrame Type Code	InfoFrame Type = 05 <sub>16</sub> (new)							
InfoFrame Version Number	Version = 01 <sub>16</sub>							
Length of MPEG Source InfoFrame	Length of MPEG Source InfoFrame (10)							
Data Byte 1	<b>MB#0</b> (MPEG Bit Rate: Hz Lower → Upper)							
Data Byte 2	<b>MB#1</b>							
Data Byte 3	<b>MB#2</b>							
Data Byte 4	<b>MB#3</b> (Upper Byte)							
Data Byte 5	Rsvd	Rsvd	Rsvd	<b>FR0</b>	Rsvd	Rsvd	<b>MF1</b>	<b>MF0</b>
Data Byte 6	Reserved (shall be 0)							
Data Byte 7	Reserved (shall be 0)							
Data Byte 8	Reserved (shall be 0)							
Data Byte 9	Reserved (shall be 0)							
Data Byte 10	Reserved (shall be 0)							

**Table 23 MPEG Source InfoFrame format**

Data Bytes 1-4 give the MPEG bit rate. The MPEG Bit Rate is stored as a 32-bit number and is expressed in Hertz. MB#0 contains the least significant byte while MB#3 contains the most significant byte. If the MPEG Bit Rate is unknown or this field doesn't apply, then all of the bits in Data Bytes 1-4 shall be set to 0.

**Example:**

10 Mbps → 10,000,000 Hz (dec.) → 0x 00 98 96 80 (hex.) Upper ,, Lower Byte

**Byte 1 MB#0** 0x80 Lower Byte

**Byte 2 MB#1** 0x96

**Byte 3 MB#2** 0x98

**Byte 4 MB#3** 0x00 Upper

MF1 and MF0 in Data Byte 5 (see Table 24) designate whether the current field/frame was generated from an I, B, or P picture from the source MPEG stream. If this is unknown or doesn't apply, then the field shall be set to "unknown."

In some cases, the source device will create 60 field/second video from 24 frames/second source material. 3:2 pulldown is commonly used. FR0 can be used to designate whether a field is a repeated field or not. The DTV Monitor can use this information to improve the picture. If 3:2 pulldown does not apply to the current video decoding, then all of the fields/frames should be marked as "New field."

FR0	Field Repeat (for 3:2 pull-down)	MF1	MF0	MPEG Frame
0	New field (picture)	0	0	Unknown (No Data)
1	Repeated Field	0	1	I Picture
		1	0	B Picture
		1	1	P Picture

Table 24 MPEG Source InfoFrame Data Byte 5

### 7 EDID Data Structure

Extended Display Identification Data (EDID) was created by VESA to enable plug and play capabilities of monitors. This data, which is stored in the sink device, describes video formats that the DTV Monitor is capable of receiving and rendering. The information is supplied to the source device, over the interface, upon the request of the source device. The source device then chooses its output format, taking into account the format of the original video stream and the formats supported by the DTV Monitor. The source device (e.g., STB) is responsible for the format conversions necessary to supply video in an understandable form to the DTV Monitor.

The EDID content shall comply with EDID data structure version 1, revision 3 [8] or newer. This is known as Enhanced EDID (i.e., E-EDID). The DTV Monitor shall support E-DDC [9] as the method of transporting EDID information. A source device shall be capable of using Enhanced DDC to read the entire EDID since critical information may not otherwise be readable if the monitor contains a large EDID.<sup>12</sup> The EDID 1.3 block's version number will be changing in upcoming VESA revisions as will the version number of the CEA Extension. Because the data structure of these blocks will remain backwards compatible, the source shall ignore these version numbers during the parsing of the EDID.

The DTV Monitor shall protect its EDID from accidental corruption resulting from I2C errors by write-protecting its contents.

See Annex A and Annex D for an example EDID.

#### 7.1 Use of CEA Extensions

Two of the four 18-byte descriptor slots contained in EDID Block 0 are designated for a Monitor Range Limits Descriptor and a Monitor Name Descriptor.<sup>13</sup> Users of CEA-861-C should note that alternate usage of these descriptors is possible and, therefore, dependency upon data in these descriptors should be avoided. Consequently, the E-EDID standard provides a method for including only two Detailed Timing Descriptors. To accommodate additional Detailed Timing Descriptors, the CEA Extension has been defined. The tag (02<sub>16</sub>) for this extension was previously reserved within VESA, but has now been assigned to CEA for the purposes of CEA-861-C. Therefore, further changes to this structure are under the control of CEA. It is referred to in this standard as the CEA Extension.

Three versions of the CEA Extension exist. If more than one CEA Extension is included in EDID, they shall all be the same version.

To maintain backward compatibility, newer versions of the CEA Extension include all of the fields that were present in the previous versions. Additionally, length fields are provided to let the source device know how big a block is so that it can skip over it if it doesn't understand it. Future versions of the CEA Extension are expected to have the version number incremented and be backward compatible with

<sup>12</sup> VESA has recently published a display information extension (DI-EXT) for EDID [34]. To be able to accommodate this extension and other extensions (such as the extension containing additional detailed timing descriptors), a DTV Monitor may need to use E-DDC to be able to include more than one extension. It is recommended that the source device be able to read any extension that may be included per the guidelines contained in Enhanced EDID [8].

<sup>13</sup> The E-EDID Standard defines a tag (02<sub>16</sub>) that allows for a block to be added with additional timing formats. VESA has assigned the Tag for this timing extension to CEA for the purposes of CEA-861-C. The information in this section is now the controlling information on this extension and is considered normative.



previous versions. A current generation source is able to parse these future EDIDs exactly as it does existing EDIDs, if it ignores version number. Sources shall ignore the version number during the parsing of the EDID structure.

CEA Extension Version 1 was created for 861 and only provides a way to supply extra Detailed Timing Descriptors. It is still permitted to be used for some DTV Monitors (e.g. limited format DVI displays) but Version 3 is more applicable for most devices.

CEA Extension Version 2 is no longer supported and shall not be included in DTV Monitors.

Version 3 includes all of the fields and capabilities of Versions 1 & 2, but also includes the ability to specify any of the CEA video formats using "CEA Short Video Descriptors." It provides the ability for the DTV Monitor to specify what types of advanced audio it supports using "CEA Short Audio Descriptors." It also provides a way for the sink device to specify its speaker configuration. This information is complementary to the speaker channel allocation information that is sent in the Audio InfoFrame.

If a DTV Monitor supports any video format with a format code greater than 7,  $YCbCr$  color space, InfoFrames, or digital audio (e.g., is an HDMI monitor), then it shall include the version 3 (or higher) CEA Extension in its EDID data structure. If the DTV Monitor supports any type of digital audio on this interface, then it shall also support Basic Audio (see Section 2.2) and shall indicate this by setting the Basic Audio bit in the CEA Extension. If the DTV Monitor supports multi-channel (i.e., more than two channels) uncompressed audio, then it shall include the Speaker Allocation Data Block in the CEA Extension. It is recommended that the DTV Monitor include a valid Speaker Allocation Data Block if it supports any type of digital audio on the interface, but this is not required. The ability to interpret the audio identification information in the Audio InfoFrame is indicated by the DTV Monitor's support of advanced audio (audio other than "basic audio"). The DTV Monitor's ability to act upon the speaker allocation information contained in the Audio InfoFrame is indicated by its support of multi-channel (i.e., more than two channels) uncompressed audio in EDID.

## 7.2 Describing Video Formats in EDID

Two methods of describing video formats are used in CEA-861-C (Detailed Timing Descriptors and CEA Short Video Descriptors).

The DTV Monitor shall declare support for all of the DTV formats that it supports in EDID block 0 or in the CEA Extension(s). The 640x480 flag, in the Established Timings area, shall always be set, since the 640x480 format is a mandatory default timing, timing extensions shall be included to provide timing descriptors for all supported formats.

When using CEA Extension Version 1, all of the CEA video formats listed in E-EDID are described using Detailed Timing Descriptors. No matter which CEA Extension is used, there is also room for two Detailed Timing Descriptors in EDID Block 0. CEA Extension Version 3 can include a combination of Detailed Timing Descriptors and Short Video Descriptors.

If a Version 3 CEA Extension has been included in EDID, all CEA video formats shall be advertised using Short Video Descriptors, even if they are also advertised using the Detailed Timing Descriptors (see 7.2.1).

Even though Short Video Descriptors are now available in the Version 3 CEA Extension, there is still a need to use Detailed Timing Descriptors if full backward compatibility with legacy sources is desired. Format with video ID codes of 2 to 5 and 17 to 20 should be advertised using the Detailed Timing Descriptors for any video formats that the DTV designer wishes to guarantee are available to sources that do not understand the Short Video Descriptors and that require Detailed Timing Descriptors for proper operation. If sufficient room is not available in the first two blocks of the EDID for all of the supported video formats, the DTV designer may choose to declare support for some of the less important formats in Short Video Descriptors only.

### 7.2.1 Use of EDID Detailed Timing Descriptors

For the purposes of this standard, a DTV Monitor intended for 60 Hz countries shall support both the 60 Hz and 59.94 Hz version of any format it supports. The 60 Hz version shall be described in the EDID structure for HDTV formats, the 59.94Hz version shall be described for all 480-line formats.

The "preferred" timing format shall be described in the first Detailed Timing Descriptor and shall include the primary aspect ratio of the video format timing.

Note that the EDID Detailed Timing Descriptor allows for the designation of an interlaced format. However, there are no provisions to specify separate vertical blanking/sync for Field 1 and Field 2. Therefore, for the purposes of this standard, the following rules apply for interlaced formats:

- a) The Field 1 Vertical Blanking Interval shall equal the Vertical Blanking Lines in the Detailed Timing Descriptor.
- b) The Field 2 Vertical Blanking Interval shall equal the Vertical Blanking Lines in the Detailed Timing Descriptor + 1.
- c) The Field 1 Vertical Sync Offset shall equal the Vertical Sync Offset in the Detailed Timing Descriptor.
- d) The Field 2 Vertical Sync Offset shall equal the Vertical Sync Offset in the Detailed Timing Descriptor + 1/2.

Different Detailed Timing Descriptors are required for video formats with different picture aspect ratios. The vertical and horizontal image size parameters shall contain numbers that describe the aspect ratio of the displayed video (actual dimensions are preferred, but not required). It is anticipated that there will be two cases: either 4:3 or 16:9.

Examples of Detailed Timing Descriptors for the video formats are contained in Annex A.

### 7.2.2 Order of Dual-Aspect Ratio Detailed Timing Descriptors

Source devices that do not support the AVI InfoFrame (e.g., DVI sources) shall consider the first EDID descriptor of any dual-aspect ratio timing to be the display-assumed aspect ratio for that timing. DTV Monitors that support any dual-aspect ratio timing shall list the preferred aspect ratio before the other and shall assume that any signal matching that timing should be displayed at the preferred aspect ratio unless receiving an alternate indication in an AVI InfoFrame.

Source devices must also handle transmission of a dual-aspect ratio timing to a DTV Monitor that does not support the reception of aspect ratio information (e.g., a DVI monitor). In that case, the DTV Monitor only supports one of these two formats. The supported format would be advertised in the EDID data structure.

### 7.2.3 Source Device Guidance

If the DTV Monitor has provided a timing descriptor for a particular video format decoded in the source, it is recommended that the source send video across the interface without performing format conversion. If a conversion must be done, it is recommended that the conversion be to a format identified by the display as a 'native format' as explained in Section 7.4 and Section 7.5. Examples of different conversion processes are illustrated in Annex F.

If EDID can't be read correctly by the source device (perhaps cable is too long), then the source device may use 640X480p (default) since this format is required to be supported by the sink device in CEA-861-C and the general physical link interface standards that can be used with CEA-861-C (see Section 3.1). If the source device can determine that the sink device is CEA-861-C-compliant, then it may supply 720X480p since support for this format timing is required in all CEA-861-C-compliant sink devices. If the source device can determine the preferred picture aspect ratio for the 720X480p format, then it should use that picture aspect ratio.

## 7.3 CEA Extension Version 1

The first version was created for CEA-861 and only provides a way to supply extra EDID Detailed Timing Descriptors.

The CEA Extension in Table 25 follows the format described in Section 2.2.1.3 of [8]. The EDID Extension Tag for this extension shall be 02h. VESA has given control of the definition of this extension to CEA for the purposes of this standard. The first format listed in the base EDID data structure is the preferred format.

Byte #	Value	Description	Format
0	02h	Tag (02h)	
1	01h	Revision Number	
2		Byte number offset $d$ where 18-byte descriptors begin (typically Detailed Timing Descriptors)	$d$ = offset for the byte following the reserved data block. If no data is provided in the reserved data block, then $d=4$ . If no detailed timing descriptions are provided then $d=0$ .
3		Reserved	Set to 00h
4		Start reserved data block	This section was previously reserved for 8 byte timing descriptors but is currently a reserved data block.
$d-1$		End of reserved data block.	
$d$		Start of 18-byte descriptors	See Section 3.10.2 of [8]
$d+(18Xn)-1$		End of 18-byte descriptors where $n$ is the number of descriptors included	
$d+(18Xn)$	00h	Beginning of Padding	
126	00h	End of Padding	
127		Checksum	xxh = This byte should be programmed such that a one-byte checksum (add all bytes together) of the entire 128 byte block equals "00h".

Table 25 CEA Extension Version 1

#### 7.4 CEA Extension Version 2

CEA Extension Version 2 is deprecated and shall not be included in DTV monitors. See Table 26.

Byte #	Value	Description	Format
0	02h	Tag (02h)	
1	02h	Revision Number	
2		Byte number offset <i>d</i> where 18-byte descriptors begin (typically Detailed Timing Descriptors)	<i>d</i> = offset for the byte following the reserved data block. If no data is provided in the reserved data block, then <i>d</i> =4. If <i>d</i> =0, then no detailed timing descriptors are provided and no data is provided in the reserved data block.
3		Total number of native (preferred) formats described by Detailed Timing Descriptors in entire E-EDID structure. Also, indication of underscan support, audio support, and support of YC <sub>B</sub> C <sub>R</sub> is included	bit 7 (underscan) = 1 if DTV Monitor supports underscan. bit 6 (audio) = 1 if DTV Monitor supports basic audio bit 5 (YC <sub>B</sub> C <sub>R</sub> 4:4:4) = 1 if DTV Monitor supports YC <sub>B</sub> C <sub>R</sub> 4:4:4 in addition to RGB bit 4 (YC <sub>B</sub> C <sub>R</sub> 4:2:2) = 1 if DTV Monitor supports YC <sub>B</sub> C <sub>R</sub> 4:2:2 in addition to RGB lower 4 bits = total number of native formats.
4		Start reserved data block	This section was previously reserved for 8 byte timing descriptors <sup>14</sup> but is currently a reserved data block.
<i>d</i> -1		End of reserved data block.	
<i>d</i>		Start of 18-byte descriptors	See Section 3.10.2 of [8]
<i>d</i> +(18 <i>Xn</i> )-1		End of 18-byte descriptors where <i>n</i> is the number of descriptors included	
<i>d</i> +(18 <i>Xn</i> )	00h	Beginning of Padding	
126	00h	End of Padding	
127		Checksum	xxh = This byte should be programmed such that a one-byte checksum (add all bytes together) of the entire 128 byte block equals "00h".

Table 26 CEA Extension Version 2

### 7.5 CEA Extension Version 3

Version 3 includes all of the capabilities of Versions 1 & 2, but also includes the ability to specify any of the CEA formats using "CEA Short Video Descriptors." It provides the ability for the DTV Monitor to specify what types of advanced audio it supports using "CEA Short Audio Descriptors." It also provides a way for the sink device to specify its speaker configuration. This information is complementary to the speaker channel allocation information that is sent in the Audio InfoFrame.

Byte 3 contains a field for designating the number of native formats supported by the DTV Monitor. The first format listed in the base EDID data structure is the preferred format. Other native formats should be listed consecutively after that format. The new field consists of the count of the number of timing descriptors, starting with any listed in the base 128 EDID data structure and continuing with those listed in

<sup>14</sup> The 8-byte descriptors do not support the DTV formats defined in this standard since they are not compliant with VESA GTF [36].

the extension blocks, that are to be considered "native" timings (see Section 7.2.3). If more than one timing extension is needed, then the value shall be the same in all extensions. Value zero means that this information is not provided (for backward compatibility with prior implementations).

In order to ensure  $YC_B C_R$  interoperability between any two  $YC_B C_R$ -capable devices, a DTV monitor that supports either type of  $YC_B C_R$  pixel data (4:2:2 or 4:4:4) should support both types and therefore would set both bits 4 and 5 of byte 3.

NOTE—The HDMI specification requires this behavior.

A DTV monitor that does not support  $YC_B C_R$  pixel data shall have both bits 4 and 5 clear.

Additionally, the Version 3 CEA Extension can include Short Video Descriptors (SVDs) for advertising the video formats defined in CEA-861-C, and it can include Short Audio Descriptors for describing support of advanced audio formats (compressed and uncompressed). These descriptors are contained in data blocks identified by "Tags." Support of "basic audio" shall still be advertised using the basic audio bit. The DTV Monitor is required to support Basic Audio if it supports digital audio on this interface. The details of "basic audio" are defined in Section 2.2).

Version 3 of the CEA Extension can also include a Speaker Allocation Data Block (SADB). This data block contains information on the sink device's speaker configuration. This information is required if the sink device supports multi-channel digital audio as indicated using CEA Short Audio Descriptors.

Version 3 of the CEA Extension can also include a Vendor Specific Data Block (VSDB). This data block can be used to include information not specifically defined in this standard. The format of this descriptor is determined by the owner of the Registration ID used at that beginning of the block. Any number of these data blocks (barring other restrictions) may be present in the CEA Extension Version 3.

CEA Extension Version 3 is shown in Table 27.

Byte #	Value	Description	Format
0	02h	Tag (02h)	
1	03h	Revision Number	
2		Byte number offset <i>d</i> where 18-byte descriptors begin (typically Detailed Timing Descriptors)	<i>d</i> = offset for the byte following the reserved data block. If no data is provided in the reserved data block, then <i>d</i> =4. If <i>d</i> =0, then no detailed timing descriptors are provided and no data is provided in the reserved data block.
3		Total number of native formats described by Detailed Timing Descriptors in entire E-EDID structure. Also, indication of underscan support, audio support, and support of YC <sub>B</sub> C <sub>R</sub> is included	<b>bit 7</b> (underscan) = 1 if sink device supports underscan. <b>bit 6</b> (audio) = 1 if sink device supports basic audio <b>bit 5</b> (YC <sub>B</sub> C <sub>R</sub> 4:4:4) = 1 if sink device supports YC <sub>B</sub> C <sub>R</sub> 4:4:4 in addition to RGB <b>bit 4</b> (YC <sub>B</sub> C <sub>R</sub> 4:2:2) = 1 if sink device supports YC <sub>B</sub> C <sub>R</sub> 4:2:2 in addition to RGB <b>lower 4 bits</b> = total number of native formats described using Detailed Timing Descriptors.
4		Start of data block collection	This section was previously reserved for 8 byte timing descriptors <sup>15</sup> but is currently used for CEA Data Block Collection (see Table 28).
<i>d</i> -1		End of data block collection.	
<i>d</i>		Start of 18-byte detailed timing descriptors	
<i>d</i> +(18 <i>Xn</i> )-1		End of 18-byte detailed timing descriptors where <i>n</i> is the number of descriptors included	See Section 3.10.2 of [8]
<i>d</i> +(18 <i>Xn</i> )	00h	Beginning of Padding	
126	00h	End of Padding	
127		Checksum	xxh = This byte should be programmed such that a one-byte checksum (add all bytes together) of the entire 128 byte block equals "00h".

Table 27 CEA Extension Version 3

Audio and Video Data Blocks shall contain Short Descriptors to indicate the support of optional capabilities not listed in other sections of EDID. Examples of the optional capabilities are support of various audio and video formats included in this standard (see Table 17).

Video formats should be listed as Detailed Timing Descriptors per the recommendations presented in Section 7.2.2. Additionally, all supported formats that are defined in CEA-861-C shall be listed using short video descriptors if the Version 3 CEA Extension is included in the DTV Monitor's EDID data structure.

The format of the "CEA Data Block Collection" shall conform to that shown in Table 28. The order of the Data Blocks is not constrained. It is also possible to have more than one of a specific type of data block if necessary to include all of the descriptors needed to describe the DTV Monitor's capabilities. The header

<sup>15</sup> The 8-byte descriptors do not support the DTV formats defined in this standard since they are not compliant with VESA GTF [36].

of a Data Block consists of one byte, with 3 bits used for the tag code to label the type of data and 5 bits used to indicate the length of the block (Table 29). The list of tag codes is shown in Table 30.

	Byte#	Bits 5-7	Bits 0-4
Video Data Block	1	Video Tag Code	length=total number of video bytes following this byte ( $L_1$ )
	2	CEA Short Video Descriptor 1	
	3	CEA Short Video Descriptor 2	
	...	...	
	$1+L_1$	CEA Short Video Descriptor $L_1$	
Audio Data Block	$2+L_1$	Audio Tag Code	length=total number of audio bytes following this byte ( $L_2$ )
	$3+L_1$	CEA Short Audio Descriptor 1	
	$4+L_1$		
	$5+L_1$		
	...	...	
	...	...	
	$L_1+L_2$	CEA Short Audio Descriptor $L_2/3$	
$1+L_1+L_2$			
$2+L_1+L_2$			
Speaker Allocation Data Block	$3+L_1+L_2$	Speaker Allocation Tag Code	length=total number of speaker allocation bytes following this byte ( $L_3=3$ )
	$4+L_1+L_2$	Speaker Allocation Data Block Payload (3 bytes)	
	$5+L_1+L_2$		
	$6+L_1+L_2$		
Vendor Specific Data Block	$7+L_1+L_2$	Vendor Specific Tag Code	length=total number of vendor specific bytes following this byte ( $L_4$ )
	$8+L_1+L_2$	24-bit IEEE Registration Identifier (least significant byte first)	
	$9+L_1+L_2$		
	$10+L_1+L_2$		
	....	Vendor Specific Data Block Payload ( $L_4-3$ bytes)	
.....	.....		

**Table 28 General Format of "CEA Data Block Collection"**

The General Tag format is shown in Table 29. The first three bits are a Tag Code. This tag code designates the format of the bytes that follow. The last five bits are a length field that designates the number of bytes in the data block associated with the tag. The number of bytes does not include the tag. In the case of a video data block or an audio data block, the data block consists of a number of short descriptors. For other data blocks, the format may be different (e.g., Speaker Allocation Data Block). However, the length is always the number of bytes following the tag.

Byte#	bits							
	7	6	5	4	3	2	1	0
1	Tag Code			Length of following data block payload (in bytes)				

**Table 29 General Tag Format**

Codes	Type of Data Block
0	Reserved
1	Audio Data Block (includes one or more Short Audio Descriptors)
2	Video Data Block (includes one or more Short Video Descriptors)
3	Vendor Specific Data Block
4	Speaker Allocation Data Block
5	VESA DTC Data Block
6	Reserved
7	Use Extended Tag

**Table 30 CEA Data Block Tag Codes**

If the Tag Code is 7 (Use Extended Tag) then the second byte of the data block contains the Extended Tag Code, which indicates the actual type of the data block. For backwards compatibility, the Length field in the first byte does include the second byte, which contains the Extended Tag Code. Note that data blocks with Tag Codes of 1 through 6 are limited to containing 31 useful bytes whereas those with Extended Tag Codes are limited to 30 useful bytes.

Byte#	bits							
	7	6	5	4	3	2	1	0
2	Extended Tag Code							

**Table 31 Extended Tag Format (2<sup>nd</sup> Byte of Data Block)**

Extended Tag Codes	Type of Data Block
0	CEA Miscellaneous Video Fields
1	Vendor-Specific Video Data Block
2	Reserved for VESA Video Display Device Information Data Block
3	Reserved for VESA Video Data Block
4...15	Reserved for video-related blocks
16	CEA Miscellaneous Audio Fields
17	Vendor-Specific Audio Data Block
18...31	Reserved for audio-related blocks
32...255	Reserved for general

**Table 32 CEA Data Block Tag Codes**

Any data block with an Extended Tag in the 0 to 15 range indicates strictly video-related characteristics of the display. Any repeater device that re-transmits a video stream from a source to a DTV monitor without any modification of the video timing or video data or video-related InfoFrame(s) shall also pass every such data block upstream, that is, the repeater shall copy the contents of the data block(s) from the downstream DTV Monitor's EDID to the repeater's own upstream EDID.

Any data block with an Extended Tag in the 16 to 31 range indicates strictly audio-related characteristics of the display. Any repeater device that re-transmits an audio stream from a source to a DTV monitor without any modification of the audio timing or audio data or audio-related InfoFrame(s) shall also pass every such data block upstream, that is, the repeater shall copy the contents of the data block(s) from the downstream DTV Monitor's EDID to the repeater's own upstream EDID.



Repeaters shall not copy the contents of any other data block from a downstream EDID to their own upstream EDID unless the characteristics of the DTV Monitor indicated by that data block are known to be also true for the repeater device or the combination of the repeater and downstream device. This also applies to the original Vendor-Specific Data Block (Data Block Tag = 3); if the repeater does not recognize the vendor ID or does not understand the entire contents of that block, it shall not be copied into the repeater's EDID.

### 7.5.1 Video Data Block

When a Version 3 CEA Extension is provided in the DTV Monitor's EDID data structure, a short video descriptor shall be provided for each CEA video format supported by the DTV Monitor. The format of the short video descriptor shall conform to that shown in Table 33. The lower 7-bits are an index associated with the video format supported. These indexes are the same as those used in the AVI InfoFrame and are shown in Table. The first bit declares if the format is a native format of the display (native =1, not native = 0). The rules regarding how to handle formats marked as native apply (see Section 7.2.3).

Byte#	bits							
	7	6	5	4	3	2	1	0
1	Native	Video Identification Code						

**Table 33 Short Video Descriptor**

### 7.5.2 Audio Data Block

If audio is supported in the DTV Monitor, as indicated by the basic audio support bit in the Version 3 CEA EDID Descriptor, then CEA short audio descriptors shall be used to declare which (if any) audio formats are supported in addition to basic audio. If only basic audio is supported, no Short Audio Descriptors are necessary.

The Short Audio Descriptor shall conform to the formats given in Table 34, Table 35 and Table 36. Several types of audio may be supported, but each one shall be listed in its own short audio descriptor with its designated code and the associated information. The list of audio coding types is given in Table 37.

Each Short Audio Descriptor is 3-bytes long. There can be up to 32 bytes following any tag, therefore there may be up to 10 Short Audio Descriptors in the Audio Data Block.

The format of the third byte is determined by the audio format code contained in the first byte as shown in Table 34, Table 35 and Table 36. One is used for uncompressed audio (i.e., Linear PCM), the other is used for compressed audio (i.e., AC-3, MPEG1, MP3, MPEG2, AAC, DTS, and ATRAC). The CEA Short Audio Descriptor is detailed in Table 34, Table 35, and Table 36.

Byte#	bits							
	7	6	5	4	3	2	1	0
1	Rsvd	Audio Format Code = 0001				Max Number of channels - 1		
2	Rsvd	192kHz	176.4kHz	96kHz	88.2kHz	48kHz	44.1kHz	32kHz
			z		z		z	
3	Reserved (shall be 0)					24 bit	20 bit	16 bit

**Table 34 CEA Short Audio Descriptor for Audio Code = 1 (LPCM)**

bits								
Byte#	7	6	5	4	3	2	1	0
1	Rsvd	Audio Format Code				Max Number of channels - 1		
2	Rsvd	192kHz	176.4kH	96kHz	88.2kH	48kHz	44.1kH	32kHz
			z		z		z	
3	Maximum bit rate divided by 8 kHz.							

Table 35 CEA Short Audio Descriptor for Audio Codes 2 to 8

bits								
Byte#	7	6	5	4	3	2	1	0
1	Rsvd	Audio Format Code				Max Number of channels - 1		
2	Rsvd	192kHz	176.4kH	96kHz	88.2kH	48kHz	44.1kH	32kHz
			z		z		z	
3	Reserved (0) [Can be defined by Audio Codec Vendor]							

Table 36 CEA Short Audio Descriptor for Audio Codes 9 to 15

The Audio Format Codes used in each Short Audio Descriptor are shown in Table 37. These values are the same as the values used in the Audio InfoFrame, which are shown in Table 17.

Codes	Audio Format Description
0	Reserved
1	Linear PCM (e.g., IEC60958)
2	AC-3
3	MPEG1 (Layers 1 & 2)
4	MP3 (MPEG1 Layer 3)
5	MPEG2 (multichannel)
6	AAC
7	DTS
8	ATRAC
9	One Bit Audio
10	Dolby Digital +
11	DTS-HD
12	MLP
13..15	Reserved for audio format 13..15

Table 37 Audio Format Codes

Some information on typical audio applications is contained in Annex J (Informative).

If the DTV Monitor supports multi-channel uncompressed digital audio as indicated in the Audio Data Block, then the Speaker Allocation Data Block shall be included in the CEA Extension. It is recommended that the DTV Monitor include a valid Speaker Allocation Data Block if it supports any type of digital audio (including Basic Audio), but this is not required.

### 7.5.3 Speaker Allocation Data Block

The payload of the Speaker Allocation Data Block is shown in Table 38. In the Data Collection Block, this payload is preceded by a Tag Code Byte that includes a tag equal to four and a length of three (see Table 28). The first byte of the Data block payload consists of seven bits and one reserved bit. The DTV Monitor signifies that a speaker, or pair of speakers, is present by setting the bit associated with that speaker or pair of speakers to one. The speaker designations are the same as is used in the Audio InfoFrame (see Figure 38 and Table 19). The Front Left and Front Right channels are not independent and are shown as FL/FR in the table. The Front Left Center and Front Right Center (FLC/FRC) Rear Left and Rear Right (RL/RR), and Rear Left Center and Rear Right Center (RLC/RRC) channels are also not independent.

Byte#	Bits							
	7	6	5	4	3	2	1	0
1	Rsvd	RLC/ RRC	FLC/ FRC	RC	RL/ RR	FC	LFE	FL/ FR
2	Reserved (shall be 0)							
3	Reserved (shall be 0)							

**Table 38 Speaker Allocation Data Block Payload**

#### 7.5.4 Vendor Specific Block

The content of the Vendor Specific Block is defined in Table 28.

A DTV Monitor may contain one or more Vendor-Specific Data Blocks (VSDB) to indicate proprietary information that may be of interest to the vendor's own source devices.

The VSDB shall contain the 3 bytes of the IEEE OUI as well as any additional payload bytes needed.

NOTE—HDMI sinks use one version of the VSDB to indicate HDMI-specific characteristics of the DTV Monitor. Additional VSDBs, such as those with the vendor's own IEEE OUI, may also be included in the E-EDID.

### **Annex A Example EDID and Detailed Timing Descriptors**

Annex A addresses issues related to the VESA Extended Display Identification Data (EDID) tables utilized within CEA-861-C.

Annex A provides examples and guidance to manufacturers that utilize CEA-861-C; however included in this Annex are several normative requirements identified by the "shall" verb. Specifically, this guidance is for the implementation of EDID tables. Primarily, the motivation is to help insure interoperability between various source and sink devices that will be found in the marketplace. Annex A should in no way prohibit consumer device manufacturers from including additional features, and Annex A should not be interpreted as stipulating any form of upper limit to EDID features.

#### **A.1 Background**

CEA-861-C follows requirements in the VESA Enhanced Extended Display Identification Data Standard (E-EDID). EDID tables exist within the sink device and are used to declare its capabilities to source devices. The source device uses these declared capabilities to determine the appropriate signal parameters to send across the interface for consumption by the sink device.

Possibly, there are varied and inconsistent ways to create EDID tables and therefore, a common methodology is desirable to help insure interoperability between various sink and source devices. The purpose of this Recommended Practice is to provide a consistent and understandable guideline for creating EDID tables that reside within consumer electronics products. Consequently, this document does not address implementations that utilize repeaters.

#### **A.2 EDID Tables**

CEA-861-C requires use of the VESA EDID version 1.3 data structure, or newer. Previous versions of EDID are not supported and such use is deprecated. EDID 1.3 requires use of certain features for Computer Displays. Despite these requirements, some features are not applicable to certain display technologies and applications. For example, the Monitor Range Limits descriptor and support of the Generalized Timing Formula apply to CRT based multi-scan systems and not flat panel or most consumer electronics equipment. For consumer electronics devices (CE devices) the application is limited to a simple declaration of the sink device's capabilities and attributes. This section provides an outline describing the various blocks that reside with the EDID structure.

##### **A.2.1 EDID Table Construction**

The table construction is divided into blocks dedicated to specifying various attributes. Each block is 128 bytes in length. Block 0 is mandatory and the following blocks are called "extensions". The extensions are limited to 254 blocks.

It is possible to use the first extension as a data block or as an index (EDID Block Map Extension) that lists more than one extension. When only one extension is required, it is called Block 1 and is used for data. In cases where more than one extension is required, the first extension or Block 1 is used as an index map that lists extension locations. Additional extensions are referred to as Blocks, such as Block 2, Block 3, and so on.

Each extension contains a Block Tag that declares the contents of each extension. Source devices should read Block 0 (at address 7Eh), check for multiple extensions, identify each block or extension and be able to appropriately interpret the data contained therein. Users should be knowledgeable of defined Tags contained within section 2.2.1.4 of the VESA E-EDID standard.

Source devices should read all extensions and Block Tags. CE devices complying with EIA/CEA-861 will use the CEA Extension Version 1 to specify additional video formats as necessary. There are three possible versions of the CEA Extension and source devices should read the contents of the extension even if they cannot recognize the version number. This is to insure that the Detailed Timing Descriptors are read.

For CE devices, the number of extensions or blocks is dependent upon the amount of supported video formats and features. Annex A shows one extension containing four Detailed Timing Descriptors (see Section 4.3).

### A.2.2 Detailed Explanation of EDID Block Zero

For this discussion, block zero and subsequent extension blocks are divided into smaller sections, each receiving an explanation of terminology and use. The contents in each section are a possible example of a typical CE device application.

A data format protocol is required to properly utilize the various blocks. Data within the various blocks is placed in fields with varying bit lengths. These lengths range from one bit to two bytes. The data length convention is defined and shown in Table 39.

Bit range	Convention
1 ~ 7 bits	Binary, consecutive sequence
8 bits (byte)	Binary, according to location
9 ~ 15 bits	Binary, sequence according to field
16 bits (two bytes)	Binary, LSB first
Greater than two bytes: (Character string)	ASCII code, consecutive string order, ex: HDTV = 0x48, 0x44, 0x54, 0x56

Table 39 Standard Data Lengths

### A.2.3 Block Zero Header Section

The header is comprised of eight addresses, 00h through 07h, containing a simple binary data pattern that is used to identify the EDID table. There is one byte per address for a total of eight bytes. Address locations 00h and 07h contain data values 00h and locations 01h through 06h contain FFh as data values. CEA-861-C requires this data. This header is used to determine the beginning of an EDID structure in a sink device. See Table 40.

Address Hex	Example Data Hex Dec		Format	Remarks
00	00	0	Binary	These fixed values are <b>REQUIRED</b> to properly identify start of EDID table data
01	FF	255		
02	FF	255		
03	FF	255		
04	FF	255		
05	FF	255		
06	FF	255		
07	00	0		

Table 40 Block Zero Header

Although future versions of EDID may not contain an 8-byte header at the beginning of Block 0, compliant devices are expected to use this header. However, presence of the header is not an indication that the following EDID data is valid. A checksum byte is provided for the purpose of verifying that a device's EDID structure has been correctly read. See Section 4.2.9 for more detail.

### A.2.4 Vendor / Product Identification

This section's example starts and ends with address locations 08h and 11h. Byte allocation for each location is as follows:

08h ~ 09h are a two byte EISA ID for Manufacturer Name and should contain a valid identification number. Data for these bytes is based upon compressed ASCII, for example: "CEA" is created by using five-bit codes, where "C" = 00011. "E" = 00101, and "A" = 00001. Table 41 illustrates the address location and sample data for Manufacturer's Name, which is "CEA".

For information on how to obtain an EISA ID, contact:

Microsoft

URL: <http://www.microsoft.com/whdc/system/pnppwr/pnp/pnpid.mspx>

E-mail: [pnpid@microsoft.com](mailto:pnpid@microsoft.com)

CEA-861-C

0Ah ~ 0Bh are two bytes available for Product code; the manufacturer determines this code.

0Ch ~ 0Fh are four bytes to be used for product Serial Number, which is defined as a 32-bit serial number. There is no specific requirement defined for the data or format of the serial number. This field should be zero if the serial number is contained in an ASCII serial number descriptor (see Section 4.3.6). CEA-861-C implementations should use 00h as padding for the Block 0 serial number if no serial number is provided in Block 0.

For the source box, if an ASCII Serial Number Descriptor is included in the sink device, then the source box should ignore the field in Block 0. If no ASCII Serial Number Descriptor is present, then the field may have meaning. Ignore this block if all bytes are 00h.

10h is one byte for Week of Manufacture. The designated values for this field range from 1 to 53. Values greater than 53 are not recognized. Zero may be used when no week is designated. The manufacturer determines the week numbering system. Manufacturers should use a system in which the week number's integer value increases as the year progresses. If a manufacturer chooses to declare Model Year only, then FFh shall be placed in Address 10 (Week of Manufacture).

11h is one byte representing Year of Manufacture. This value is determined by the actual year of production minus 1990. For example: 2002 – 1990 = 12 or 0Ch. See Table 41.

Address Hex	Example Data		Description	Remarks
	Hex	Dec		
08	0C	12	Manufacturer Name using EISA ID	Example = CEA
09	A1	161		
0A	00	0	Product Code	Used to differentiate between different models from the same manufacturer.
0B	00	0		
0C	00	0	Serial Number	Optional. The serial number can also be stored in a separate descriptor block (see Section 4.3.6).
0D	00	0		
0E	00	0		
0F	00	0		
10	00	0	Week of Manufacture	If this field is unused, the value should be set to 0. If the next field is used for Model Year, then FFh should be set.
11	0C	12	Year of Manufacture/Model Year	Example = 2002

Table 41 Vendor / Product Identification

**A.2.5 EDID Version**

The version of EDID is declared in addresses 12h and 13h. Each address contains one byte of data. The first address contains the version number and the second, the revision number. In the case of EDID version 1.3, the value one (01h) is placed in the first location (i.e., 12h) and three (03h) placed in the second area (13h). No other numbers are allowed for this space. If other numbers are placed in this area, the source device may disregard the whole EDID table. See Table 42.

Address Hex	Example Data		Format	Remarks
	Hex	Dec		
12	01	1	Binary	Version #
13	03	3		Revision #

Table 42 Version of EDID

### A.2.6 Basic Display Parameters and Features

Basic Display Parameters and Features are defined as Video Input Definition, Maximum Horizontal Image Size, Maximum Vertical Image Size, Display Transfer Characteristic (Gamma), and Feature Support. In the following example, each item is allocated one byte and the address range is from 14h to 18h.

14h: Video Input Definition is located at 14h and used to identify the output configuration required by the sink device. For digital displays, including CE devices, the recommended setting is 80h. This value is used to declare that the device supports a digital interface.

15h ~ 16h: The Maximum Horizontal Image Size and Vertical Image Size fields (bytes 15h, 16h) are used to indicate the sink device's screen size and aspect ratio. When known, the maximum physical dimensions of the effective display area should be provided (in these fields, in cm). An important use of these fields is to indicate the aspect ratio of the actual screen. If the aspect ratio of the maximum image size is known, the ratio of the Maximum Size fields should equal that aspect ratio, even if the maximum image size is unknown or variable across different device configurations (such as in a projection system).

The following rules should be used in filling out the Maximum Image Size fields:

- If the aspect ratio is known and the display size is known, then the actual size should be indicated, to the nearest cm.
- If the aspect ratio is known but the size is unknown, any values corresponding to a typical or expected configuration of the display can be used, but the ratio of the Max Horizontal and Vertical fields shall be equal to the aspect ratio.
- If the aspect ratio is unknown, or it is desired that it not be discoverable, then values of 0, 0 should be used.

If the fields are set to zero, the source should not make any assumptions regarding screen size or aspect ratio.

In typical configurations, the image sizes described in each DTD (in bytes at offsets 0Ch, 0Dh, 0Eh, in mm) should correlate to the values in the Maximum Size fields. For instance, a 160 cm by 90 cm display would indicate 1600 mm x 900 mm for all 16:9 video formats and 1200 mm x 900 mm for all 4:3 formats.

For example, data entry into the 15h, 16h EDID bytes may be as summarized in Table 43.

Category of Display	EDID Physical Horizontal Screen Size (cm)	EDID Physical Vertical Screen Size (cm)	Physical AR to be calculated by the source (unitless)
Direct View	Enter dimension in cm	Enter dimension in cm	Source Divides H by V
Rear Projector	Enter dimension in cm	Enter dimension in cm	Source Divides H by V
Front Projector (enter either data row at option of implementer)	Typical dimension in cm	Typical dimension in cm	Source Divides H by V
	Enter 00h	Enter 00h	AR is undefined

Table 43 Example 15h, 16h EDID Screen Size Data and Certain Display Categories

17h: Display Transfer Characteristics (Gamma) could be used by the source device to tailor the video output according to the display device's gamma. The concept of declaring gamma has to do with personal computer CRT displays that accept non-gamma corrected signals. Digital and analog television video signals are gamma corrected according to established industry practices and thus the need to declare CRT gamma is not always necessary. However, this is needed for Personal Computer CRT applications.

CEA-861-C

Although the source device possibly may not need to use the display's gamma value, the correct gamma value of the display device should be present. Since some television CRTs commonly have similar gamma, the value 2.2 is used in this example. The gamma value, itself, is not inserted into the table. Instead, a value equal to (gamma x 100) - 100 is inserted.

18h: Feature Support consists of 8 bits that identify various display or sink device parameters. These include power savings modes based upon VESA Display Power Management Signaling Standard (DPMS), Display Type, Standard Default Color Space, Preferred Timing Mode, and Default Generalized Timing Formula (GTF). In most cases, none of this information is relevant to CE devices and personal computer displays, since GTF is not commonly used. In Table 44, the function of each bit is indicated.

Bits	Feature	Description															
7	Standby	1 = Standby supported, 0 = not supported															
6	Suspend	1 = Suspend supported, 0 = not supported															
5	Active Off	1 = Active Off supported, 0 = not supported															
4 ~ 3	Display Type (4:3)	<table border="1"> <thead> <tr> <th>Bit 4</th> <th>Bit 3</th> <th>Description</th> </tr> </thead> <tbody> <tr> <td>1</td> <td>1</td> <td>Undefined</td> </tr> <tr> <td>1</td> <td>0</td> <td>Non-RGB Display</td> </tr> <tr> <td>0</td> <td>1</td> <td>RGB Display</td> </tr> <tr> <td>0</td> <td>0</td> <td>Monochrome Display</td> </tr> </tbody> </table>	Bit 4	Bit 3	Description	1	1	Undefined	1	0	Non-RGB Display	0	1	RGB Display	0	0	Monochrome Display
Bit 4	Bit 3	Description															
1	1	Undefined															
1	0	Non-RGB Display															
0	1	RGB Display															
0	0	Monochrome Display															
2	Color Space	1 = sRGB supported, 0 = not supported															
1	Preferred Timing	1 = preferred timing is indicated in first detailed timing block (required), 0 = not indicated (not allowed)															
0	Default GTF	1 = GTF supported, 0 = not supported															

**Table 44 Feature Support Detail**

The minimum that a CE device should declare is Display Type and Preferred Timing. In this example, 0Ah is used to designate a RGB display type and a preferred timing descriptor. When the preferred timing descriptor bit is set to one, address locations 36h through 47h should contain valid timing information. This is because the source device is required to recognize the data in the Detailed Timing Descriptor as the preferred timing, and this applies to personal computer implementations as well. No other data is allowed in those locations.



Address Hex	Example Data		Description	Remarks
	Hex	Dec		
14	80	128	Video Input Definition	Example indicates: Digital; VESA DFP1X: not compatible
15	50	80	Max. Horizontal Image Size in cm	CRT devices should list parameters. However, due to projector and auto sizing devices, the system should not make any assumption regarding display size if data not supplied. This example indicates a 16:9 aspect ratio device.
16	2D	45	Max. Vertical Image Size in cm	Optional; See above; This example indicates a 16:9 aspect ratio device.
17	78	120	Gamma: (gamma x 100)-100 = value	Example is: (for gamma = 2.2) (2.2 x 100)-100 = 120
18	0A	10	Feature Support	Example indicates: RGB color Display type; Preferred timing: first detailed timing block; GTF timing: not supported; Standby mode: not supported; Suspend mode: not supported; Active off: not supported

**Table 45 Basic Display Parameters and Features Block**

**A.2.7 Color Characteristics**

Color Characteristics provides information about the display device’s chromaticity and color temperature parameters (white temperature in degrees Kelvin).

Table 47 shows EDID addresses 19h through 22h, which contain data used to describe various chromaticity characteristics; this example uses 9300° K as the white color temperature. These characteristics are represented by 10-bit binary fractions. Bits nine through two of a particular characteristic are stored as a single byte in addresses 1Bh ~ 22h. Bits one to zero of that corresponding characteristic are paired with the lower order bits of other color characteristics to form bytes and are stored in addresses 19h ~ 1Ah. Table 47 shows the arrangement of these fractional binary values by EDID address. In the E-EDID standard, a decimal fraction such as 0.625 is represented by a 10-bit binary value. Each of the bit positions from left to right in the binary value represent powers of 2 from 2<sup>-1</sup> ~ 2<sup>-10</sup>. Table 46 illustrates an example decimal to binary conversion used for these color characteristics. Further explanation can be found in the VESA E-EDID standard (section 3.7).

Value	10-bit Binary	Conversion
0.625	1010000000	0.625
0.340	0101011100	0.33984375
0.155	0010011111	0.1552734375

**Table 46 Binary to Decimal Conversion Example**

How the table is filled is dependent upon the setting of address 18h in the Feature Support section. If sRGB is selected, then all values should be set in accordance to sRGB definition. For displays not supporting the sRGB definition in the example in Table 47.

Address Hex	Example Data		Description	Remarks
	Hex	Dec		
19	0D	13	Red/Green Low Bits	Bits 1-0 of RxRyGxGy = 00001101
1A	C9	201	Blue/White Low Bits	Bits 1-0 of BxByWxWy = 11001001
1B	A0	160	Red-x	Bits 9-2 of 10-bit value 0.625 = 10100000
1C	57	87	Red-y	Bits 9-2 of 10-bit value 0.340 = 01010111
1D	47	71	Green-x	Bits 9-2 of 10-bit value 0.280 = 01000111
1E	98	152	Green-y	Bits 9-2 of 10-bit value 0.595 = 10011000
1F	27	39	Blue-x	Bits 9-2 of 10-bit value 0.155 = 00100111
20	12	18	Blue-y	Bits 9-2 of 10-bit value 0.070 = 00010010
21	48	72	White-x	Bits 9-2 of 10-bit value 0.283 = 01001000
22	4C	76	White-y	Bits 9-2 of 10-bit value 0.298 = 01001100
Note--This data based on a CRT Display with a white point of 9300° K (X = 0.283; Y = 0.298)				

Table 47 Color Characteristics Block

Multiple white points can be specified using the Color Point Monitor Descriptor. However, there is no way to correlate to the individual video formats. Therefore chromaticity specified in Block 0 should be associated with the display device's characteristics; however the White Point data does not. The source device should not rely on the colorimetry information contained in this part of the EDID data structure for CEA-861-C formats. This recommended practice suggests the source device use the colorimetry that has been associated with the format in CEA-861-C when possible. Note that this may not be possible because the source device probably just passes on the video stream.

#### A.2.8 Established Timings

In the example in Table 48, addresses 23h through 25h are used to declare Established Timings. Established Timings are computer display timings recognized by VESA. This table is also used to indicate that the established timings were adjusted and verified at the factory, which means these timings are supported and correctly rendered on the display.

In the example, Table 48 address 23h contains the default 640 x 480p timing and the remaining addresses are not used to list any other timings. Personal Computers, DVI-1.0, Open LDI, CEA-861-B require 640 x 480p (VGA) as a default timing format. This is to insure that all source and sink devices commonly support one format. Other supported or preferred timings may be described in the Standard Timing (see A.2.9) or Detailed Timing Descriptors (see A.2.10). Use of other timings is permissible. See VESA E-EDID Standard section 3.8.1 for a list of possible formats.

Address Hex	Example Data		Description	Remarks
	Hex	Dec		
23	20	32	Established Timing 1	640x480 @60Hz
24	00	0	Established Timing 2	None
25	00	0	Manufacturer's Timing	None

Table 48 Established Timings Block

### A.2.9 Standard Timing ID #1 – 8

Standard timings are those either recognized by VESA through the VESA Discrete Monitor Timing or Generalized Timing Formula standards. The display device should list timings supported. The address range for this portion of the example EDID table is 26h through 35h and the data length is two bytes.

Since CE devices possibly may not support, other than the required VGA format, any of the VESA timings or GTF, the example in Table 49 does not contain any timing information. When no timings are declared, it is necessary to fill each unused byte, of the byte pairs, with 01h as padding. Other padding values are not recognized.

Address Hex	Example Data		Description	Remarks
	Hex	Dec		
26	01	1	Standard Timing ID #1	PC Application
27	01	1		
28	01	1	Standard Timing ID #2	PC Application
29	01	1		
2A	01	1	Standard Timing ID #3	PC Application
2B	01	1		
2C	01	1	Standard Timing ID #4	PC Application
2D	01	1		
2E	01	1	Standard Timing ID #5	PC Application
2F	01	1		
30	01	1	Standard Timing ID #6	PC Application
31	01	1		
32	01	1	Standard Timing ID #7	PC Application
33	01	1		
34	01	1	Standard Timing ID #8	PC Application
35	01	1		

Table 49 Standard Timing ID Block

### A.2.10 Detailed Timing Descriptor Block

The detailed timing section is 72 bytes in length and can be divided into four descriptor blocks, which are each 18 bytes. In the following example, the address ranges for these four blocks are 36h-47h, 48h-59h, 5Ah-6Bh and 6Ch-7Dh. Each of these descriptors contains either detailed timing data (Detailed Timing Descriptor) or other specific types of data as described in the VESA E-EDID standard.

The VESA E-EDID standard allows various descriptor sequences, combinations, or repetitions and source devices should handle descriptors that may appear in any order. The only prescribed constraint is that Detailed Timing Descriptors precede the two required Monitor Descriptors in Block 0. The descriptors require the presence of valid data and no fill patterns are permitted in Block 0. Therefore, the source device should handle these possibilities and requirements accordingly. Blocks used for data, not detailed timing information, have a five byte identifier header that is formatted as follows: 00h, 00h, 00h, <Tag #>, 00h. For more detail regarding 18-byte descriptor tags, please refer to the VESA EDID standard section 3.10.3.

The example in this document configures the four blocks in this order: First Detailed Timing Descriptor, Second Detailed Timing Descriptor, First Monitor Descriptor (Monitor Name), and Second Monitor Descriptor (Monitor Range).

#### A.2.10.1 First Detailed Timing Descriptor

The VESA E-EDID Standard requires that the First Detailed Timing Descriptor be used for the "preferred" or "native" timing and the second detailed timing descriptor for the next preferred timing in descending order. The data in the first timing descriptor should contain binary data conveying preferred timing information.

CEA-861-C

Data locations within the Detailed Timing Descriptors are used to specify the video timing characteristics, image size, and contain flags for identifying interlace/non-interlace formats and sync signal polarities. Designers of source and sink device need to carefully consider these types of data in all implementations.

The example in Table 50 shows the data format for a "preferred" HDTV format 1920 x 1080i and the image size is matched to the screen size of approximately 36 inches diagonal. CEA-861-C recommends listing exact horizontal and vertical dimensions, but at least requires values that describe the aspect ratio. The source box should be capable of using these dimensions to determine aspect ratio. However, some EDID implementations that do not provide horizontal and vertical dimensions for non-CEA-861-C video formats may be encountered. The flags are set to convey an interlaced format and the syncs as separate and of positive polarity.

Address Hex	Example Data		Description	Remarks (Refer to note below for additional details)
	Hex	Dec		
36	01	1	Pixel Clock	74.25MHz
37	1D	29		
38	80	128	H Active	1920 pixels
39	18	24	H Blanking	280 pixels
3A	71	113	H Active: H Blanking	
3B	1C	28	V Active	540 lines
3C	16	22	V Blanking	22 lines
3D	20	32	V Active: V Blanking	
3E	58	88	H Sync Offset	88 pixels
3F	2C	44	H Sync Pulse Width	44 pixels
40	25	37	VS Offset: VS Pulse Width	2 lines, 5 lines
41	00	0	HS Offset: HS Pulse Width: VS Offset: VS Pulse Width	
42	20	32	H Image Size	800mm (lower 8 bits)
43	C2	194	V Image Size	450 mm (lower 8 bits)
44	31	49	H&V Image Size	Upper 4 bits of H Size; Upper 4 bits of V Size
45	00	0	H Border	0 lines
46	00	0	V Border	0 pixels
47	9E	158	Flags	Interlaced, normal display no stereo, digital separate, V-sync polarity is positive, H-sync polarity is positive
NOTE—Some addresses above contain 'composite' bytes representing high and/or low order bits or "nibbles" (4 bits of an 8-bit byte). Please refer to section 3.10.2 of the VESA E-EDID standard for details on these fields.				

**Table 50 First Detailed Timing Descriptor Block (1920x1080i Example)**

**A.2.10.2 Second Detailed Timing Descriptor**

Table 51 contains an example for the second preferred timing using the Second Detailed Timing Descriptor block. This is the EDTV 720 x 480p format that has a 4:3 aspect ratio.

Address Hex	Example Data		Description	Remarks (Refer to note below for additional details)
	Hex	Dec		
48	8C	140	Pixel Clock	27MHz
49	0A	10		
4A	D0	208	H Active	720 pixels
4B	8A	138	H Blanking	138 pixels
4C	20	32	H Active: H Blanking	
4D	E0	224	V Active	480 lines
4E	2D	45	V Blanking	45 lines
4F	10	16	V Active: V Blanking	
50	10	16	H Sync Offset	16 pixels
51	3E	62	H Sync Pulse Width	62 pixels
52	96	150	VS Offset: VS Pulse Width	9 lines, 6 lines
53	00	0	HS Offset: HS Pulse Width: VS Offset: VS Pulse Width	
54	58	88	H Image Size	600 mm (lower 8 bits)
55	C2	194	V Image Size	450 mm (lower 8 bits)
56	21	33	H&V Image Size	Upper 4 bits of H Size; Upper 4 bits of V Size
57	00	0	H Border	0 lines
58	00	0	V Border	0 pixels
59	18	24	Flags	Non-interlaced, normal display no stereo, digital separate, V. and H. sync polarity is negative
NOTE--Some addresses above contain 'composite' bytes representing high and/or low order bits or "nibbles" (4 bits of an 8-bit byte). Please refer to section 3.10.2 of the VESA E-EDID standard for details on these fields.				

**Table 51 Second Detailed Timing Descriptor Block (720x480p, 4:3 Example)**

#### A.2.10.3 First Monitor Descriptor (Monitor Name)

The VESA Standard requires that one of the four 18-byte descriptors be a Monitor Name Descriptor. Here, it is recommended that the third 18-byte descriptor be used as the First Monitor Descriptor or Monitor Name. Examples of these bytes are located at addresses 5Fh through 6Bh. Each location is one byte in length and is used for ASCII character string. In the example contained in Table 52, a fictitious Monitor Name is listed.

Address Hex	Example Data		Description	Remarks
	Hex	Dec		
5A	00	0	Flag (REQUIRED)	Flag = 0000h when block used as descriptor
5B	00	0		
5C	00	0		
5D	FC	252	Data Type Tag	FCh denotes that last 13 bytes of this descriptor block contain Monitor name
5E	00	0	Flag	Flag = 00h when block used as descriptor
5F	4D	77	ASCII coded monitor name (13 bytes max).  If name < 13 bytes, terminate name with 0Ah and fill remainder of 13 bytes with 20h.	Example monitor name:  "MY HDTV"
60	59	89		
61	20	32		
62	48	72		
63	44	68		
64	54	84		
65	56	86		
66	0A	10		
67	20	32		
68	20	32		
69	20	32		
6A	20	32		
6B	20	32		

**Table 52 First Monitor Descriptor Block (Monitor Name)**

#### A.2.10.4 Second Monitor Descriptor (Monitor Range Limits)

The next and last 18-byte descriptor within Block 0 should be used as the Second Monitor Descriptor. In this example, it is the Monitor Range Limit, which is used to designate minimum and maximum parameters for horizontal and vertical frequencies and maximum pixel clock rate. In the following example, the block of data ranges from 6Ch through 7Dh. The data format is binary coded integer.

The first three locations, 6Ch (Flag), 6Dh (Flag), and 6Eh (Reserved Flag) are set to zero. Address 6Fh, a Data Type Flag, should be set to FDh, which means, "monitor range limits, binary coded". For more detail, please refer to the VESA E-EDID standard section 3.10.3. Address 70h is another flag and loaded with zero.

Locations 71h through 75h are used to designate the minimum and maximum parameters for horizontal and vertical frequencies, and maximum pixel clock. Table 53 contains an example for a DTV that supports a 60 Hz vertical refresh rate, 15 kHz up to 46 kHz horizontal rates, which cover the frequencies required for 720 x 480i and 1280 x 720p formats, including 480 x 720p and 1920 x 1080i<sup>16</sup>, and a maximum pixel clock of 80 MHz.

**NOTE**—To reduce the possibility that a source device would mistakenly ignore the frequency range data if the minimum and maximum values were equal, a range of horizontal and vertical frequencies should be declared. For example, if a device supports only 15.75 kHz and 60 Hz timing, it is recommended to list the range as 15 to 16 kHz and 59 to 61 Hz. Source devices may encounter legacy devices that specify the same value for MIN and MAX horizontal and/or vertical ranges.

<sup>16</sup> This frequency range does not necessarily imply multi-scan capability. Due to the 1920 x 1080p format supported by CEA-861-C, a horizontal frequency of 67.5 kHz may be encountered and source devices should be capable of interpreting this information correctly

Address Hex	Example Data		Description	Remarks
	Hex	Dec		
6C	00	0	Flag	Flag = 0000h when block used as descriptor
6D	00	0		
6E	00	0		
6F	FD	253	Data Type Tag	FDh denotes that last 13 bytes of this descriptor block contain Monitor Range limits, binary coded
70	00	0	Flag	Flag = 00h when block used as descriptor
71	3B	59	Min Vertical Rate in Hz	59 HZ
72	3D	61	Max Vertical Rate in Hz	61 Hz
73	0F	15	Min Horizontal Rate in kHz	15KHz
74	2E	46	Max Horizontal Rate in kHz	46KHz
75	08	8	Max Supported pixel clock rate in MHz/10	80MHz
76	00	0	Tag for secondary timing formula (00h=not used)	No secondary timing formula supported
77	0A	10	Put 0Ah after last data byte in block and fill remaining bytes with 20h.	Unused data address'
78	20	32		
79	20	32		
7A	20	32		
7B	20	32		
7C	20	32		
7D	20	32		

**Table 53 Second Monitor Descriptor Block (Monitor Range Limits)**

Address 76h is used as a tag for a secondary generalized timing formula (GTF) and is not typically used for CE devices. In this case, the flag is set to zero. Addresses 77h through 7Dh are related to this tag. The E-EDID standard requires that address 77h contain 0Ah and addresses 78h ~ 7Dh contain 20h when no secondary GTF data is provided.

#### A.2.11 Extension Flag and Checksum

The Extension Flag and Checksum are defined as two-byte data located in address range 7Eh through 7Fh. The Extension Flag is used to indicate that additional blocks are present in the EDID that declare additional video formats and other monitor features.

The Extension Flag is used to declare the number of extensions that exist within the EDID tables. The total number of extensions actually present should equal the number of extensions declared within the base EDID. The number of extensions declared in the base EDID should not include the base EDID but should include the block map. For example: if no extensions exist in the EDID data, then the Extension Flag is set to zero. If a single extension is present, then the flag is set to one. If two extensions exist, then the block map is required by VESA EDID standard to be used and therefore the flag is set to three. The Checksum is set so that the sum of the entire 128-byte block modulus 256 equals 00h.

Table 54 contains example data based upon the tables presented in this document. The Extension Flag at location 7Eh is set to one declaring that Block 1 is present. Since the Extension Flag equals 1 in the example, no other blocks exist. The Checksum is set so that the sum modulus 256 of the entire 128-byte block equals 00h.

Address Hex	Example Data		Description	Remarks
	Hex	Dec		
7E	01	1	Extension Flag	Number of 128 bytes blocks to follow
7F	C3	195	Checksum	Block 0 sum (address 00h~ 7Eh) = 1B3Dh

Table 54 Extension Flag Block

#### A.2.11.1 Block One Details

Although there may be DTV implementations that do not include a CEA Extension or that include it in a block other than Block 1, it is recommended that for a CEA-861-C implementation, that the CEA Extension be included in Block 1. Therefore, the remainder of this Section assumes that Block 1 is a CEA Extension.

The main purpose of the CEA Extension is to provide a place to add additional Detailed Timing Descriptors. However, other VESA-defined 18-byte descriptors are possible (e.g., Monitor Serial Number, Manufacturer Specific, etc.). Source boxes should ignore descriptors that they do not understand. The only descriptors that a CEA-861-C source is required to understand are the Detailed Timing Descriptors, the Monitor Range Limit descriptor, and the Monitor Name Descriptor. Note that the handling of unused descriptors is different in the CEA Extension than it is in Block 0. In Block 0, all four descriptor blocks are required by VESA EDID standard to be filled with valid data, even if it means repeating a timing descriptor. In the CEA Extension, unused descriptor locations are all collected at the end and filled with a fill pattern of 00h. Technically, a descriptor that has the first bytes being 00h would be a manufacturer-defined descriptor with a tag of 00h. It is recommended that manufacturers avoid the use of a 00h tag. Source boxes should verify that there are 18 00h bytes following the last valid descriptor if there is enough room for a descriptor. It is also recommended that the DTV place all of its remaining Detailed Timing Descriptors before other descriptors in the CEA Extension.

Within the CEA Extension, per CEA-861-C, up to six Detailed Timing Descriptors are allowed and may occur in any order. Therefore, source devices should be able to handle any combination or sequence that these Detailed Timing Descriptors may appear. According to CEA-861-C, the timing of highest priority is listed first and subordinate timings in descending order. Source devices should be capable of skipping additional extensions that they may not understand when encountered within Block 1.

#### A.2.12 Overview of Extensions

VESA has assigned Extension Tags used to identify EDID extensions and source devices will encounter some of these extensions. Extensions are identified by the first byte (i.e., Tags). The Tags indicate the type of extension and its purpose. Table 55 lists the Extensions Tag numbers and their description. CEA-861 implementations are required to use Tag = 02h for the CEA Extension Tag and source devices should ignore Tags that are not understood.

Tag	Description
01h	LCD Timings
02h	CEA Extension, previously reserved for VESA additional timing data, however VESA will now use a different tag.
20h	EDID 2.0 Extension
30h	Color information Type 0
40h	DVI feature data
50h	Touch Screen Map
F0h	Block Map
FFh	Extension Defined by monitor manufacturer

Table 55 EDID Extension Tags

The structure of the CEA Extension block, as defined by CEA-861, is shown in Table 56. Please note that other versions of CEA Extensions exist. See Section 7.1 for additional guidance.



Byte #	Value	Description	Format
0	02h	Tag (02h)	
1	01h	Revision Number	
2		Byte number offset <i>d</i> where 18-byte descriptors begin (typically Detailed Timing Descriptors)	<i>d</i> = offset for the byte following the reserved data block. If no data is provided in the reserved data block, then <i>d</i> =4. If no detailed timing descriptions are provided then <i>d</i> =0.
3		Reserved	Set to 00h
4		Start reserved data block	This section was previously reserved for 8 byte-timing descriptors (See EIA/CEA-861) but is currently a reserved data block.
<i>d</i> -1		End of reserved data block.	
<i>d</i>		Start of 18-byte descriptors (typically Detailed Timing Descriptors)	See Section 3.10.2 VESA E-EDID Standard.
<i>d</i> +(18 <i>Xn</i> )-1		End of 18-byte descriptors where <i>n</i> is the number of descriptors included	
<i>d</i> +(18 <i>Xn</i> )	00h	Beginning of Padding	
126	00h	End of Padding	
127		Checksum	xxh = This byte should be programmed such that a one-byte checksum (add all bytes together and modulus 256) of the entire 128 byte block equals "00h".

Table 56 CEA Extension Version 1

### A.2.13 Block One CEA Extension Header

The CEA Extension Header is defined as four-byte data located in address range 80h through 83h. The first byte is the tag used to identify the extension. The number assigned by VESA to this tag is 02h. Following the CEA Extension Tag is the Revision Number location. The data for Revision Number was set according to which standard version the sink device was designed to support. CEA-861, 861-A, and 861-B all had unique number assignments for the Revision Number and this was used to differentiate the level of supported features, such as "InfoPackets", audio, etc. Incrementing the version number is no longer required. CEA-861 formerly required the revision number to be set to 01h, for CEA-861-A it was 02h, and for CEA-861-B it was 03h; however, this is no longer required in CEA-861-C, where only 03h is used. See Section 7.1 for further guidance. Please note that versions 2 and 3 of the CEA Extension are backward compatible with version 1, which is illustrated in this example. Source devices should be prepared to read versions later than version 1 and properly interpret the required 18-byte descriptors.

Following the Revision Number is the Byte Number Offset. This is used to tell where the Detailed Timing Data begins following the Reserved Data Block. The source device should use this byte offset to skip fields that it may not understand within the CEA Extension when encountering versions of this extension that may be newer than its own. CEA-861 DTV Monitors should load location 82 with *d* = 4 if the extension includes 18-byte descriptors. In the following example, the data is listed as 04h, which means there is no data present in the Reserved Data Block and that there are 18-byte descriptors present starting at address 84h. Please refer to CEA-861, CEA-861-A, and CEA-861-B standards for additional details.

Source devices should be aware that for later versions of the CEA Extension, *d* may be set to something other than 0 when no 18-byte descriptors are present. This is an indication that there is data in the reserved data block. In that case, *d* would be set to the location where 18-byte detailed timing descriptors would be located if present. That data should be skipped by a CEA-861-C source device. The presence of padding data for 18-byte descriptors can be used by the source box as an indication whether 18-byte descriptors are present or not.

CEA-861-C

The data at the next address location, 83h in this example, is reserved in the CEA Extension Version 1 (used for an 861 implementation) and is required in 861 to be set to 00h. Newer versions of the CEA Extension include flags in this field (see Sections 7.3 and 7.4). These flags can be ignored by a CEA-861-C source.

Table 57 contains example data based upon the tables presented in this document. In this example, the CEA Extension Tag is located at 80h followed by Revision Number, Byte Number Offset, and Reserved (i.e., 00h). The data is set as prescribed by CEA-861-C.

Address Hex	Example Data		Description	Remarks
	Hex	Dec		
80	02	2	Tag per CEA-861	Tag 02h assigned by VESA to CEA for this extension
81	01	1	01h per CEA-861	Indicates revision of CEA-861 used by this device
82	04	4	04h per CEA-861	04h indicates no data present in Reserved Data Block; 18-byte descriptors ARE present
83	00	0	00h per CEA-861	These bits are utilized as flags in later versions of CEA-861

**Table 57 Block One CEA Extension Header**

**A.2.14 Third Detailed Timing Descriptor**

Following the Extension Flag Table is the next or Third Detailed Timing Descriptor. Table 58 follows the same format as with Table 50 and Table 51. This example is for HD format 1280 x 720p.

Address Hex	Example Data		Description	Remarks (Refer to note below for additional details)
	Hex	Dec		
84	01	1	Pixel Clock	74.25MHz
85	1D	29		
86	00	0	H Active	1280 pixels
87	72	114	H Blanking	370 pixels
88	51	81	H Active: H Blanking	
89	D0	208	V Active	720 lines
8A	1E	30	V Blanking	30 lines
8B	20	32	V Active: V Blanking	
8C	6E	110	H Sync Offset	110 pixels
8D	28	40	H Sync Pulse Width	40 pixels
8E	55	85	VS Offset: VS Pulse Width	
8F	00	0	HS Offset: HS Pulse Width: VS Offset: VS Pulse Width	
90	20	32	H Image Size	800 mm (lower 8 bits)
91	C2	194	V Image Size	450 mm (lower 8 bits)
92	31	49	H&V Image Size	Upper 4 bits of H Size; Upper 4 bits of V Size
93	00	0	H Border	0 pixels
94	00	0	V Border	0 lines
95	1E	30	Flags	Non-interlaced, normal display no stereo, digital separate, H and V sync polarity is positive
NOTE—Some addresses above contain 'composite' bytes representing high and/or low order bits or "nibbles" (4 bits of an 8-bit byte). Please refer to section 3.10.2 of the VESA E-EDID standard for details on these fields.				

**Table 58 Third Detailed Timing Descriptor Block (720p, 16:9 Example)**

**A.2.15 Fourth Detailed Timing Descriptor**

After the Third Detailed Timing Descriptor, the next Detailed Timing Descriptor follows, as indicated in Table 59. As with Table 50, Table 51 and Table 58, the same format is used. This table declares the SD 720 x 480i format, which requires doubling the horizontal pixel count to meet the DVI 1.0 minimum pixel clock frequency.

Address Hex	Example Data		Description	Remarks (Refer to note below for additional details)
	Hex	Dec		
96	8C	140	Pixel Clock	27MHz
97	0A	10		
98	A0	160	H Active	1440 pixels
99	14	20	H Blanking	276 pixels
9A	51	81	H Active: H Blanking	
9B	F0	240	V Active	240 lines
9C	16	22	V Blanking	22 lines
9D	00	0	V Active: V Blanking	
9E	26	38	H Sync Offset	38 pixels
9F	7C	124	H Sync Pulse Width	124 pixels
A0	43	67	VS Offset: VS Pulse Width	
A1	00	0	HS Offset: HS Pulse Width: VS Offset: VS Pulse Width	
A2	58	88	H Image Size	600 mm (lower 8 bits)
A3	C2	194	V Image Size	450 mm (lower 8 bits)
A4	21	33	H&V Image Size	Upper 4 bits of H Size; Upper 4 bits of V Size
A5	00	0	H Border	0 lines
A6	00	0	V Border	0 pixels
A7	98	152	Flags	Interlaced, normal display no stereo, digital separate, V. and H. sync polarity is negative,
NOTE—Some addresses above contain 'composite' bytes representing high and/or low order bits or "nibbles" (4 bits of an 8-bit byte). Please refer to section 3.10.2 of the VESA E-EDID standard for details on these fields.				

**Table 59 Fourth Detailed Timing Descriptor Block (480i, 4:3 Example)**

### A.2.16 Descriptor Defined by Manufacturer

The Descriptor Defined by Manufacturer Table is placed after the last Detailed Timing Descriptor. The manufacturer defines the contents of this descriptor. The tag can be any value between 00h and 0Fh although the use of 00h is not recommended as explained in section 4.3. The example in Table 60 illustrates data that declares a revision number.

Address Hex	Example Data		Description	Remarks
	Hex	Dec		
A8	00	0	Flag	
A9	00	0	Flag	
AA	00	0	Reserved	
AB	01	1	Data Type 01-0F	
AC	00	0	Flag	
AD	52	82	R	
AE	45	69	E	
AF	56	86	V	
B0	31	49	1	
B1	2E	46	.	
B2	30	48	0	
B3	30	48	0	
B4	0A	10		
B5	00	0		
B6	00	0		
B7	00	0		
B8	00	0		
B9	00	0		

Table 60 Descriptor Defined by Manufacturer Block

### A.2.17 Monitor Serial Number

13 bytes of this 18-byte table are allocated for the Monitor Serial number. This table can be used for the manufacturer's convenience. The monitor serial number descriptor uses FFh as the tag. Tags are described in section 4.2.8. The data should be ASCII based. Table 61 contains a fictitious serial number as an example.

Address Hex	Example Data		Description	Remarks
	Hex	Dec		
BA	00	0	Flag	Flag = 0000h when block used as descriptor
BB	00	0		
BC	00	0	Flag (Reserved)	Flag = 00h when block used as descriptor
BD	FF	255	Serial Number Tag	Refer to VESA E-EDID standard, section 3.10.3 for tag definitions
BE	00	0	Flag	
BF	39	57	ASCII serial number data	9
C0	39	57		9
C1	46	70		F
C2	43	67		C
C3	35	53		5
C4	30	48		0
C5	30	48		0
C6	30	48		0
C7	31	49		1
C8	0A	10		ASCII Line Feed
C9	20	32		Padding (ASCII space)
CA	20	32		Padding (ASCII space)
CB	20	32		Padding (ASCII space)

Table 61 Monitor Serial Number Block

**A.2.18 Residual Byte Padding and Check Sum**

CEA-861-C requires that residual addresses contain padding. In this case, 00h is used as padding. Address FFh should contain a one-byte checksum value such that when all bytes of the entire 128-byte block are added, the sum modulus 256 equals 00h. Table 62 illustrates these requirements.

Address Hex	Example Data		Description	Remarks
	Hex	Dec		
CC	00	0	1 <sup>st</sup> padding byte	Padding bytes should = 00h.
CD	00	0	Additional padding bytes	
CE	00	0		
CF	00	0		
D0	00	0		
D1	00	0		
D2	00	0		
D3	00	0		
D4	00	0		
D5	00	0		
D6	00	0		
D7	00	0		
D8	00	0		
D9	00	0		
DA	00	0		
DB	00	0		
DC	00	0		
DD	00	0		
DE	00	0		
DF	00	0		
E0	00	0		
E1	00	0		
E2	00	0		
E3	00	0		
E4	00	0		
E5	00	0		
E6	00	0		
E7	00	0		
E8	00	0		
E9	00	0		
EA	00	0		
EB	00	0		
EC	00	0		
ED	00	0		
EE	00	0		
EF	00	0		
F0	00	0		
F1	00	0		
F2	00	0		
F3	00	0		
F4	00	0		
F5	00	0		
F6	00	0		
F7	00	0		
F8	00	0		
F9	00	0		
FA	00	0		
FB	00	0		
FC	00	0		
FD	00	0		
FE	00	0	Last padding byte	
FF	84	132	Checksum	Block 1 sum (address 80h~ FFh) = 0E7Ch

**Table 62 Residual Byte Stuffing and Check Sum Block**

### A.2.18.1 Hot Plugging Sequence

An important element to proper interpretation of EDID is "Hot Plugging". The following presents a recommendation for achieving consistent results during a Hot Plugging event.

DVI 1.0 defines a Hot Plug Detect (HPD) signal function that indicates to the host whether a monitor is connected. HPD is designed to be powered by the DDC +5V coming from the host, and to be independent of whether the monitor is powered or not. In this way, a host device can detect the monitor and read its characteristics from EDID without the monitor being powered. On a PC, this feature allows the system to load the correct display configuration without delaying the boot process.

In short, in this context, HPD serves as an indication that the EDID is available to be read, however HPD may also have alternative uses. It does not imply any other state of readiness. The relevant definitions from the DVI 1.0 specification are:

- a) Section 2.6: Hot Plug Detect (HPD) – Signal is driven by monitor to enable the system to identify the presence of a monitor.
- b) Section 2.2.9.2: The monitor is required to provide a voltage of greater than +2.4V on the Hot Plug Detect (HPD) pin of the connector only when the EDID data structure is available to be read by the host.

Implementation Note: As an example for hot plug support, a simple monitor implementation of HPD support could be a pull up resistor to the EDID power supply. After HPD goes active, the host is only expected to read EDID and determine that a valid display mode is available and supported.

NOTE—Whenever the EDID information in a device changes for any reason (e.g. if the EDID was updated, or is capable of dynamically changing its information content), the receiving device pulses HPD low for at least 100ms. This recommendation follows from the HDCP repeater implementation requirement that HDCP repeaters pulse HPD low for at least 100ms to indicate the connection of a new device or disconnection of an existing one.

### A.3 Complete Example EDID Table (Informative)

Address Hex	Example Data		Name of Block	Description	Remarks
	Hex	Dec			
00	00	0	Block Zero Header		Fixed Value
01	FF	255			
02	FF	255			
03	FF	255			
04	FF	255			
05	FF	255			
06	FF	255			
07	00	0			
08	0C	12	Vendor / Product ID	Manufacturer Name	CEA
09	A1	161		Product Code	Used to differentiate between different models from the same manufacturer.
0A	00	00		Serial Number	Optional. The serial number can also be stored in a separate descriptor block
0B	00	0			
0C	00	00			
0D	00	00			
0E	00	00		Week of Manufacture	Optional. If this field is unused, the value should be set to 0.
0F	00	00			
10	00	0		Year of Manufacture	Year 2002
11	0C	12			

Table 63 Complete EDID Example

Address Hex	Example Data Hex    Dec		Name of Block	Description	Remarks
12	01	1	<b>EDID Structure Version / Revision</b>	Version #	1
13	03	3		Revision #	3
14	80	128	<b>Basic Display Parameters / Features</b>	Video Input Definition	Digital, VESA DFP1X : not compatible
15	50	80		Max. Horizontal Image Size in cm	Optional. The system should not make any assumption regarding display size
16	2D	45		Max. Vertical Image Size in cm	Optional. See above.
17	78	120		Gamma: (gamma x 100)-100 = value	Example is: (gamma = 2.2) (2.2 x 100)-100 = 120
18	0A	10		Feature Support	0x0A denotes: RGB color Display type, preferred timing: first detailed timing block. GTF timing: not supported. Standby mode: not supported, suspend mode: not supported, active off: not supported
19	0D	13		<b>Color Characteristics</b>	Red/Green Low Bits
1A	C9	201	Blue/White Low Bits		
1B	A0	160	Red-x		0.625
1C	57	87	Red-y		0.340
1D	47	71	Green-x		0.280
1E	98	152	Green-y		0.595
1F	27	39	Blue-x		0.155
20	12	18	Blue-y		0.070
21	48	72	White-x		0.283
22	4C	76	White-y		0.298
23	20	32	<b>Established Timings</b>	Timing 1	640x480 @60Hz
24	00	0		Timing 2	None
25	00	0		Manufacturer's Reserved Timing	None
26	01	1	<b>Standard Timing ID # 1-8</b>	Standard Timing ID #1	PC Applications
27	01	1		Standard Timing ID #2	PC Applications
28	01	1		Standard Timing ID #3	PC Applications
29	01	1		Standard Timing ID #4	PC Applications
2A	01	1		Standard Timing ID #5	PC Applications
2B	01	1		Standard Timing ID #6	PC Applications
2C	01	1		Standard Timing ID #7	PC Applications
2D	01	1		Standard Timing ID #8	PC Applications
2E	01	1			
2F	01	1			
30	01	1	<b>First Detailed Timing Descriptor (Preferred)</b>	Pixel Clock	74.25MHz
31	01	1		H Active	1920 pixels
32	01	1		H Blanking	280 pixels
33	01	1		H Active: H Blanking	
34	01	1		V Active	540 lines
35	01	1		V Blanking	22 lines
36	01	1			
37	1D	29			
38	80	128			
39	18	24			
3A	71	113			
3B	1C	28			
3C	16	22			



3D	20	32		V Active: V Blanking		
3E	58	88		H Sync Offset	88 pixels	
3F	2C	44		H Sync Pulse Width	44 pixels	
40	25	37		VS Offset: VS Pulse Width	2 lines, 5 lines	
41	00	0		HS Offset: HS Pulse Width: VS Offset: VS Pulse Width		
42	20	32		H Image Size	800 mm	
43	C2	194		V Image Size	450mm	
44	31	49		H&V Image Size		
45	00	0		H Border	0 lines	
46	00	0		V Border	0 pixels	
47	9E	158		Flags	Interlaced, normal display no stereo, digital separate, V-sync polarity is positive, H-sync polarity is positive	
48	8C	140		<b>Second Detailed Timing Descriptor</b>	Pixel Clock	27MHz
49	0A	10			H Active	720 pixels
4A	D0	208			H Blanking	138 pixels
4B	8A	138	H Active: H Blanking			
4C	20	32	V Active		480 lines	
4D	E0	224	V Blanking		45 lines	
4E	2D	45	V Active: V Blanking			
4F	10	16	H Sync Offset		16 pixels	
50	10	16	H Sync Pulse Width		62 pixels	
51	3E	62	VS Offset: VS Pulse Width		9 lines, 6 lines	
52	96	150	HS Offset: HS Pulse Width: VS Offset: VS Pulse Width			
53	00	0	H Image Size		600 mm	
54	58	88	V Image Size		450 mm	
55	C2	194	H&V Image Size			
56	21	33	H Border	0 lines		
57	00	0	V Border	0 pixels		
58	00	0	Flags	non interlaced, normal display no stereo, digital separate, V. and H. sync polarity is negative		
59	18	24	<b>Monitor Descriptor (Monitor Name) Mandatory</b>	Flag		
5A	00	0		Flag (Reserved)		
5B	00	0		Data Type Tag	Monitor name type	
5C	00	0		Flag		
5D	FC	252		M		
5E	00	0		Y		
5F	4D	77				
60	59	89		H		
61	20	32		D		
62	48	72		T		
63	44	68		V		
64	54	84				
65	56	86				
66	0A	10				
67	20	32				
68	20	32				
69	20	32				
6A	20	32				
6B	20	32				
6C	00	0	<b>Second Monitor</b>	Flag		
6D	00	0				

CEA-861-C

6E	00	0	<b>Descriptor Mandatory</b> (range limits, binary coded)	Flag (Reserved)	
6F	FD	253		Data Type Tag	Monitor Range limits, binary coded, mandatory block
70	00	0		Flag	
71	3B	59		Min Vertical Rate in Hz	59 HZ
72	3D	61		Max Vertical Rate in Hz	61 Hz
73	0F	15		Min Horizontal Rate in kHz	15KHz
74	2E	46		Max Horizontal Rate in kHz	46KHz
75	08	8		Max Supported pixel clock rate in MHz/10	80MHz
76	00	0		Tag for secondary timing formula (00h=not used)	No secondary timing formula supported
77	0A	10		Fixed	
78	20	32		Fixed	
79	20	32		Fixed	
7A	20	32		Fixed	
7B	20	32		Fixed	
7C	20	32		Fixed	
7D	20	32		Fixed	
7E	01	1	<b>Extension Flag</b>	Number of 128 bytes blocks to follow	
7F	C3	195		Checksum	Block 0 sum = 1B3Dh
80	02	2	<b>CEA Extension Header</b>	Tag	Block One
81	01	1		01h by 861	Revision Number
82	04	4		04h, no data in Reserved	Byte Offset
83	00	0		00h by 861	
84	01	1	<b>Third Detailed Timing Descriptor</b>	Pixel Clock	74.25MHz
85	1D	29		H Active	1280 pixels
86	00	0		H Blanking	370 pixels
87	72	114		H Active: H Blanking	
88	51	81		V Active	720 lines
89	D0	208		V Blanking	30 lines
8A	1E	30		V Active: V Blanking	
8B	20	32		H Sync Offset	110 pixels
8C	6E	110		H Sync Pulse Width	40 pixels
8D	28	40		VS Offset: VS Pulse Width	
8E	55	85		HS Offset: HS Pulse Width: VS Offset: VS Pulse Width	
8F	00	0		H Image Size	800 mm
90	20	32		V Image Size	450 mm
91	C2	194		H&V Image Size	
92	31	49		H Border	0 pixels
93	00	0		V Border	0 lines
94	00	0	Flags	Non-interlaced, normal display no stereo, digital separate, H and V sync polarity is positive	
95	1E	30	<b>Fourth Detailed Timing Descriptor</b>	Pixel Clock	27MHz
96	8C	140		H Active	1440 pixels
97	0A	10		H Blanking	276 pixels
98	A0	160		H Active: H Blanking	
99	14	20		V Active	240 lines
9A	51	81		V Blanking	22 lines
9B	F0	240		V Active: V Blanking	
9C	16	22		H Sync Offset	38 pixels
9D	00	0			
9E	26	38			

9F	7C	124		H Sync Pulse Width	124 pixels
A0	43	67		VS Offset: VS Pulse Width	
A1	00	0		HS Offset: HS Pulse Width: VS Offset: VS Pulse Width	
A2	58	88		H Image Size	600 mm
A3	C2	194		V Image Size	450 mm
A4	21	33		H&V Image Size	
A5	00	0		H Border	0 lines
A6	00	0		V Border	0 pixels
A7	98	152	Flags	interlaced, normal display no stereo, digital separate, V. and H. sync polarity is negative,	
A8	00	0	<b>Descriptor Defined by Manufacturer</b>	Flag	
A9	00	0		Flag	
AA	00	0		Reserved	
AB	01	1		Data Type 01-0F	
AC	00	0		Flag	
AD	52	82		R	
AE	45	69		E	
AF	56	86		V	
B0	31	49		1	
B1	2E	46		.	
B2	30	48		0	
B3	30	48		0	
B4	0A	10			
B5	00	0			
B6	00	0			
B7	00	0			
B8	00	0			
B9	00	0			
BA	00	0	<b>Monitor Serial Number (ASCII, 13 bytes max)</b>		
BB	00	0			
BC	00	0			
BD	FF	255		Serial Number Tag	
BE	00	0			
BF	39	57		9	
C0	39	57		9	
C1	46	70		F	
C2	43	67		C	
C3	35	53		5	
C4	30	48		0	
C5	30	48		0	
C6	30	48	0		
C7	31	49	1		
C8	0A	10			
C9	20	32			
CA	20	32			
CB	20	32			
CC	00	0	<b>Residual Byte Padding</b>		
CD	00	0			
CE	00	0			
CF	00	0			
D0	00	0			
D1	00	0			
D2	00	0			
D3	00	0			
D4	00	0			
D5	00	0			

CEA-861-C

D6	00	0		
D7	00	0		
D8	00	0		
D9	00	0		
DA	00	0		
DB	00	0		
DC	00	0		
DD	00	0		
DE	00	0		
DF	00	0		
E0	00	0		
E1	00	0		
E2	00	0		
E3	00	0		
E4	00	0		
E5	00	0		
E6	00	0		
E7	00	0		
E8	00	0		
E9	00	0		
EA	00	0		
EB	00	0		
EC	00	0		
ED	00	0		
EE	00	0		
EF	00	0		
F0	00	0		
F1	00	0		
F2	00	0		
F3	00	0		
F4	00	0		
F5	00	0		
F6	00	0		
F7	00	0		
F8	00	0		
F9	00	0		
FA	00	0		
FB	00	0		
FC	00	0		
FD	00	0		
FE	00	0		
FF	84	132	Checksum	Block 1 sum = 0E7Ch

## A.4 Example EDID Detailed Timing Descriptors

Byte# (HEX)	Function	Value (HEX)	Value (binary)	Notes
36	Pixel Clock/10,000 (LSB stored first)	01		Pixel Clock = 74.25MHz
37		1D		
38	Horizontal Active Pixels (lower 8 bits)	00		hor. active pixels = 1280 = 500h
39	Horizontal Blanking Pixels (lower 8 bits)	72		hor. blanking pixels = 370 = 172h
3A	Horizontal Active and Blanking Pixels (upper nibble = upper 4 bits of active) (lower nibble = upper 4 bits of blanking)	51		
3B	Vertical Active Lines, lower 8 bits	D0		vert. active lines = 720 = 2D0h
3C	Vertical Blanking Lines, lower 8 bits	1E		vert. blanking lines = 30 = 1Eh
3D	Vertical Active: Vertical Blanking (upper nibble = upper 4 bits of active) (lower nibble = upper 4 bits of blanking)	20		
3E	Horizontal sync. offset (pixels) (from blanking starts, lower 8 bits)	6E		offset = 110 pixels = 6Eh
3F	Horizontal sync pulse width (pixels) (lower 8 bits)	28		width = 40 pixels = 28h
40	Vert sync offset; Vert sync pulse width (upper nibble = lines, lower 4 bits of vertical sync offset) (lower nibble = lines, lower 4 bits of vertical sync pulse width)	55		vert sync. offset = 5 lines vert. sync width = 5 lines
41	bits 7,6: upper 2 bits of Hor. sync. offset bits 5,4: upper 2 bits of Hor. sync pulse width bits 3,2: upper 2 bits of vert sync offset bits 1,0: upper 2 bits of vert. sync pulse width	00	00000000	
42	Horizontal Image Size (mm, lower 8 bits)	C4		Hor. Image size = 708mm = 2C4h
43	Vertical Image Size (mm, lower 8 bits)	8E		Vert. Image Size = 398mm = 18Eh
44	Horizontal and Vertical Image Size (upper nibble = upper 4 bits of horiz.) (lower nibble = upper 4 bits of vert.)	21		
45	Horizontal Border <sup>17</sup> (pixels)	0		Shall be 0
46	Vertical Border (pixels)	0		Shall be 0
47	Flags (bit 7 = non-interlaced; bit 5,6 = normal display; bit 1, 2, 3,4 = sync description; bit 0 = don't care)	1E	00011110	Flag = non- interlaced; non- stereo; digital separate; positive V sync; positive H sync

Table 64 Example EDID Detailed Timing Descriptor for 1280x720p (60 Hz, 16:9)

<sup>17</sup> A border is the portion of the display screen that is outside the addressable area of the display device screen; or the portion of the video signal that is not intended to be driven or scanned, when sent to a display electronics [8]. Borders are part of the blanking time. For CE products, border will not be used and in the 18 byte detailed timing descriptor, the horizontal and vertical borders shall be set to zero.

Byte# (HEX)	Function	Value (HEX)	Value (binary)	Notes
3 6	Pixel Clock/10,000 (LSB stored first)	01		Pixel Clock = 74.25MHz
3 7		1D		
3 8	Horizontal Active Pixels (lower 8 bits)	80		hor. active pixels = 1920 = 780h
3 9	Horizontal Blanking Pixels (lower 8 bits)	18		hor. blanking pixels = 280 = 118h
3 A	Horizontal Active and Blanking Pixels (upper nibble = upper 4 bits of active) (lower nibble = upper 4 bits of blanking)	71		
3 B	Vertical Active Lines, lower 8 bits	1C		vert. active lines = 540 = 21Ch
3 C	Vertical Blanking Lines, lower 8 bits	16		vert. blanking lines = 22 = 16h <sup>18</sup>
3 D	Vertical Active: Vertical Blanking (upper nibble = upper 4 bits of active) (lower nibble = upper 4 bits of blanking)	20		
3 E	Horizontal sync. offset (pixels) (from blanking starts, lower 8 bits)	58		offset = 88 pixels = 58h
3 F	Horizontal sync pulse width (pixels) (lower 8 bits)	2C		width = 44 pixels = 2Ch
4 0	Vert sync offset; Vert sync pulse width (upper nibble = lines, lower 4 bits of vertical sync offset) (lower nibble = lines, lower 4 bits of vertical sync pulse width)	25		vert sync. offset = 2 lines <sup>19</sup> vert. sync width = 5 lines
4 1	bits 7,6: upper 2 bits of Hor. sync. offset bits 5,4: upper 2 bits of Hor. sync pulse width bits 3,2: upper 2 bits of vert sync offset bits 1,0: upper 2 bits of vert. sync pulse width	00	00000000	
4 2	Horizontal Image Size (mm, lower 8 bits)	C4		Hor. Image size = 708mm = 2C4h <sup>20</sup>
4 3	Vertical Image Size (mm, lower 8 bits)	8E		Vert. Image Size = 398mm = 18Eh
4 4	Horizontal and Vertical Image Size (upper nibble = upper 4 bits of horiz.) (lower nibble = upper 4 bits of vert.)	21		
4 5	Horizontal Border (pixels)	0		Shall be 0
4 6	Vertical Border (pixels)	0		Shall be 0
4 7	Flags (bit 7 = interlaced; bit 5,6 = normal display; bit 1, 2, 3,4 = sync description; bit 0 = don't care)	9E	10011110	Flag = interlaced; non-stereo; digital separate; positive V sync; positive H sync

Table 65 Example EDID Detailed Timing Descriptor for 1920x1080i (60 Hz, 16:9)

<sup>18</sup> For interlaced display: Field 1 vertical blanking = Vertical Blanking Lines. Field 2 vertical blanking = Vertical Blanking Lines + 1 line.

<sup>19</sup> For interlaced display: Field 1 vertical offset = Vertical Sync Offset. Field 2 vertical offset = Vertical Sync Offset + 0.5 lines.

<sup>20</sup> Image size is display dependent. Ratio of Horizontal Image Size to Vertical Image Size shall be 16:9 or 4:3.

Byte# (HEX)	Function	Value (HEX)	Value (binary)	Notes
36	Pixel Clock/10,000 (LSB stored first)	8C		Pixel Clock = 27.00MHz
37		0A		
38	Horizontal Active Pixels (lower 8 bits)	D0		hor. active pixels = 720 = 2D0h
39	Horizontal Blanking Pixels (lower 8 bits)	8A		hor. blanking pixels = 138 = 8Ah
3A	Horizontal Active and Blanking Pixels (upper nibble = upper 4 bits of active) (lower nibble = upper 4 bits of blanking)	20		
3B	Vertical Active Lines, lower 8 bits	E0		vert. active lines = 480 = 1E0h
3C	Vertical Blanking Lines, lower 8 bits	2D		vert. blanking lines = 45 = 2Dh
3D	Vertical Active: Vertical Blanking (upper nibble = upper 4 bits of active) (lower nibble = upper 4 bits of blanking)	10		
3E	Horizontal sync. offset (pixels) (from blanking starts, lower 8 bits)	10		offset = 16 pixels = 10h
3F	Horizontal sync pulse width (pixels) (lower 8 bits)	3E		width = 62 pixels = 3Eh
40	Vert sync offset; Vert sync pulse width (upper nibble = lines, lower 4 bits of vertical sync offset) (lower nibble = lines, lower 4 bits of vertical sync pulse width)	96		vert sync. offset = 9 lines vert. sync width = 6 lines
41	bits 7,6: upper 2 bits of Hor. sync. offset bits 5,4: upper 2 bits of Hor. sync pulse width bits 3,2: upper 2 bits of vert sync offset bits 1,0: upper 2 bits of vert. sync pulse width	00	00000000	
42	Horizontal Image Size (mm, lower 8 bits)	13		Hor. Image size = 531mm = 213h
43	Vertical Image Size (mm, lower 8 bits)	8E		Vert. Image Size = 398mm = 18Eh (4:3 in this case).
44	Horizontal and Vertical Image Size (upper nibble = upper 4 bits of horiz.) (lower nibble = upper 4 bits of vert.)	21		
45	Horizontal Border (pixels)	0		Shall be 0
46	Vertical Border (pixels)	0		Shall be 0
47	Flags (bit 7 = non-interlaced; bit 5,6 = normal display; bit 1, 2, 3,4 = sync description; bit 0 = don't care)	18	00011000	Flag = non-interlaced; non-stereo; digital separate; negative V sync; negative H sync

Table 66 Example EDID Detailed Timing Descriptor for 720x480p (59.94Hz, 4:3)

Byte# (HEX)	Function	Value (HEX)	Value (binary)	Notes
3 6	Pixel Clock/10,000 (LSB stored first)	8 C		Pixel Clock = 27.00MHz
3 7		0 A		
3 8	Horizontal Active Pixels (lower 8 bits)	D 0		hor. active pixels = 720 = 2D0h
3 9	Horizontal Blanking Pixels (lower 8 bits)	8 A		hor. blanking pixels = 138 = 8Ah
3 A	Horizontal Active and Blanking Pixels (upper nibble = upper 4 bits of active) (lower nibble = upper 4 bits of blanking)	2 0		
3 B	Vertical Active Lines, lower 8 bits	E 0		vert. active lines = 480 = 1E0h
3 C	Vertical Blanking Lines, lower 8 bits	2 D		vert. blanking lines = 45 = 2Dh
3 D	Vertical Active: Vertical Blanking (upper nibble = upper 4 bits of active) (lower nibble = upper 4 bits of blanking)	1 0		
3 E	Horizontal sync. offset (pixels) (from blanking starts, lower 8 bits)	1 0		offset = 16 pixels = 10h
3 F	Horizontal sync pulse width (pixels) (lower 8 bits)	3 E		width = 62 pixels = 3Eh
4 0	Vert sync offset; Vert sync pulse width (upper nibble = lines, lower 4 bits of vertical sync offset) (lower nibble = lines, lower 4 bits of vertical sync pulse width)	9 6		vert sync. offset = 9 lines vert. sync width = 6 lines
4 1	bits 7,6: upper 2 bits of Hor. sync. offset bits 5,4: upper 2 bits of Hor. sync pulse width bits 3,2: upper 2 bits of vert sync offset bits 1,0: upper 2 bits of vert. sync pulse width	0 0	0 0 0 0 0 0 0 0	
4 2	Horizontal Image Size (mm, lower 8 bits)	C 4		Hor. Image size = 708mm = 2C4h
4 3	Vertical Image Size (mm, lower 8 bits)	8 E		Vert. Image Size = 398mm = 18Eh (16:9 in this case).
4 4	Horizontal and Vertical Image Size (upper nibble = upper 4 bits of horiz.) (lower nibble = upper 4 bits of vert.)	2 1		
4 5	Horizontal Border (pixels)	0		Shall be 0
4 6	Vertical Border (pixels)	0		Shall be 0
4 7	Flags (bit 7 = non-interlaced; bit 5,6 = normal display; bit 1, 2, 3,4 = sync description; bit 0 = don't care)	1 8	0 0 0 1 1 0 0 0	Flag = non-interlaced; non-stereo; digital separate; negative V sync; negative H sync

Table 67 Example EDID Detailed Timing Descriptor for 720x480p (59.94Hz, 16:9)



Byte# (HEX)	Function	Value (HEX)	Value (binary)	Notes
36	Pixel Clock/10,000 (LSB stored first)	8C		Pixel Clock = 27.00MHz
37		0A		
38	Horizontal Active Pixels (lower 8 bits)	A0		hor. active pixels = 1440 = 5A0h
39	Horizontal Blanking Pixels (lower 8 bits)	14		hor. blanking pixels = 276 = 114h
3A	Horizontal Active and Blanking Pixels (upper nibble = upper 4 bits of active) (lower nibble = upper 4 bits of blanking)	51		
3B	Vertical Active Lines, lower 8 bits	F0		vert. active lines = 240 = F0h
3C	Vertical Blanking Lines, lower 8 bits	16		vert. blanking lines = 22 = 16h
3D	Vertical Active: Vertical Blanking (upper nibble = upper 4 bits of active) (lower nibble = upper 4 bits of blanking)	00		
3E	Horizontal sync. offset (pixels) (from blanking starts, lower 8 bits)	26		offset = 38 pixels = 26h
3F	Horizontal sync pulse width (pixels) (lower 8 bits)	7C		width = 124 pixels = 7Ch
40	Vert sync offset; Vert sync pulse width (upper nibble = lines, lower 4 bits of vertical sync offset) (lower nibble = lines, lower 4 bits of vertical sync pulse width)	43		vert sync. offset = 4 lines vert. sync width = 3 lines
41	bits 7,6: upper 2 bits of Hor. sync. offset bits 5,4: upper 2 bits of Hor. sync pulse width bits 3,2: upper 2 bits of vert sync offset bits 1,0: upper 2 bits of vert. sync pulse width	00	00000000	
42	Horizontal Image Size (mm, lower 8 bits)	13		Hor. Image size = 531mm = 213h
43	Vertical Image Size (mm, lower 8 bits)	8E		Vert. Image Size = 398mm = 18Eh (4:3 in this case).
44	Horizontal and Vertical Image Size (upper nibble = upper 4 bits of horiz.) (lower nibble = upper 4 bits of vert.)	21		
45	Horizontal Border (pixels)	0		Shall be 0
46	Vertical Border (pixels)	0		Shall be 0
47	Flags (bit 7 = non-interlaced; bit 5,6 = normal display; bit 1, 2, 3,4 = sync description; bit 0 = don't care)	98	10011000	Flag = interlaced; non-stereo; digital separate; negative V sync; negative H sync

Table 68 Example EDID Detailed Timing Descriptor for 720x480i (59.94Hz, 4:3)

Byte# (HEX)	Function	Value (HEX)	Value (binary)	Notes
36	Pixel Clock/10,000 (LSB stored first)	8C		Pixel Clock = 27.00MHz
37		0A		
38	Horizontal Active Pixels (lower 8 bits)	A0		hor. active pixels = 1440 = 5A0h
39	Horizontal Blanking Pixels (lower 8 bits)	14		hor. blanking pixels = 276 = 114h
3A	Horizontal Active and Blanking Pixels (upper nibble = upper 4 bits of active) (lower nibble = upper 4 bits of blanking)	51		
3B	Vertical Active Lines, lower 8 bits	F0		vert. active lines = 240 = F0h
3C	Vertical Blanking Lines, lower 8 bits	16		vert. blanking lines = 22 = 16h
3D	Vertical Active: Vertical Blanking (upper nibble = upper 4 bits of active) (lower nibble = upper 4 bits of blanking)	00		
3E	Horizontal sync. offset (pixels) (from blanking starts, lower 8 bits)	26		offset = 38 pixels = 26h
3F	Horizontal sync pulse width (pixels) (lower 8 bits)	7C		width = 124 pixels = 7Ch
40	Vert sync offset; Vert sync pulse width (upper nibble = lines, lower 4 bits of vertical sync offset) (lower nibble = lines, lower 4 bits of vertical sync pulse width)	43		vert sync. offset = 4 lines vert. sync width = 3 lines
41	bits 7,6: upper 2 bits of Hor. sync. offset bits 5,4: upper 2 bits of Hor. sync pulse width bits 3,2: upper 2 bits of vert sync offset bits 1,0: upper 2 bits of vert. sync pulse width	00	00000000	
42	Horizontal Image Size (mm, lower 8 bits)	C4		Hor. Image size = 708mm = 2C4h
43	Vertical Image Size (mm, lower 8 bits)	8E		Vert. Image Size = 398mm = 18Eh (16:9 in this case).
44	Horizontal and Vertical Image Size (upper nibble = upper 4 bits of horiz.) (lower nibble = upper 4 bits of vert.)	21		
45	Horizontal Border (pixels)	0		Shall be 0
46	Vertical Border (pixels)	0		Shall be 0
47	Flags (bit 7 = non-interlaced; bit 5,6 = normal display; bit 1, 2, 3,4 = sync description; bit 0 = don't care)	98	10011000	Flag = interlaced; non-stereo; digital separate; negative V sync; negative H sync

Table 69 Example EDID Detailed Timing Descriptor for 720x480i (59.94Hz, 16:9)

Byte# (HEX)	Function	Value (HEX)	Value (binary)	Notes
36	Pixel Clock/10,000 (LSB stored first)	01		Pixel Clock = 74.25MHz
37		1D		
38	Horizontal Active Pixels (lower 8 bits)	00		hor. active pixels = 1280 = 500h
39	Horizontal Blanking Pixels (lower 8 bits)	BC		hor. blanking pixels = 700 = 2BCh
3A	Horizontal Active and Blanking Pixels (upper nibble = upper 4 bits of active) (lower nibble = upper 4 bits of blanking)	52		
3B	Vertical Active Lines, lower 8 bits	D0		vert. active lines = 720 = 2D0h
3C	Vertical Blanking Lines, lower 8 bits	1E		vert. blanking lines = 30 = 1Eh
3D	Vertical Active: Vertical Blanking (upper nibble = upper 4 bits of active) (lower nibble = upper 4 bits of blanking)	20		
3E	Horizontal sync. offset (pixels) (from blanking starts, lower 8 bits)	B8		offset = 440 pixels = 1B8h
3F	Horizontal sync pulse width (pixels) (lower 8 bits)	28		width = 40 pixels = 28h
40	Vert sync offset; Vert sync pulse width (upper nibble = lines, lower 4 bits of vertical sync offset) (lower nibble = lines, lower 4 bits of vertical sync pulse width)	55		vert sync. offset = 5 lines vert. sync width = 5 lines
41	bits 7,6: upper 2 bits of Hor. sync. offset bits 5,4: upper 2 bits of Hor. sync pulse width bits 3,2: upper 2 bits of vert sync offset bits 1,0: upper 2 bits of vert. sync pulse width	40	01000000	
42	Horizontal Image Size (mm, lower 8 bits)	C4		Hor. Image size = 708mm = 2C4h
43	Vertical Image Size (mm, lower 8 bits)	8E		Vert. Image Size = 398mm = 18Eh
44	Horizontal and Vertical Image Size (upper nibble = upper 4 bits of horiz.) (lower nibble = upper 4 bits of vert.)	21		
45	Horizontal Border (pixels)	0		Shall be 0
46	Vertical Border (pixels)	0		Shall be 0
47	Flags (bit 7 = non-interlaced; bit 5,6 = normal display; bit 1, 2, 3,4 = sync description; bit 0 = don't care)	1E	00011110	Flag = non- interlaced; non-stereo; digital separate; positive V sync; positive H sync

**Table 70 Example EDID Detailed Timing Descriptor for 1280x720p (50 Hz, 16:9)**

Byte# (HEX)	Function	Value (HEX)	Value (binary)	Notes
3 6	Pixel Clock/10,000 (LSB stored first)	0 1		Pixel Clock = 74.25MHz
3 7		1 D		
3 8	Horizontal Active Pixels (lower 8 bits)	8 0		hor. active pixels = 1920 = 780h
3 9	Horizontal Blanking Pixels (lower 8 bits)	D 0		hor. blanking pixels = 720 = 2D0h
3 A	Horizontal Active and Blanking Pixels (upper nibble = upper 4 bits of active) (lower nibble = upper 4 bits of blanking)	7 2		
3 B	Vertical Active Lines, lower 8 bits	1 C		vert. active lines = 540 = 21Ch
3 C	Vertical Blanking Lines, lower 8 bits	1 6		vert. blanking lines = 22 = 16h
3 D	Vertical Active: Vertical Blanking (upper nibble = upper 4 bits of active) (lower nibble = upper 4 bits of blanking)	2 0		
3 E	Horizontal sync. offset (pixels) (from blanking starts, lower 8 bits)	1 0		offset = 528 pixels = 210h
3 F	Horizontal sync pulse width (pixels) (lower 8 bits)	2 C		width = 44 pixels = 2Ch
4 0	Vert sync offset; Vert sync pulse width (upper nibble = lines, lower 4 bits of vertical sync offset) (lower nibble = lines, lower 4 bits of vertical sync pulse width)	2 5		vert sync. offset = 2 lines vert. sync width = 5 lines
4 1	bits 7,6: upper 2 bits of Hor. sync. offset bits 5,4: upper 2 bits of Hor. sync pulse width bits 3,2: upper 2 bits of vert sync offset bits 1,0: upper 2 bits of vert. sync pulse width	8 0	1 0 0 0 0 0 0 0	
4 2	Horizontal Image Size (mm, lower 8 bits)	C 4		Hor. Image size = 708mm = 2C4h
4 3	Vertical Image Size (mm, lower 8 bits)	8 E		Vert. Image Size = 398mm = 18Eh
4 4	Horizontal and Vertical Image Size (upper nibble = upper 4 bits of horiz.) (lower nibble = upper 4 bits of vert.)	2 1		
4 5	Horizontal Border (pixels)	0		Shall be 0
4 6	Vertical Border (pixels)	0		Shall be 0
4 7	Flags (bit 7 = interlaced; bit 5,6 = normal display; bit 1, 2, 3,4 = sync description; bit 0 = don't care)	9 E	1 0 0 1 1 1 1 0	Flag = interlaced; non-stereo; digital separate; positive V sync; positive H sync

Table 71 Example EDID Detailed Timing Descriptor for 1920x1080i (50 Hz, 16:9)

Byte# (HEX)	Function	Value (HEX)	Value (binary)	Notes
36	Pixel Clock/10,000 (LSB stored first)	8C		Pixel Clock = 27.00MHz
37		0A		
38	Horizontal Active Pixels (lower 8 bits)	D0		hor. active pixels = 720 = 2D0h
39	Horizontal Blanking Pixels (lower 8 bits)	90		hor. blanking pixels = 144 = 90h
3A	Horizontal Active and Blanking Pixels (upper nibble = upper 4 bits of active) (lower nibble = upper 4 bits of blanking)	20		
3B	Vertical Active Lines, lower 8 bits	40		vert. active lines = 576 = 240h
3C	Vertical Blanking Lines, lower 8 bits	31		vert. blanking lines = 49 = 31h
3D	Vertical Active: Vertical Blanking (upper nibble = upper 4 bits of active) (lower nibble = upper 4 bits of blanking)	20		
3E	Horizontal sync. offset (pixels) (from blanking starts, lower 8 bits)	0C		offset = 12 pixels = 0Ch
3F	Horizontal sync pulse width (pixels) (lower 8 bits)	40		width = 64 pixels = 40h
40	Vert sync offset; Vert sync pulse width (upper nibble = lines, lower 4 bits of vertical sync offset) (lower nibble = lines, lower 4 bits of vertical sync pulse width)	55		vert sync. offset = 5 lines vert. sync width = 5 lines
41	bits 7,6: upper 2 bits of Hor. sync. offset bits 5,4: upper 2 bits of Hor. sync pulse width bits 3,2: upper 2 bits of vert sync offset bits 1,0: upper 2 bits of vert. sync pulse width	00	00000000	
42	Horizontal Image Size (mm, lower 8 bits)	13		Hor. Image size = 531mm = 213h
43	Vertical Image Size (mm, lower 8 bits)	8E		Vert. Image Size = 398mm = 18Eh (4:3 in this case).
44	Horizontal and Vertical Image Size (upper nibble = upper 4 bits of horiz.) (lower nibble = upper 4 bits of vert.)	21		
45	Horizontal Border (pixels)	0		Shall be 0
46	Vertical Border (pixels)	0		Shall be 0
47	Flags (bit 7 = non-interlaced; bit 5,6 = normal display; bit 1, 2, 3,4 = sync description; bit 0 = don't care)	18	00011000	Flag = non-interlaced; non-stereo; digital separate; negative V sync; negative H sync

Table 72 Example EDID Detailed Timing Descriptor for 720x576p (50 Hz, 4:3)

Byte# (HEX)	Function	Value (HEX)	Value (binary)	Notes
36	Pixel Clock/10,000 (LSB stored first)	8C		Pixel Clock = 27.00MHz
37		0A		
38	Horizontal Active Pixels (lower 8 bits)	D0		hor. active pixels = 720 = 2D0h
39	Horizontal Blanking Pixels (lower 8 bits)	90		hor. blanking pixels = 144 = 90h
3A	Horizontal Active and Blanking Pixels (upper nibble = upper 4 bits of active) (lower nibble = upper 4 bits of blanking)	20		
3B	Vertical Active Lines, lower 8 bits	40		vert. active lines = 576 = 240h
3C	Vertical Blanking Lines, lower 8 bits	31		vert. blanking lines = 49 = 31h
3D	Vertical Active: Vertical Blanking (upper nibble = upper 4 bits of active) (lower nibble = upper 4 bits of blanking)	20		
3E	Horizontal sync. offset (pixels) (from blanking starts, lower 8 bits)	0C		offset = 12 pixels = 0Ch
3F	Horizontal sync pulse width (pixels) (lower 8 bits)	40		width = 64 pixels = 40h
40	Vert sync offset; Vert sync pulse width (upper nibble = lines, lower 4 bits of vertical sync offset) (lower nibble = lines, lower 4 bits of vertical sync pulse width)	55		vert sync. offset = 5 lines vert. sync width = 5 lines
41	bits 7,6: upper 2 bits of Hor. sync. offset bits 5,4: upper 2 bits of Hor. sync pulse width bits 3,2: upper 2 bits of vert sync offset bits 1,0: upper 2 bits of vert. sync pulse width	00	00000000	
42	Horizontal Image Size (mm, lower 8 bits)	C4		Hor. Image size = 708mm = 2C4h
43	Vertical Image Size (mm, lower 8 bits)	8E		Vert. Image Size = 398mm = 18Eh (16:9 in this case).
44	Horizontal and Vertical Image Size (upper nibble = upper 4 bits of horiz.) (lower nibble = upper 4 bits of vert.)	21		
45	Horizontal Border (pixels)	0		Shall be 0
46	Vertical Border (pixels)	0		Shall be 0
47	Flags (bit 7 = non-interlaced; bit 5,6 = normal display; bit 1, 2, 3,4 = sync description; bit 0 = don't care)	18	00011000	Flag = non-interlaced; non-stereo; digital separate; negative V sync; negative H sync

Table 73 Example EDID Detailed Timing Descriptor for 720x576p (50 Hz, 16:9)

Byte# (HEX)	Function	Value (HEX)	Value (binary)	Notes
36	Pixel Clock/10,000 (LSB stored first)	8C		Pixel Clock = 27.00MHz
37		0A		
38	Horizontal Active Pixels (lower 8 bits)	A0		hor. active pixels = 1440 = 5A0h
39	Horizontal Blanking Pixels (lower 8 bits)	20		hor. blanking pixels = 288 = 120h
3A	Horizontal Active and Blanking Pixels (upper nibble = upper 4 bits of active) (lower nibble = upper 4 bits of blanking)	51		
3B	Vertical Active Lines, lower 8 bits	20		vert. active lines = 288 = 120h
3C	Vertical Blanking Lines, lower 8 bits	18		vert. blanking lines = 24 = 18h
3D	Vertical Active: Vertical Blanking (upper nibble = upper 4 bits of active) (lower nibble = upper 4 bits of blanking)	10		
3E	Horizontal sync. offset (pixels) (from blanking starts, lower 8 bits)	18		offset = 24 pixels = 18h
3F	Horizontal sync pulse width (pixels) (lower 8 bits)	7E		width = 126 pixels = 7Ch
40	Vert sync offset; Vert sync pulse width (upper nibble = lines, lower 4 bits of vertical sync offset) (lower nibble = lines, lower 4 bits of vertical sync pulse width)	23		vert sync. offset = 2 lines vert. sync width = 3 lines
41	bits 7,6: upper 2 bits of Hor. sync. offset bits 5,4: upper 2 bits of Hor. sync pulse width bits 3,2: upper 2 bits of vert sync offset bits 1,0: upper 2 bits of vert. sync pulse width	00	00000000	
42	Horizontal Image Size (mm, lower 8 bits)	13		Hor. Image size = 531mm = 213h
43	Vertical Image Size (mm, lower 8 bits)	8E		Vert. Image Size = 398mm = 18Eh (4:3 in this case).
44	Horizontal and Vertical Image Size (upper nibble = upper 4 bits of horiz.) (lower nibble = upper 4 bits of vert.)	21		
45	Horizontal Border (pixels)	0		Shall be 0
46	Vertical Border (pixels)	0		Shall be 0
47	Flags (bit 7 = non-interlaced; bit 5,6 = normal display; bit 1, 2, 3,4 = sync description; bit 0 = don't care)	98	10011000	Flag = interlaced; non-stereo; digital separate; negative V sync; negative H sync

Table 74 Example EDID Detailed Timing Descriptor for 720x576i (50 Hz, 4:3)

Byte# (HEX)	Function	Value (HEX)	Value (binary)	Notes
36	Pixel Clock/10,000 (LSB stored first)	8C		Pixel Clock = 27.00MHz
37		0A		
38	Horizontal Active Pixels (lower 8 bits)	A0		hor. active pixels = 1440 = 5A0h
39	Horizontal Blanking Pixels (lower 8 bits)	20		hor. blanking pixels = 288 = 120h
3A	Horizontal Active and Blanking Pixels (upper nibble = upper 4 bits of active) (lower nibble = upper 4 bits of blanking)	51		
3B	Vertical Active Lines, lower 8 bits	20		vert. active lines = 288 = 120h
3C	Vertical Blanking Lines, lower 8 bits	18		vert. blanking lines = 24 = 18h
3D	Vertical Active: Vertical Blanking (upper nibble = upper 4 bits of active) (lower nibble = upper 4 bits of blanking)	10		
3E	Horizontal sync. offset (pixels) (from blanking starts, lower 8 bits)	18		offset = 24 pixels = 18h
3F	Horizontal sync pulse width (pixels) (lower 8 bits)	7E		width = 126 pixels = 7Eh
40	Vert sync offset; Vert sync pulse width (upper nibble = lines, lower 4 bits of vertical sync offset) (lower nibble = lines, lower 4 bits of vertical sync pulse width)	23		vert sync. offset = 2 lines vert. sync width = 3 lines
41	bits 7,6: upper 2 bits of Hor. sync. offset bits 5,4: upper 2 bits of Hor. sync pulse width bits 3,2: upper 2 bits of vert sync offset bits 1,0: upper 2 bits of vert. sync pulse width	00	00000000	
42	Horizontal Image Size (mm, lower 8 bits)	C4		Hor. Image size = 708mm = 2C4h
43	Vertical Image Size (mm, lower 8 bits)	8E		Vert. Image Size = 398mm = 18Eh (16:9 in this case).
44	Horizontal and Vertical Image Size (upper nibble = upper 4 bits of horiz.) (lower nibble = upper 4 bits of vert.)	21		
45	Horizontal Border (pixels)	0		Shall be 0
46	Vertical Border (pixels)	0		Shall be 0
47	Flags (bit 7 = non-interlaced; bit 5,6 = normal display; bit 1, 2, 3,4 = sync description; bit 0 = don't care)	98	10011000	Flag = interlaced; non-stereo; digital separate; negative V sync; negative H sync

Table 75 Example EDID Detailed Timing Descriptor for 720x576i (50 Hz, 16:9)



**Annex B Application to DVI 1.0 (Normative)**

All mandatory aspects of DVI 1.0 [2] shall be implemented with the exception of those expressly identified as optional or informative in that standard when DVI 1.0 is used to implement CEA-861-C. DVI does not support transport of CEA InfoFrames, audio or  $YC_B C_R$  pixel data. However, CEA-861-C can still be implemented on DVI 1.0 (with reduced functionality) as explained in Section 6.

All sections in Annex B are normative when DVI 1.0 is used to implement CEA-861-C except as otherwise noted.

**B.1 Connector and Cable**

The connector used shall be DVI-Digital, Single Link [2].

The cable, if supplied with the product, shall be compliant with the DVI specification at maximum pixel clock frequency compatible with the product.

**B.2 Digital Content Protection**

High -bandwidth Digital Content Protection (HDCP) [4] shall be available to authenticate display devices and encrypt content transmitted across the DVI interface.

**B.2.1 Additional Information**

**DVI 1.0:** [www.ddwg.org](http://www.ddwg.org)

**HDCP:** [www.digital-cp.com](http://www.digital-cp.com)

**Annex C Application to Open LDI (Normative)**

All mandatory aspects of OpenLDI 0.95 [7] shall be implemented with the exception of those expressly identified as optional or informative in that standard when OpenLDI 0.95 is used to implement CEA-861-C. It should be noted that at the time of this writing, a version of OpenLDI that supports transport of CEA InfoFrames was not available. However, CEA-861-C can still be implemented on OpenLDI 0.95 (with reduced functionality) as explained in Section 6.

All sections in this Annex are normative when OpenLDI 0.95 is used to implement CEA-861-C except as otherwise noted.

**C.1 Open LDI Data and Control Signals**

OpenLDI has two options for display synchronization:

- a) DC Balance Mode:
- b) Non DC Balance Mode:

In DC Balance mode synchronization is accomplished by transmitting control signals during the Display blanking intervals as shown in Figure 39.

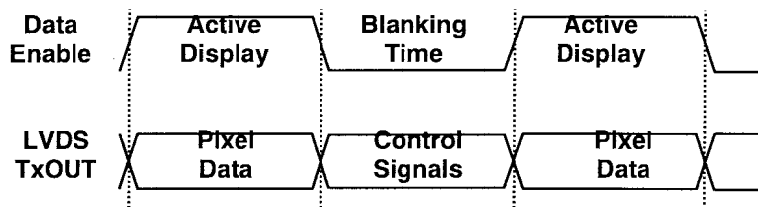

**Figure 39 OpenLDI Synchronization**

In the single or dual LVDS bus mode (24 or 48 bit Total), the control signals are transmitted over 7 transition words on specific output signals during the blanking period as indicated in Table 76.

Control Signal	Signal Level	Output Signal	Data Pattern
DE	High	CLK1 and CLK2	1111000 or 1110000
	Low		1111100 or 1100000
HSYNC	High	A0	1100000 or 1111100
	Low		1110000 or 1111000
VSYNC	High	A1	1100000 or 1111100
	Low		1110000 or 1111000

**Table 76 OpenLDI Control Signals**

**C.2 Non DC Balanced Mode**

Control signals are transmitted as part the LVDS serialized data stream. The controls signals are then de-serialized and regenerated at the receiver outputs to the EDTV/HDTV Monitor.

**C.3 OpenLDI Cabling Information**

An OpenLDI cable assembly shall consist of a cable meeting the requirements of this section with an OpenLDI plug on each end or an OpenLDI plug on one end and the other end permanently affixed to the display device. Acceptable cables for OpenLDI may use either shielded or unshielded twisted pairs. It is up to the manufacturer of the OpenLDI equipment to use the grade and type of cable required to meet applicable regulatory requirements. Adherence to CEA-861-C does not guarantee regulatory compliance.

When the OpenLDI is an interface internal to an assembly and not accessible externally, the OpenLDI cable may be replaced with any cable or connection means appropriate to the requirements of the assembly.

**C.3.1 Cable Length**

The maximum cable length shall be 10m.

**C.3.2 Number of Signal Conductors**

The OpenLDI cable shall comprise 11 twisted pairs and 10 individual conductors.

**C.3.3 Wire Gauge**

Each conductor in an OpenLDI cable shall be no less than 28AWG.

**C.3.4 Conductor Resistance**

The resistance of a single conductor of an OpenLDI cable shall not exceed  $4\Omega$  when the conductor is of the maximum length specified in CEA-861-C.

**C.3.5 Insulation**

Each conductor in the cable shall be separately insulated. The minimum insulation resistance shall be  $1G\Omega$ .

**C.3.6 Shield Requirement**

The OpenLDI cable shall be encompassed by a single shield, surrounding all conductors in the cable. The shield shall provide a minimum of 90% coverage.

For shielded twisted pair cable, each twisted pair shall be shielded individually. Each shield shall provide a minimum of 90% coverage.

**C.3.7 Single Twisted Pair Transmission Skew**

The differential time of transmission (single pair transmission skew) of a pulse through a single differential pair in an OpenLDI cable shall not exceed 300ps.

**C.3.8 Multiple Twisted Pair Transmission Skew**

The differential time of transmission (pair to pair transmission skew) of a pulse through any two differential pairs in an OpenLDI cable shall not exceed 1 bit time.

**C.3.9 USB Cable Requirements**

The conductors used for transmission of USB signals on the OpenLDI cable shall meet the requirements stated in the Universal Serial Bus Specification, Version 1.0, January 15, 1996.

**C.3.10 DDC Cable Requirements**

The conductors used for transmission of DDC signals on the OpenLDI cable shall meet the requirements stated in the VESA Display Data Channel Command Interface (DDC/CI) Standard, Version 1, August 14, 1998 [33].

More information on the connector is available in Section 7.2 of the OpenLDI specification [7].

**OpenLDI .95 website Location:**

<http://www.National.com/appinfo/fpd>

## **Annex D Application to HDMI (Informative)**

### **D.1 InfoPackets**

HDMI carries each InfoFrame in its own HDMI packet. The HDMI packet type for an InfoFrame packet is equal to 0x80+InfoFrame Type, therefore, only InfoFrames with Types less than 0x80 may be transmitted. Including Type, Version and Length fields, InfoFrames of at most 30 bytes are supported. A checksum is present in each InfoFrame.

Refer to the HDMI Specification for more detail on the packetization of InfoFrames.

### **D.2 EDID**

A DTV monitor using an HDMI input shall contain an EDID consisting of a single E-EDID version 1.3 (or newer) block and at least one CEA Extension version 3.

A DTV monitor that supports either type of YC<sub>b</sub>C<sub>r</sub> pixel data (4:2:2 or 4:4:4) shall support both types and therefore shall set both bits 4 and 5 of byte 3 of all CEA EDID Extensions within the EDID. A DTV monitor that does not support YC<sub>b</sub>C<sub>r</sub> pixel data shall have both bits 4 and 5 clear. See D.6 for an example.

### **D.3 Audio**

HDMI is capable of carrying uncompressed digital audio (PCM), in an IEC-60958-compliant stream at up to 8 channels, up to 192kHz and up to 24 bits/sample, or, compressed digital audio, in an IEC-61937-compliant stream, up to a frame rate of 192kHz.

HDMI relies on the defined audio discovery mechanisms present in the CEA EDID Extension version 3.

The Audio InfoFrame, the IEC-60958 "Channel Status" bits, and the IEC61937 "Burst Info" bits are used to describe the transmitted audio stream. The Audio InfoFrame CT (coding type), SS (sample size) and SF (sample frequency) fields are required to be 0 ("Refer to Stream Header") to avoid redundancy with the same data already contained within the IEC-60958 stream data.

### **D.4 HDCP**

High-bandwidth Digital Content Protection (HDCP) version 1.1 or later, is available to protect the audio and video data carried on an HDMI link.

### **D.5 Additional Information**

HDMI information is available from HDMI Licensing, LLC at [www.hdmi.org](http://www.hdmi.org).

HDCP information is available from Digital-CP, LLC at [www.digital-cp.com](http://www.digital-cp.com).

### **D.6 Example EDID Using Elements of CEA Block Tag Extension (Applicable to HDMI)**

Table 82 contains an example implementation of EDID utilizing elements of the CEA Block Tag Extension that were not addressed in Annex A. These elements are Short Video Descriptors, Audio Descriptors, Speaker Allocation Block, and a Vendor-Specific Data Block. This example is applicable to HDMI implementations. Elements of the Example EDID are addressed individually, in the following subsections.

#### **D.6.1 First Monitor Descriptor (Monitor Name) and Second Monitor Descriptor (Monitor Range Limits)**

Although Annex A requires that two of the four 18-byte detailed timing descriptors be a Monitor Name Descriptor and a Monitor Descriptor, it is possible that implementations designed for Personal Computers (e.g., multimedia applications), may contain a different set of data. For that reason, source devices adhering to CEA-861-C should be designed without dependency upon specific data within these blocks that prevent collection and interpretation of subsequent data blocks.

#### **D.6.2 Extension Flag and Checksum**

The Extension Flag and Checksum are defined the same as in Annex A.

#### **D.6.3 CEA Extension Header (Block 1)**

The CEA Extension Header is a four-data bytes located in address range 80h through 83h. The first byte is the tag used to identify the extension. The number assigned by VESA to this tag is 02h. Following the CEA Extension Tag is the Revision Number location. In this example the Revision Number is set to 03h

as required by CEA-861-C. Please note that all Revision numbers are backward compatible. Source devices should not have a dependency upon Revision Numbers.

Table 77 contains data based upon the tables presented in this Annex. In this example, the CEA Extension Tag is located at address 80h followed by Revision Number, Byte Number Offset, and Reserved (i.e., 00h). The data is set as prescribed by CEA-861-C.

Address Hex	Example Data		Name of Block	Description	Remarks
	Hex	Dec			
80	02	2	CEA Extension Header	Tag	Block One
81	03	3		03h (reserved in CEA-861-B)	Revision Number (Start of CEA Block Tag Extension)
82	1A				Byte Offset
83	71	113		Global Declarations	DTV, YCbCr (4:4:4), YCbCr (4:2:2)

**Table 77 CEA Extension Header (Block 1)**

#### D.6.4 CEA Data Block Collection

The CEA Data Block Collection is within the CEA Extension Block and declares CEA Short Video Descriptors, Audio capabilities, Speaker configuration, a Vendor Specific Block that requires an Identifier code, and a Vendor Specific Payload block that is used to carry additional and optional data. As noted in Section 7.5, the Data Block ordering sequence is not constrained and various combinations are possible; and therefore, the examples provided herein are based upon one possible combination.

#### D.6.5 Video Data Block

The purpose of this block is for listing Short Video Descriptors (SVDs). Short Video Descriptors are used to declare video formats with one byte as contrasted with 18 bytes for Detailed Timing Descriptors, which is useful in economizing memory space. The video format the display looks best is should be placed in the first location. Additional video formats are placed in subsequent locations. Video formats should be listed in hierarchal priority.

As defined in Table 29 (General Tag Format), the first byte is used to signify a Video Tag Code and Payload Length. Bits 5 to 7 designate the Tag Code and payload length is defined by bits 0 to 4.

The payload byte structure is defined in Table 33. Bits 0 through 6 are used for Video Identification Codes as defined in Table 3, Video Format Timings; and bit 7 (MSB) is a marker bit called "Native." If bit 7 is set to '1' the meaning is "Native format" and if set to 'zero' the format is not "Native." Often, the video format the display looks best is the "Native" format. The "Native" bit should be set for only one video format.

In the example, as shown in Table 78, bits 5 through 7 located in address 84h are set to Tag Code 2 (04h) designating a Video Data Block; and bits 0 to 4 is set to 7h indicating seven bytes of data payload. Addresses 85h through 8Bh contain one discrete Short Video Descriptor code per byte.

Address Hex	Example Data		Name of Block	Description	Remarks
	Hex	Dec			
84	47		<b>Video Data Block</b>	Start of data block collection. Includes Tag Code and length of following data block payload	47h = Video Block (code = 2) and seven bytes of data payload
85	85			1 <sup>st</sup> Short Video Descriptor	1920 x 1080i @ 59.94/60 Hz 16:9 Native Mode
86	02			2 <sup>nd</sup> Short Video Descriptor	720 x 480p 59.94/60 Hz 4:3
87	03			3 <sup>rd</sup> Short Video Descriptor	720 x 480p 59.94/60 Hz 16:9
88	04			4 <sup>th</sup> Short Video Descriptor	1280 x 720p 59.94/60 Hz 16:9
89	06			5 <sup>th</sup> Short Video Descriptor	720 (1440) x 480i 59.94/60 Hz 4:3
8A	07			6 <sup>th</sup> Short Video Descriptor	720 (1440) x 480i 59.94/60 Hz 4:3
8B	01			7 <sup>th</sup> Short Video Descriptor	640 x 480p 59.94/60 Hz 4:3

Table 78 Video Data Block

### D.6.6 CEA Audio Block

The Audio Data Block is used to declare format, frequency and bit-rate. The structure of this table is defined in Section 7.5.2 with subsequent tables addressing the General Tag Format, Short Audio Descriptors, and Audio Format Codes. Multiple, Short Audio Descriptors may be used in this block.

The first byte in this block is the General Format Tag and is the same structure as the Video Data Block as defined in Table 27, General Tag Format. The Tag Code occupies bits 5 and 7; and Payload Length is placed in bits 0 through 4. Audio Tag Codes are listed in Table 34, Audio Format Codes. Three bytes of data are used for each Short Audio Descriptor.

Short Audio Descriptors are defined in Tables 33, 34, and 35; with Table 33 dealing with Linear PCM Audio and compressed audio formats in the remaining tables. Each Descriptor consists of three data bytes.

In Table 79, as with the Video Data Block, the first byte (8Ch) is used to indicate block type and payload length in bytes. Audio Tag Code 1 (02h) is placed in bits 3 and 7; and bits 0 to 4 contains 3h for a payload of three bytes. The Short Audio Descriptor begins at address 8Dh and ends with 8Fh. In the first byte of the descriptor, bit 7 is reserved and set to 'zero'. Bits 3 through 6 contain the Audio Format code as defined in Table 34; in this example Code 1 for Linear PCM is indicated with bit 3 set to '1'. Bits 0 through 2 designate the maximum number of channels as one channel audio (1h). The second descriptor byte uses seven bits to declare frequency characteristics. Frequencies of 32 kHz, 44.1 kHz, and 48 kHz are indicated by the 07h as defined by Table 31. In address 8Eh; and in the next address 07h is used to declare bit-rates of 16, 20 and 24 bit audio per Table 33. This example does not illustrate Short Audio Descriptors for compressed audio formats.

Address Hex	Example Data		Name of Block	Description	Remarks
	Hex	Dec			
8C	23		Audio Data Block	Start of Audio Block	23h = Audio Block (code = 1) and three bytes of data payload.
8D	09			Audio Format	Code 1 = Linear PCM (IEC60985)
8E	07			Frequency	07h = 32 kHz, 44.1 kHz, 48 kHz
8F	07			Bit Rate	07h = 16 bit, 20 bit, 24 bit

Table 79 Audio Data Block

### D.6.7 Speaker Allocation Block

The Speaker Allocation Data Block is used to declare number of speakers and configuration. As with preceding blocks a Tag Code and payload length are designated in the first data byte. The second byte is

the first byte of the data block payload and consists of seven bits and one reserved bit. These are used to indicate speaker count and configuration. The remaining two data payload bytes are set to zero (see Table 37).

In Table 80, address 90h contains a value 83h which designates the beginning of the Speaker Allocation Block and data payload. In this example, the Speaker Allocation Data Block is indicated by Code 4 per Table 29. The data payload is set to three bytes. At address 91 FL/FR (2 Channel Stereo) is chosen by setting the bits to 01h. The two remaining addresses have the bits set to zero as required by Table 37.

Address Hex	Example Data		Name of Block	Description	Remarks
	Hex	Dec			
90	83		Speaker Allocation Block	Start of Speaker Allocation	83h = Speaker Allocation Data Block (code = 4) and three bytes of data payload.
91	01			Speaker Designation	01 = FL / FR (2 Channel Stereo.)
92	00			Reserved	Always zero
93	00			Reserved	Always zero

**Table 80 Speaker Data Block**

#### D.6.8 Vendor Specific Block

The Vendor Specific Data Block was originally intended as an option to place data not specified by CEA-861-C; data that a manufacturer may care to use. However, the HDMI specification makes requirements that are addressed below. Users are advised to treat this data block with care.

The first address requires a Tag Code and data payload length in the first byte. The next two addressed house a 24-bit IEEE Registration Identifier (two bytes); and a Vendor Specific Payload in the remaining bytes. In the case of HDMI compliant devices the IEEE Registration is used as an 'HDMI Identifier.' After the HDMI Identifier two bytes are used to identify the port configuration. Users are advised to refer to the HDMI specification for details. For the purposes of this example the HDMI Identifier and Physical Source Address are presented.

As shown in Table 81, the first address, 94h, the Tag Code is listed as '3' and the payload length is set to '5' bytes. The second, third and fourth bytes, addresses 95, 96 and 97h, contain the HDMI LLC's 24-bit IEEE registration Organizationally Unique Identifier (OUI) 030Ch, which is coded least significant byte first. The Physical Source Address is found in address 98 and 99h and according to the HDMI specification, the two bytes are used as Identity Port Configuration with 1000h indicating a single port sink device. The last byte in the data payload or Vendor Specific Payload address is set to zero.

Address Hex	Example Data		Name of Block	Description	Remarks
	Hex	Dec			
94	65		Vendor Specific Data Block	Start of Vendor Specific Block	65h = Vendor Specific Block (code = 3) and five bytes of data payload.
95	03			24-bit IEEE Registration	HDMI Identifier = 000C03h (The big-endian HDMI-LLC's 24-bit OUI Registration Identifier 0x000C03 is placed into the EDID in little-endian order.)
96	0C				
97	00				
98	10			Components of Source Physical Address	Sink identifies location of source in signal path relative to root display as ABCDh. Example shows input '1' of root display (A=1, B=0, C=0, D=0 or 1000h).
99	00				

**Table 81 Vendor Specific Data Block**

**D.6.9 Complete CEA-861-C Example with Block Tag Extension**

Table 82 contains an example implementation of E-EDID utilizing elements of the CEA Block Tag Extension that were not addressed in Annex A. These elements are Short Video Descriptors, Audio Descriptors, Speaker Allocation Block, and a Vendor-Specific Data Block. This example is applicable to HDMI implementations.

Address Hex	Example Data		Name of Block	Description	Remarks
	Hex	Dec			
00	00	0	<b>Block Zero Header</b>		Fixed Value
01	FF	255			
02	FF	255			
03	FF	255			
04	FF	255			
05	FF	255			
06	FF	255			
07	00	0			
08	0C	12	<b>Vendor / Product ID</b>	Manufacturer Name	CEA
09	A1	161		Product Code	Used to differentiate between different models from the same manufacturer.
0A	00	0		Serial Number	Optional. The serial number can also be stored in a separate descriptor block
0B	00	0			
0C	00	0		Week of Manufacture	Optional. If this field is unused, the value should be set to 0.
0D	00	0			
0E	00	0		Year of Manufacture	Year 2005
0F	00	0			
10	00	0			
11	0F	15	<b>EDID Structure Version / Revision</b>	Version #	1
12	01	1		Revision #	3
13	03	3	<b>Basic Display Parameters / Features</b>	Video Input Definition	Digital, VESA DFP1X : not compatible
14	80	128		Max. Horizontal Image Size in cm	Optional. The system should not make any assumption regarding display size
15	50	80		Max. Vertical Image Size in cm	Optional. See above.
16	2D	45		Gamma: (gamma x 100)-100 = value	Example is: (gamma = 2.2) (2.2 x 100)-100 = 120
17	78	120		Feature Support	0x0A denotes: RGB color Display type, preferred timing: first detailed timing block. GTF timing: not supported. Standby mode: not supported, suspend mode: not supported, active off: not supported
18	0A	10			
19	0D	13	<b>Color Characteristics</b>	Red/Green Low Bits	
1A	C9	201		Blue/White Low Bits	
1B	A0	160		Red-x	0.625
1C	57	87		Red-y	0.340
1D	47	71		Green-x	0.280
1E	98	152		Green-y	0.595
1F	27	39		Blue-x	0.155
20	12	18		Blue-y	0.070



Address Hex	Example Data		Name of Block	Description	Remarks
	Hex	Dec			
21	48	72	<b>Established Timings</b>	White-x	0.283
22	4C	76		White-y	0.298
23	20	32		Timing 1	640x480 @ 60Hz
24	00	0		Timing 2	None
25	00	0		Manufacturer's Reserved Timing	None
26	01	1	<b>Standard Timing ID # 1-8</b>	Standard Timing ID #1	PC Application
27	01	1		Standard Timing ID #2	PC Application
28	01	1		Standard Timing ID #3	PC Application
29	01	1		Standard Timing ID #4	PC Application
2A	01	1		Standard Timing ID #5	PC Application
2B	01	1		Standard Timing ID #6	PC Application
2C	01	1		Standard Timing ID #7	PC Application
2D	01	1		Standard Timing ID #8	PC Application
2E	01	1			
2F	01	1			
30	01	1			
31	01	1			
32	01	1			
33	01	1			
34	01	1			
35	01	1			
36	01	1	<b>First Detailed Timing Descriptor (Preferred)</b>	Pixel Clock	74.25MHz
37	1D	29		H Active	1920 pixels
38	80	128		H Blanking	280 pixels
39	18	24		H Active: H Blanking	
3A	71	113		V Active	540 lines
3B	1C	28		V Blanking	22 lines
3C	16	22		V Active: V Blanking	
3D	20	32		H Sync Offset	88 pixels
3E	58	88		H Sync Pulse Width	44 pixels
3F	2C	44		VS Offset: VS Pulse Width	2 lines, 5 lines
40	25	37		HS Offset: HS Pulse Width: VS Offset: VS Pulse Width	
41	00	0		H Image Size	800 mm (lower 8 bits)
42	20	32		V Image Size	450mm (lower 8 bits)
43	C2	194	H&V Image Size	Upper 4 bits of H & V size	
44	31	49	H Border	0 lines	
45	00	0	V Border	0 pixels	
46	00	0	Flags	Interlaced, normal display no stereo, digital separate, V- sync polarity is positive, H- sync polarity is positive	
47	9E	158			
48	8C	140	<b>Second Detailed Timing Descriptor (Next Preferred)</b>	Pixel Clock	27MHz
49	0A	10		H Active	720 pixels
4A	D0	208		H Blanking	138 pixels
4B	8A	138		H Active: H Blanking	
4C	20	32		V Active	480 lines
4D	E0	224		V Blanking	45 lines
4E	2D	45			

Address Hex	Example Data		Name of Block	Description	Remarks	
	Hex	Dec				
4F	10	16		V Active: V Blanking		
50	10	16		H Sync Offset	16 pixels	
51	3E	62		H Sync Pulse Width	62 pixels	
52	96	150		VS Offset: VS Pulse Width	9 lines, 6 lines	
53	00	0		HS Offset: HS Pulse Width: VS Offset: VS Pulse Width		
54	58	88		H Image Size	600mm (lower 8 bits)	
55	C2	194		V Image Size	450 mm (lower 8 bits)	
56	21	33		H&V Image Size	Upper 4 bits of H & V size	
57	00	0		H Border	0 lines	
58	00	0		V Border	0 pixels	
59	18	24		Flags	non interlaced, normal display no stereo, digital separate, V. and H. sync polarity is negative	
5A	00	0		<b>Monitor Descriptor</b> (Currently Mandatory (Monitor Name) Mandatory)	Flag	
5B	00	0			Flag (Reserved)	
5C	00	0			Data Type Tag	Monitor name type
5D	FC	252	Flag			
5E	00	0	M			
5F	4D	77	Y			
60	59	89				
61	20	32				
62	48	72	H			
63	44	68	D			
64	54	84	T			
65	56	86	V			
66	0A	10				
67	20	32				
68	20	32				
69	20	32				
6A	20	32				
6B	20	32				
6C	00	0	<b>Second Monitor Descriptor</b> Currently Mandatory Mandatory (range limits, binary coded)	Flag		
6D	00	0		Flag (Reserved)		
6E	00	0		Data Type Tag	Monitor Range limits, binary coded, mandatory block	
6F	FD	253		Flag		
70	00	0		Min Vertical Rate in Hz	59 HZ	
71	3B	59		Max Vertical Rate in Hz	61 Hz	
72	3D	61		Min Horizontal Rate in kHz	15KHz	
73	0F	15		Max Horizontal Rate in kHz	46KHz	
74	2E	46		Max Supported pixel clock rate in MHz/10	80MHz	
75	08	8		Tag for secondary timing formula, GTF (00h=not used)	No secondary timing formula supported	
76	00	0		Fixed		
77	0A	10		Fixed		
78	20	32	Fixed			

Address Hex	Example Data		Name of Block	Description	Remarks
	Hex	Dec			
79	20	32		Fixed	
7A	20	32		Fixed	
7B	20	32		Fixed	
7C	20	32		Fixed	
7D	20	32		Fixed	
7E	01	1	<b>Extension Flag</b>	Number of 128 bytes blocks to follow	
7F	C0	192	<b>Checksum</b>	Checksum	Block 0 sum = FFh&(100h-(1B40h&FFh) = C0h
80	02	2	<b>CEA Extension Header</b>	Tag	Block One
81	03	3		05h 03h (reserved in CEA-861-B)	Revision Number (Start of VESA CEA Block Tag Extension)
82	1A	26		04h, no data in Reserved	Byte Offset
83	71	113		Global Declarations	Content depends on implementation DTV, YCbCr (4:4:4), YCbCr (4:2:2)
84	47	71	<b>CEA Data Block Collection Video Data Block</b>	Start of data block collection. Includes Tag Code and length of following data block payload	47h = Video Block (code = 2) and seven bytes of data payload
85	85	133		1 <sup>st</sup> Short Video Descriptor	1920 x 1080i @ 59.94/60 Hz 16:9 Native Mode
86	02	2		2 <sup>nd</sup> Short Video Descriptor	720 x 480p 59.94/60 Hz 4:3
87	03	3		3 <sup>rd</sup> Short Video Descriptor	720 x 480p 59.94/60 Hz 16:9
88	04	4		4 <sup>th</sup> Short Video Descriptor	1280 x 720p 59.94/60 Hz 16:9
89	06	6		5 <sup>th</sup> Short Video Descriptor	720 (1440) x 480i 59.94/60 Hz 4:3
8A	07	7		6 <sup>th</sup> Short Video Descriptor	720 (1440) x 480i 59.94/60 Hz 4:3
8B	01	1		7 <sup>th</sup> Short Video Descriptor	640 x 480p 59.94/60 Hz 4:3
8C	23	35	<b>Audio Data Block</b>	Start of Audio Block	23h = Audio Block (code = 1) and three bytes of data payload.
8D	09	9		Audio Format	Code 1 = Linear PCM (IEC60985)
8E	07	7		Frequency	07h = 32 kHz, 44.1 kHz, 48 kHz
8F	07	7		Bit Rate	07h = 16 bit, 20 bit, 24 bit
90	83	131	<b>Speaker Allocation Block</b>	Start of Speaker Allocation	83h = Speaker Allocation Data Block (code = 4) and three bytes of data payload.
91	01	1		Speaker Designation	01 = FL / FR (2 Channel Stereo.)
92	00	0		Reserved	Always zero
93	00	0		Reserved	Always zero
94	65	101	<b>Vendor Specific Data Block</b>	Start of Vendor Specific Block	65h = Vendor Specific Block (code = 3) and five bytes of data payload.
95	03	3		24-bit IEEE Registration	HDMI Identifier = 000C03h (The big-endian HDMI-LLC's
96	0C	12			

CEA-861-C

Address Hex	Example Data		Name of Block	Description	Remarks	
	Hex	Dec				
97	00	0			24-bit OUI Registration Identifier 0x000C03 is placed into the EDID in little-endian order.)	
98	10	16		Components of Source Physical Address		Sink identifies location of source in signal path relative to root display as ABCDh. Example shows input '1' of root display (A=1, B=0, C=0, D=0 or 1000h).
99	00	0				
9A	01	1	Third Detailed Timing Descriptor	Pixel Clock	74.25MHz	
9B	1D	29				
9C	00	0		H Active	1280 pixels	
9D	72	114		H Blanking	370 pixels	
9E	51	81		H Active: H Blanking		
9F	D0	208		V Active	720 lines	
A0	1E	30		V Blanking	30 lines	
A1	20	32		V Active: V Blanking		
A2	6E	110		H Sync Offset	110 pixels	
A3	28	40		H Sync Pulse Width	40 pixels	
A4	55	85		VS Offset: VS Pulse Width	Sync Offset = 5 lines, Sync width = 5 lines	
A5	00	0		HS Offset: HS Pulse Width: VS Offset: VS Pulse Width		
A6	20	32		H Image Size	800mm (lower 8 bits)	
A7	C2	194		V Image Size	450mm (lower 8 bits)	
A8	31	49		H&V Image Size	Upper 4 bits of H & V size	
A9	00	0		H Border	0 pixels	
AA	00	0	V Border	0 lines		
AB	1E	30	Flags	Non-interlaced, normal display no stereo, digital separate, H and V sync polarity is positive		
AC	8C	140	Fourth Detailed Timing Descriptor	Pixel Clock	27MHz	
AD	0A	10				
AE	A0	160		H Active	1440 pixels	
AF	14	20		H Blanking	276 pixels	
B0	51	81		H Active: H Blanking		
B1	F0	240		V Active	240 lines	
B2	16	22		V Blanking	22 lines	
B3	00	0		V Active: V Blanking		
B4	26	38		H Sync Offset	38 pixels	
B5	7C	124		H Sync Pulse Width	124 pixels	
B6	43	67		VS Offset: VS Pulse Width	Sync Offset = 4 lines, Sync width = 3 lines	
B7	00	0		HS Offset: HS Pulse Width: VS Offset: VS Pulse Width		
B8	58	88		H Image Size	600mm (lower 8 bits)	
B9	C2	194		V Image Size	450mm (lower 8 bits)	
BA	21	33		H&V Image Size	Upper 4 bits of H & V size	
BB	00	0		H Border	0 lines	
BC	00	0	V Border	0 pixels		
BD	98	152	Flags	interlaced, normal display no		

Address Hex	Example Data		Name of Block	Description	Remarks
	Hex	Dec			
					stereo, digital separate, V. and H. sync polarity is negative,
BE	8C	140	Fifth Detailed Timing Descriptor	Pixel Clock	27MHz
BF	0A	10			
C0	D0	208		H Active	720 pixels
C1	8A	138		H Blanking	138 pixels
C2	20	32		H Active: H Blanking	
C3	E0	224		V Active	480 lines
C4	2D	45		V Blanking	45 lines
C5	10	16		V Active: V Blanking	
C6	10	16		H Sync Offset	16 pixels
C7	3E	62		H Sync Pulse Width	64 pixels
C8	96	150		VS Offset: VS Pulse Width	Sync Offset= 9 lines, Sync width = 6
C9	00	0		HS Offset: HS Pulse Width: VS Offset: VS Pulse Width	
CA	20	32		H Image Size	800mm (lower 8 bits)
CB	C2	194		V Image Size	450mm (lower 8 bits)
CC	31	49		H&V Image Size	Upper 4 bits of H&V size
CD	00	0		H Border	0 lines
CE	00	0		V Border	0 pixels
CF	18	24	Flags	interlaced, normal display no stereo, digital separate, V. and H. sync polarity is negative,	
D0	8C	140	Sixth Detailed Timing Descriptor	Pixel Clock	27MHz
D1	0A	10			
D2	A0	160		H Active	1440 pixels
D3	14	20		H Blanking	276 pixels
D4	51	81		H Active: H Blanking	
D5	F0	240		V Active	240 lines
D6	16	22		V Blanking	22 lines
D7	00	0		V Active: V Blanking	
D8	26	38		H Sync Offset	38 pixels
D9	7C	124		H Sync Pulse Width	124 pixels
DA	43	67		VS Offset: VS Pulse Width	Sync Offset = 4 lines, Sync Width = 3 lines
DB	00	0		HS Offset: HS Pulse Width: VS Offset: VS Pulse Width	
DC	20	32		H Image Size	800mm (lower 8 bits)
DD	C2	194		V Image Size	450mm (lower 8 bits)
DE	31	49		H&V Image Size	Upper 4 bits of H & V size
DF	00	0		H Border	0 lines
E0	00	0		V Border	0 pixels
E1	98	152	Flags	interlaced, normal display no stereo, digital separate, V. and H. sync polarity is negative,	
E2	00	0			
E3	00	0			
E4	00	0			

CEA-861-C

Address Hex	Example Data		Name of Block	Description	Remarks
	Hex	Dec			
E5	00	0			
E6	00	0			
E7	00	0			
E8	00	0			
E9	00	0			
EA	00	0			
EB	00	0			
EC	00	0			
ED	00	0			
EE	00	0			
EF	00	0			
F0	00	0			
F1	00	0			
F2	00	0			
F3	00	0			
F4	00	0			
F5	00	0			
F6	00	0			
F7	00	0			
F8	00	0			
F9	00	0			
FA	00	0			
FB	00	0			
FC	00	0			
FD	00	0			
FE	00	0			
FF	7A	122	<b>Checksum</b>		Block 1 sum = FFh+(100h-(1686h&FFh)) = 7Ah

Table 82 CEA-861-C EDID Example with Block Tag Extension

**Annex E [Reserved for Future Use]**

**Annex F Format Conversion Examples (Informative)**

In the example shown below in Figure 40, the DTV Monitor indicates by its EDID data that it can accept 1080i, 720p, 480i, or 480p. In the cases labeled (a), the conversion from the source material to 1080i is happening in the source box. In the other case, labeled (b), the source does no format conversion and delivers the as-decoded format across the interface. Conversion to 1080i is happening in the Display. If the Display indicates it has a single 1080i native format, it may not matter where the conversion takes place. If the Display is multi-scan and indicates the other formats are supported natively also, the best image presentation will probably result if the conversion takes place in the Display.

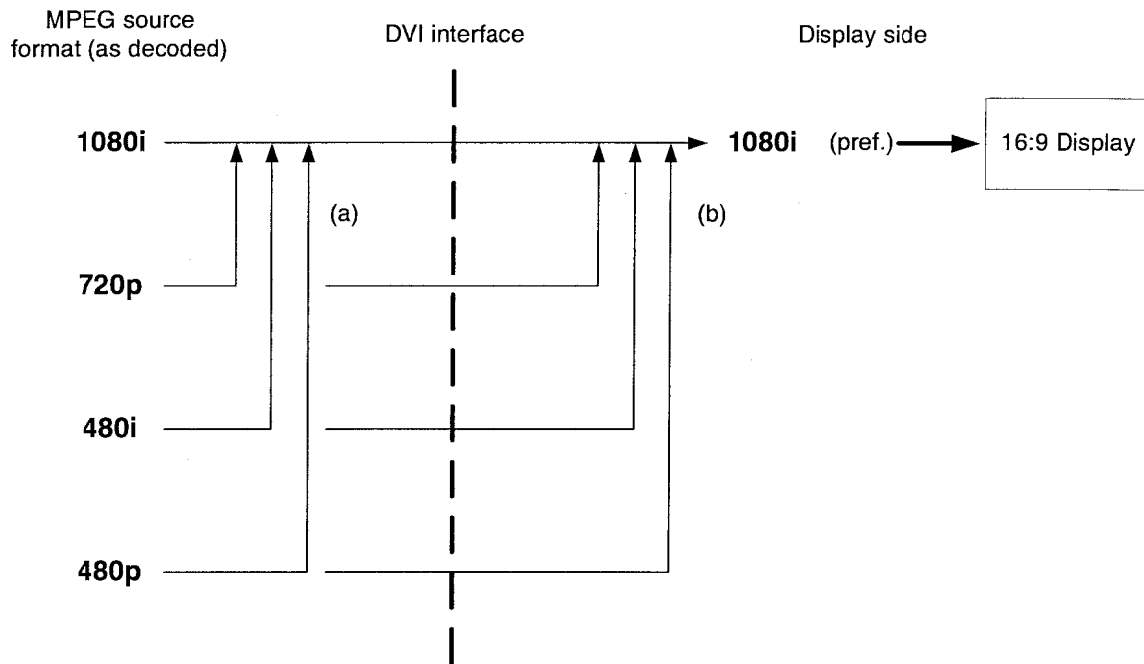

**Figure 40 Example of Options for Format Conversion**

In the example in Figure 41, the DTV Monitor can once again support 1080i, 720p, 480i, or 480p. In this case, the display is a 1024 by 576 LCD panel so none of these formats is native (although 720p is indicated as being "preferred"). The illustration shows conversions either taking place in the source device, in the Display, or in both. Any conversion performed in the source box is to 720p because 720p is indicated as the preferred format. This is a situation where at least one conversion takes place. In general, format conversions introduce errors and display artifacts. In the optimum system, at most one format conversion should be done between the MPEG-2 decoder and visual presentation.

In Figure 41, MPEG-2 video in 1080i format is decoded, and can be converted (c) into the display's preferred 720p format. In this case, the Display re-converts 720p into its native 1024 x 576 LCD format. Alternatively, the 1080i video can be delivered un-converted across the interface (d) where the Display performs one conversion to its native format. The cases marked (e) are similar, in that two conversions result if the source re-formats into 720p before delivering the data across the interface, but just one conversion results if the video is delivered in the same format as it was decoded. These cases illustrate that the best visual presentation may result when the source device transports (passes through) the video to the Display in the same basic format as the decoded MPEG2 stream (assuming the ultimate source is MPEG2).



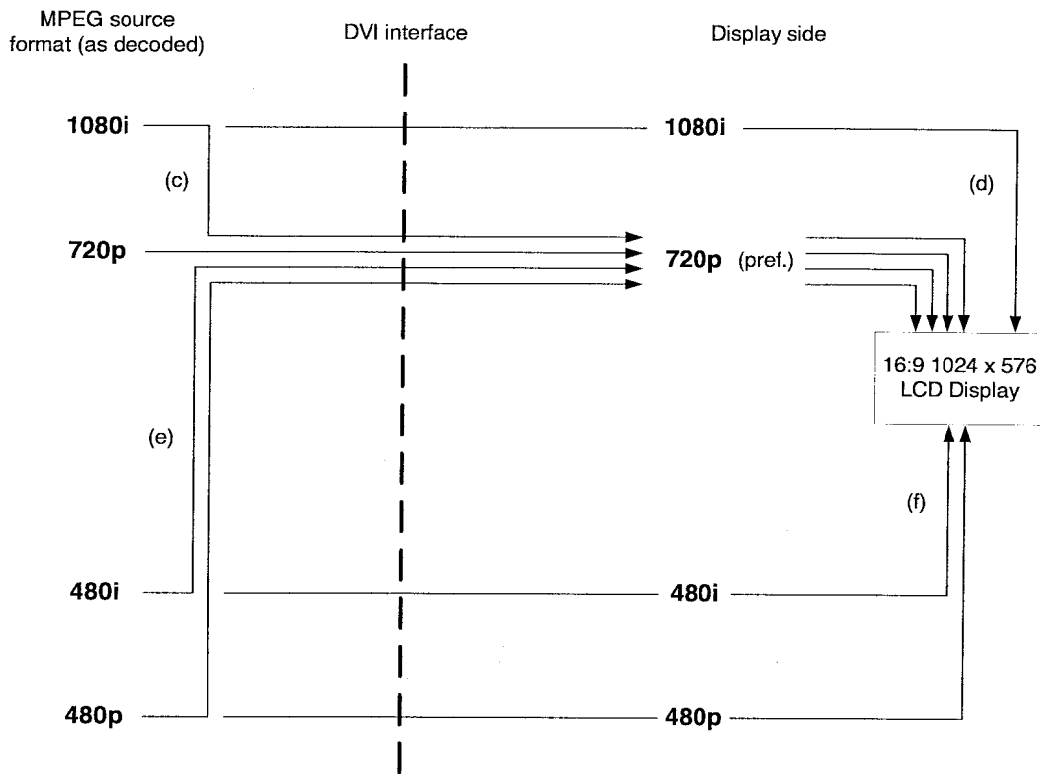

Figure 41 Multiple Conversions Example

**Annex G InfoPacket Framework (Informative)**

Previous versions of CEA-861-C defined an InfoPacket data structure that could be used to bundle one or more InfoFrames together for transmission across an existing digital interface. The InfoPacket mechanism is not used in any current interface and is not expected to be used in any future interface and so has been deprecated.

### Annex H DVB Active Format Description (Informative)

Annex H is extracted from Annex B of the DVB Guidelines document [3].

Figure 42 illustrates the meanings of the bounding rectangles, gray areas, and white circles as used in Table 83.

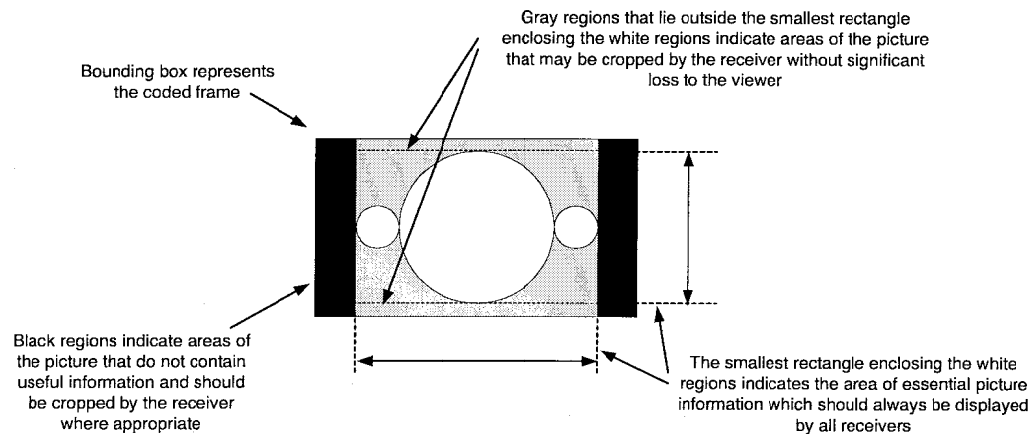

**Figure 42 Active Format Illustration**

#### Definitions:

<b>Coded Frame</b>	A picture within a compressed video stream such as MPEG2 that is coded as a single frame or as two fields.
<b>Coded Frame Aspect Ratio</b>	The picture aspect ratio associated with the coded frame of a compressed video stream such as MPEG2. It is either 4:3 or 16:9.

active_format		illustration of described format	
value	description	in 4:3 coded frame	in 16:9 coded frame
0000 - 0001	reserved		
0010	box 16:9 (top)		
0011	box 14:9 (top)		
0100	box > 16:9 (center)		
0101 - 0111	reserved		
1000	As the coded frame		
1001	4:3 (center)		<sup>18</sup>
1010	16:9 (center)		
1011	14:9 (center)		
1100	reserved		
1101	4:3 (with shoot & protect 14:9 center)		<sup>18</sup>
1110	16:9 (with shoot & protect 14:9 center)		
1111	16:9 (with shoot & protect 4:3 center)		

<sup>18</sup> It is recommended to use the 4:3 coded frame mode to transmit 4:3 source material rather than using a pillar box to transmit it in a 16:9 coded frame. This allows for higher horizontal resolution on both 4:3 and 16:9 sets.

Table 83 AFD Coding

**Annex I Picture Aspect Ratio Conversion Example (Informative)**

Figure 43 illustrates a possible problem if both the source and DTV Monitor stretch the video horizontally to fit into a picture with a larger aspect ratio.

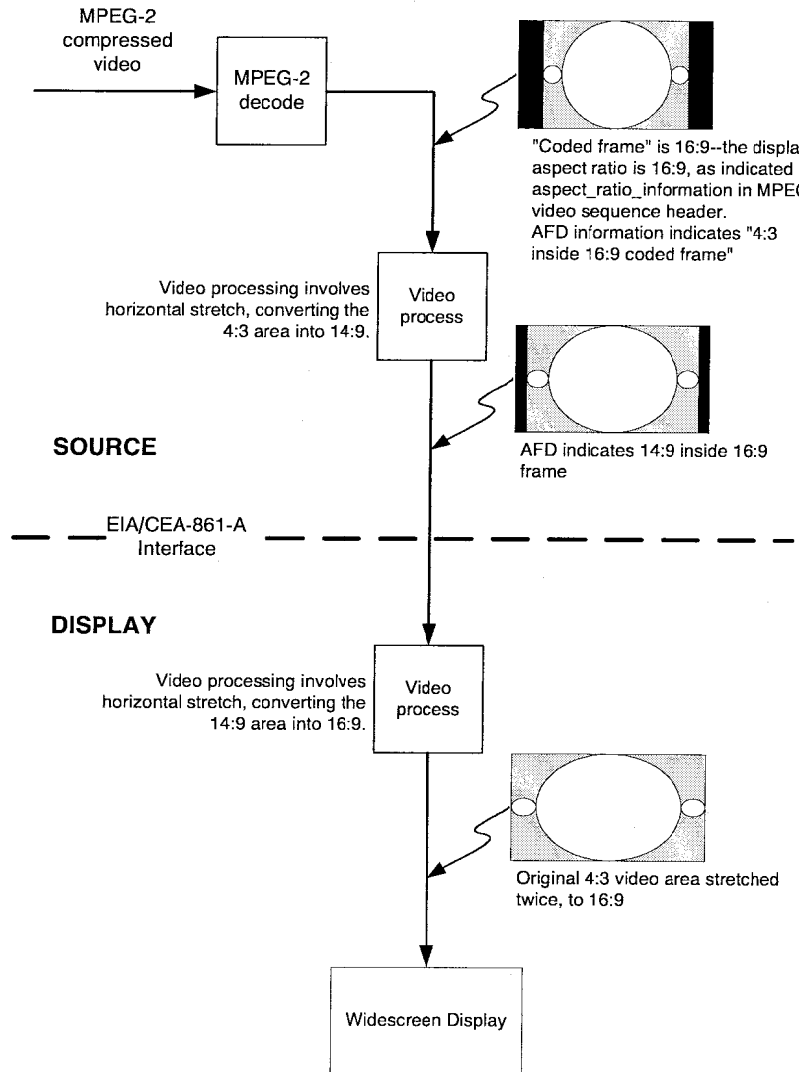

**Figure 43 Example of Problem Resulting from Double Stretch**

**Annex J Typical Audio Applications (Informative)**

Table 84 illustrates some typical audio applications.

Audio Type	Application	Constraints	References
LPCM	DVD-Video	Sample Rate = 48kHz or 96kHz. Sample Size = 16, 20, 24 bits Max Channels = 8	17
LPCM	DVD-Audio	Sample Rate = 44.1, 48, 88.2, 176.4, 192kHz Sample Size = 16, 20, 24 bits Max Channels = 6	18
One-Bit Audio	Super Audio CD	Sampling Rate = 2.8224MHz xx (DSD) (=64 x 44.1kHz) Sample Size = 1 bit Max Channels = 6	
AC-3	ATSC/SCTE	Sample Rate = 48kHz Max Bit Rate = 128, 192, 384, 448, 512kbps	21, 15
AC-3	DVD-Video	Sample Rate = 48kHz Max Bit Rate = 64, 448kbps	17
MPEG1 (layers 1 & 2)	MPEG Satellite	Sample Rate = 32, 44.1, 48kHz Max Bit Rate (layer 1) = 32, 64, 96, 128, 160, 192, 224, 256, 288, 320, 352, 384kbps Max Bit Rate (layer 2) = 32, 48, 56, 64, 80, 96, 112, 128, 160, 192, 224, 256, 320, 384kbps	21, 26
MPEG1 (layers 1 & 2)	DVD-Video	Sample Rate = 48kHz Max Bit Rate = 384kbps	17, 26
MPEG1 (layers 1 & 2)	DVB	Same as "MPEG Satellite"	22, 26
MPEG2	DVD-Video	Sample Rate = 48kHz Max Bit Rate = 528kbps, 912kbps for main plus extension.	17, 27
MPEG2	DVB	Max Bit Rate of Extension = 682kbps	22, 27
MP3 (MPEG1 layer 3)	MP3 Players	Sample Rate = 32, 44.1, 48kHz Max Bit Rate = 32, 40, 48, 56, 64, 80, 96, 112, 128, 160, 192, 224, 256, 320kbps	26
AAC (MPEG4)	Natural Audio Profile	Sampling Rate = 48, 96kHz	28

**Table 84 Some Typical Audio Applications**

### CEA Document Improvement Proposal

If in the review or use of this document, a potential change is made evident for safety, health or technical reasons, please fill in the appropriate information below and email, mail or fax to:

Consumer Electronics Association  
 Technology & Standards Department  
 2500 Wilson Blvd.  
 Arlington, VA 22201  
 FAX: 703 907-7693  
 standards@ce.org

Document No.	Document Title:
Submitter's Name: Submitter's Company:	Telephone No.: FAX No.: e-mail:
Address:	
Urgency of Change:  Immediate: <input type="checkbox"/> At next revision: <input type="checkbox"/>	
Problem Area: a. Clause Number and/or Drawing:   b. Recommended Changes:   c. Reason/Rationale for Recommendation:	
Additional Remarks:	
Signature:	Date:
<b>FOR CEA USE ONLY</b>	
Responsible Committee:	
Chairman:	
Date comments forwarded to Committee Chairman:	







