

RECOMMENDATION ITU-R BT.709-2*

**PARAMETER VALUES FOR THE HDTV STANDARDS FOR PRODUCTION
AND INTERNATIONAL PROGRAMME EXCHANGE**

(Question ITU-R 27/11)

(1990-1994-1995)

The ITU Radiocommunication Assembly,

considering

- a) that, already for many years, HDTV programmes have been produced in several countries;
- b) that parameter values for HDTV production standards should have maximum commonality;
- c) that two production standards, 1125/60/2:1 and 1250/50/2:1, have been defined for that purpose, having a significant number of parameters which have been agreed on a worldwide basis;
- d) that the parameters defined for both systems meet the quality goals set for HDTV;
- e) that equipment designed for the parameters of both the standards and embracing the whole range required for origination, processing and storage is widely available on the market;
- f) that high-quality conversion between those standards, as well as down-conversion to conventional television standards, has been successfully implemented;
- g) that a family of worldwide applicable new television standards, taking into account different quality requirements including HDTV as well as future digital transport mechanisms, will be defined in ITU-R (see Question ITU-R 213/11);
- h) that programmes produced and archived using those standards will not become obsolete on the advent of new digital production and distribution systems,

recommends

- 1 that for the production of HDTV programmes, one of the two systems described on the following pages, be used.

* The Administration of the United States of America does not support the principle of this Recommendation and must therefore take a reservation, because approval will be viewed as support of interim standards which will impede progress towards the completion of a single worldwide standard for studio production and international programme exchange.

**Signal parameter values for the 1125/60/2:1 system
and the 1250/50/2:1 system**

(The areas in bold characters in the tables below denote parameter values which have been agreed on a worldwide basis.)

1 Opto-electronic conversion

Item	Characteristics	
	Parameter	Value
		1125/60/2:1
1.1	Opto-electronic transfer characteristics before non-linear precorrection	Assumed linear
1.2	Overall opto-electronic transfer characteristics at source	$V = 1.099 L^{0.45} - 0.99$ for $1 \geq L \geq 0.018$ $V = 4.500 L$ for $0.018 > L \geq 0$ where: L : luminance of the image $0 \leq L \leq 1$ V : corresponding electrical signal
1.3	Chromaticity coordinates (CIE, 1931)	Coordinates
	Primary	x y
	– Red	0.640 0.330
	– Green	0.300 0.600
	– Blue	0.150 0.060
1.4	Assumed chromaticity for equal primary signals	D_{65}
	$E_R = E_G = E_B$	x y
	(Reference white)	0.3127 0.3290

2 Picture characteristics

Item	Characteristics	
	Parameter	Value
		1125/60/2:1
2.1	Aspect ratio	16:9
2.2	Sample per active line	1920
2.3	Sampling lattice	Orthogonal
2.4	Active lines per picture	1035 1152

3 Picture scanning characteristics

Item	Characteristics		
	Parameter	Value	
		1125/60/2:1	1250/50/2:1
3.1	Order of sample scanning	Left to right, top to bottom 1st line of field 1 above 1st line of field 2	
3.2	Interlace ratio	2:1	
3.3	Picture rate (Hz)	30	25
3.4	Total number of lines	1125	1250
3.5	Field frequency (Hz)	60	50
3.6	Line frequency (Hz)	$33\,750 \pm 0.001\%$	$31\,250 \pm 0.0001\%$

4 Signal format

The terms R , G , B , Y , C_B , C_R , are often used and are generally understood to refer to the signals E'_R , E'_G , E'_B , E'_Y , E'_{C_B} , E'_{C_R} respectively (i.e. they correspond to gamma pre-corrected signals).

Item	Characteristics		
	Parameter	Value	
		1125/60/2:1	1250/50/2:1
4.1	Conceptual non-linear precorrection of primary signals	$\gamma = 0.45$ (see § 1.2)	
4.2	Derivation of luminance signal E'_Y ⁽¹⁾	$E'_Y = 0.2126 E'_R +$ $0.7152 E'_G +$ $0.0722 E'_B$	$E'_Y = 0.299 E'_R +$ $0.587 E'_G +$ $0.114 E'_B$
4.3	Derivation of colour-difference signal (analogue coding) ⁽¹⁾	$E'_{C_B} = 0.5389 (E'_B - E'_Y)$ $E'_{C_R} = 0.6350 (E'_R - E'_Y)$	$E'_{C_B} = 0.564 (E'_B - E'_Y)$ $E'_{C_R} = 0.713 (E'_R - E'_Y)$
4.4	Derivation of colour-difference signal (digital coding) C_B , C_R	Digitally scaled from the values of item 4.3	

⁽¹⁾ The coefficients for the equations have been calculated following the rules laid down in SMPTE RP177-1993.

5 Analogue representation

Levels are specified in millivolts (mV) measured across a matched 75 Ω termination.

Item	Characteristics		
	Parameter	Value	
		1125/60/2:1	1250/50/2:1
5.1	Nominal level (mV) E'_R, E'_G, E'_B, E'_Y	Reference black: 0 Reference white: 700 (see Fig. 1)	
5.2	Nominal level (mV) $E^L_{C_B}, E^L_{C_R}$	± 350 (see Fig. 1)	
5.3	Form of synchronizing signal	Tri-level bipolar (see Fig. 2)	
5.4	Line sync timing reference	O_H (see Fig. 2)	
5.5	Sync level (mV)	$\pm 300 \pm 2\%$	
5.6	Sync signal timing	(See Table 1 and Fig. 3) Sync on all components	(See Fig. 4) – rise time – 50 ± 10 ns (between 10-90%) – see also ⁽¹⁾
5.7	Inter-component timing accuracy	Not applicable	± 2 ns
5.8	Blanking interval	(See Table 1 and Fig. 5)	(See Tables 2 and 3)
5.9	Nominal signal bandwidth (MHz)	30 (for all components)	

⁽¹⁾ When using *R, G, B* signals, the use of syncs on at least the green channel is advised; transmission of separate syncs is also acceptable. When using *Y, C_B, C_R* signals the *Y* signal at least carries sync.

FIGURE 3
Line synchronizing signal waveform for the 1125/60/2:1 system

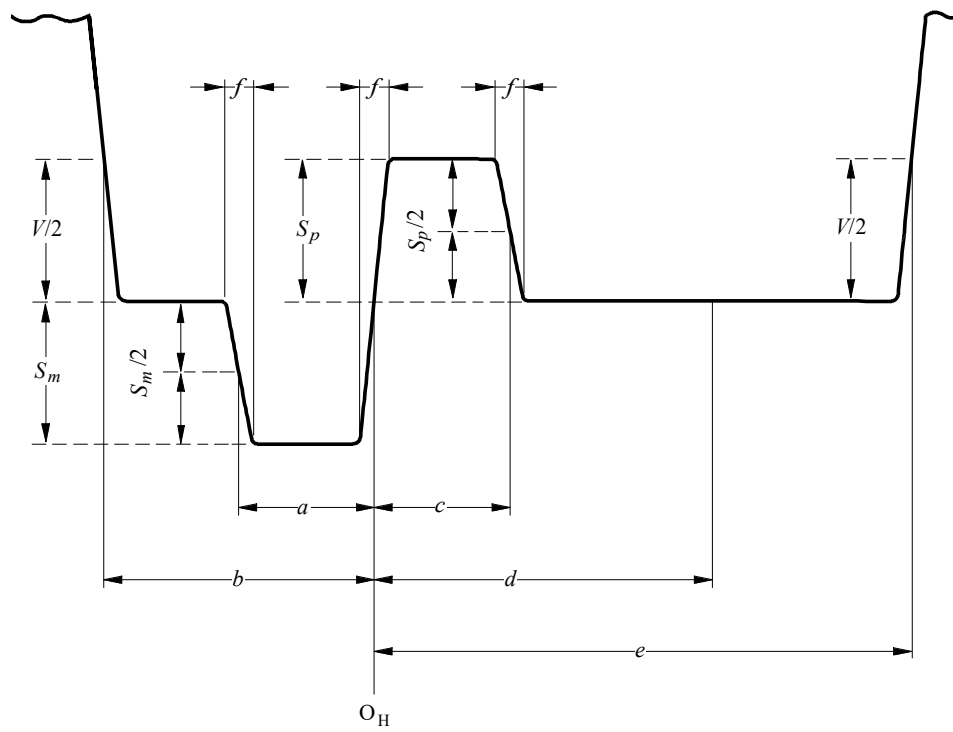

Line sync timing references

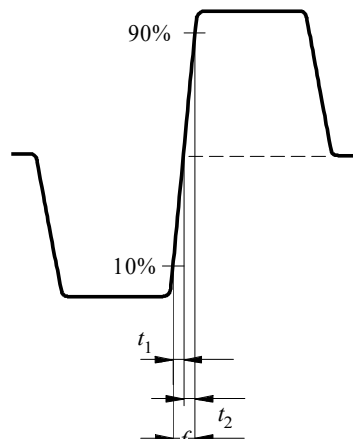

TABLE 1
 Level and timing specification of synchronizing signal
 of the 1125/60/2:1 system (see Figs. 3 and 5)

Symbol	Parameter	Nominal value	Reference clock intervals	Tolerance
<i>a</i>	Negative line sync width	0.593 μ s	44	$\pm 0.040 \mu$ s
<i>b</i>	End of active video	1.185 μ s	88	+0.080 μ s/-0 μ s
<i>c</i>	Positive line sync width	0.593 μ s	44	$\pm 0.040 \mu$ s
<i>d</i>	Clamp period	1.778 μ s	132	$\pm 0.040 \mu$ s
<i>e</i>	Start of active video	2.586 μ s	192	+0.080 μ s/-0 μ s
<i>f</i>	Rise/fall time	0.054 μ s	4	$\pm 0.020 \mu$ s
t_2-t_1	Symmetry of rising edge	-	-	$\pm 0.002 \mu$ s
S_m	Amplitude of negative pulse	300 mV	-	± 6 mV
S_p	Amplitude of positive pulse	300 mV	-	± 6 mV
V	Amplitude of video signal	700 mV	-	-
-	Field-blanking interval	45 H/field	99 000	-

FIGURE 4
 Line synchronizing signal waveform for the 1250/50/2:1 system

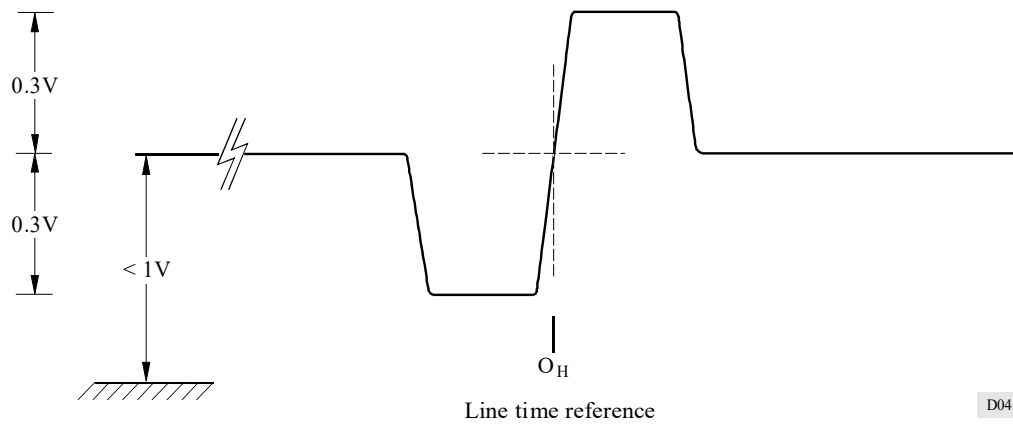
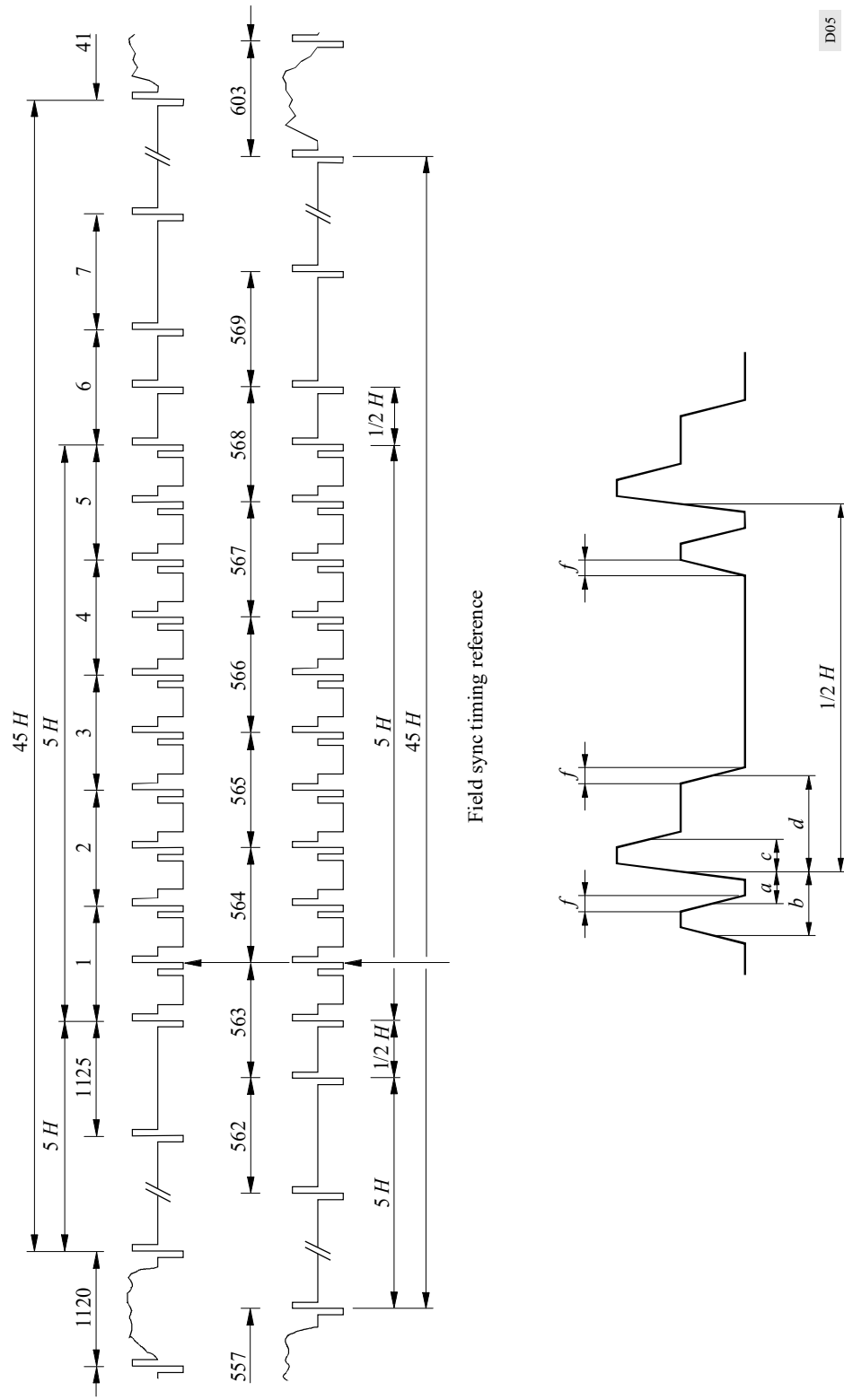

FIGURE 5
Field synchronizing signal waveform for the 1125/60/2:1 system



D05

TABLE 2

**Line timing details for the 1250/50/2:1 system
(see Figs. 4, 6 and 7)**

Item	Parameter	Time (µs)	2.25 MHz samples	72 MHz samples
1	Total line length	32	72	2 304
2	Active line length ⁽¹⁾			
	– digital	26.67	60	1 920
	– analogue	26.00	(58.5)	1 872
3	Line blanking ⁽²⁾			
	– digital	5.33	12	384
	– analogue	6.00	(13.5)	432
4	Front porch ⁽²⁾	0.89	2	64
5	Back porch ⁽²⁾	2.67	6	192
6	Tri-level sync half width (T-sync)	0.89	2	64
7	Field pulse	8.00	18	576

(1) Relative disposition of analogue and digital active lines assumed to be as per scaled version of Recommendation ITU-R BT.60 (Part A) (i.e. symmetrical). Analogue active line measured from the half-height of signal after line blanking. Rise and fall time assumed to be 15 ns but subject to ratification. Analogue blanking should preferably be applied at the studio or playout output.

(2) Front porch is defined at the interval between the end of active video and the half-height of the leading negative edge of the tri-level sync pulse. Similarly back porch is the interval between the half-height of the trailing negative edge of the tri-level sync and the start of active video (see Fig. 6).

TABLE 3

**Field timing details for the 1250/50/2:1 system
(see Figs. 7 and 8)**

Item	Parameter	Value/Description
1	Total number of lines per frame	1250
2	Total number of lines per field	625
3	Active lines per frame	1152
4	Active lines per field	576
5	Frame reference O_V	O_H on line 1
6	Frame indication	Line 1250
7	Field indication	Line 625
8	Active lines field 1	Lines 45 ... 620 inclusive
9	Active lines field 2	Lines 670 ... 1245 inclusive
10	Field blanking	Lines 1246 ... 44 and 621 ... 669 inclusive

FIGURE 6
 Line sync timing references for the 1250/50/2:1 system
 after *D/A* conversion and before final analogue blanking

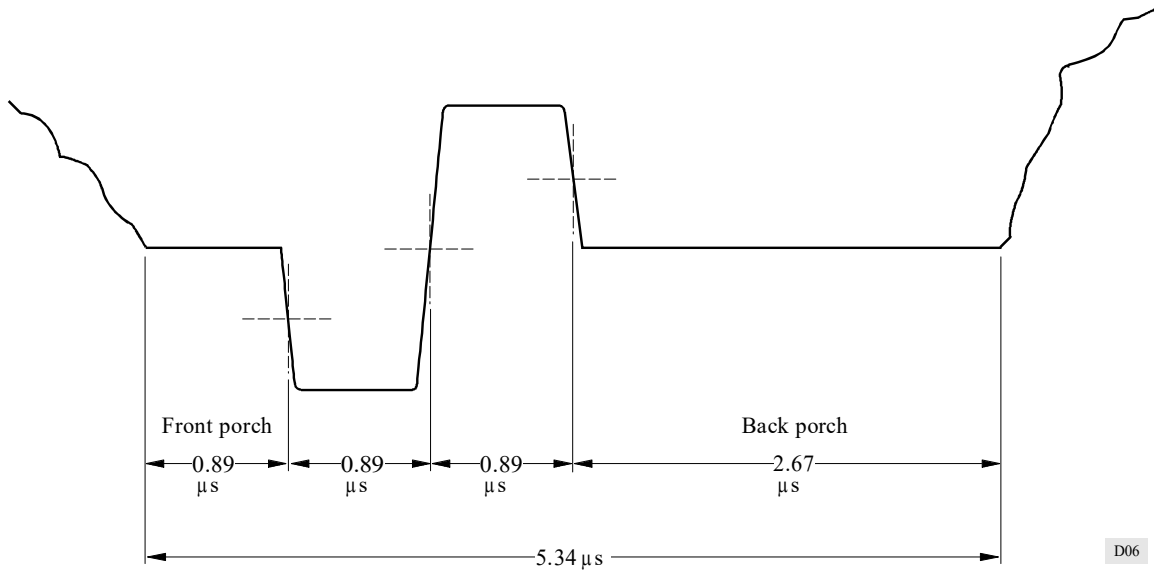

FIGURE 7
 Frame and field identification for the 1250/50/2:1 system

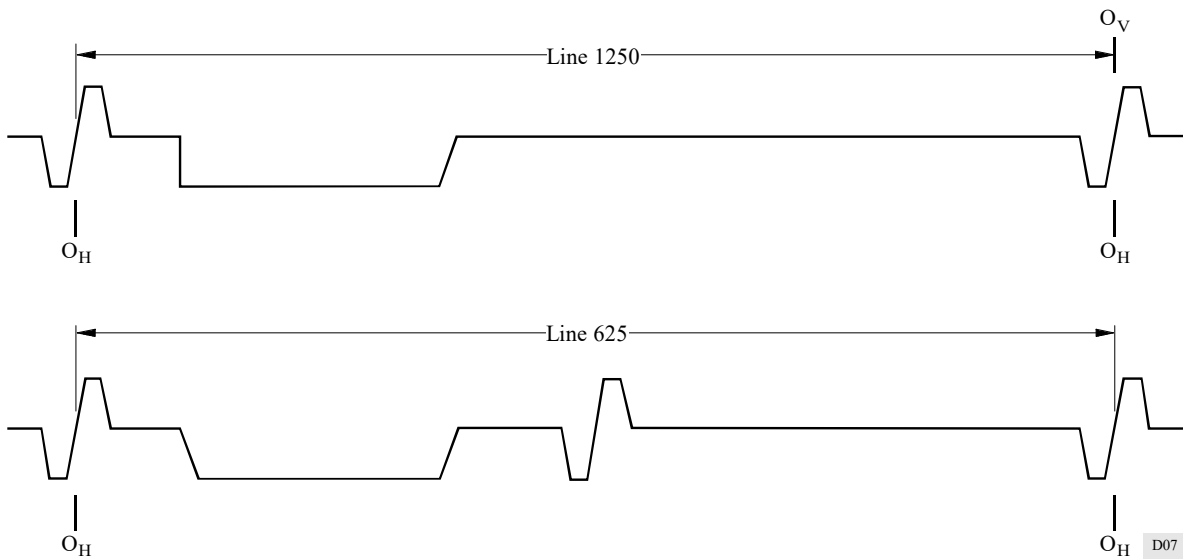
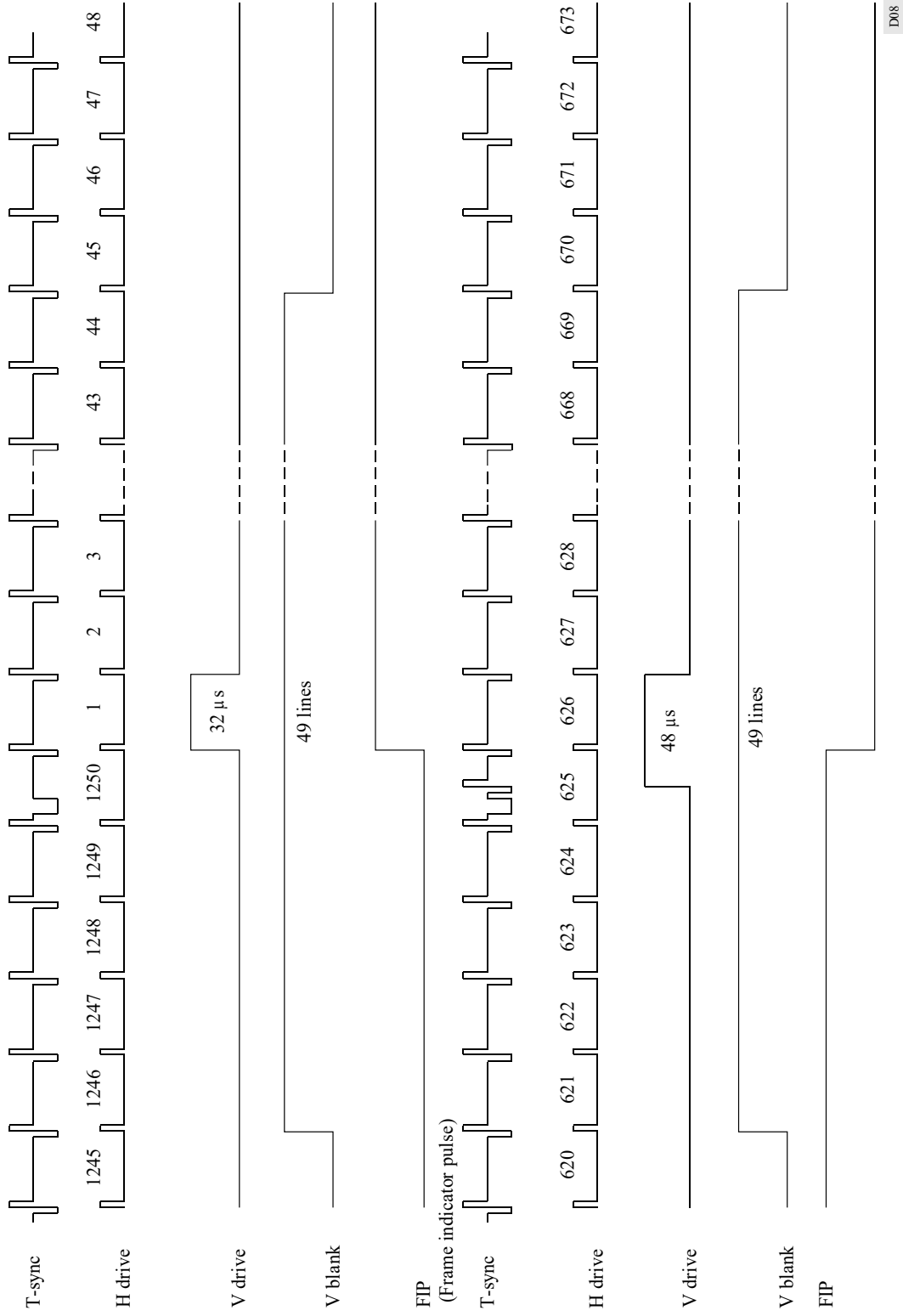

FIGURE 8
Timing of signals during the field-blanking interval
for the 1250/50/2:1 system



6 Digital representation

Item	Parameter	Characteristics	
		Value	
		1125/60/2:1	1250/50/2:1
6.1	Coded signal	R, G, B, or Y, C_B, C_R	
6.2	Sampling lattice – R, G, B, Y	Orthogonal, line and picture repetitive	
6.3	Sampling lattice signal – C_B, C_R	Orthogonal, line and picture repetitive co-sited with each other and with alternate⁽¹⁾ Y samples	
6.4	Sampling frequency (MHz) – R, G, B, Y	(Multiples of 2.25 MHz)	
		74.25 ± 0.001% (33 × 2.25)	72 ± 0.0001% (32 × 2.25)
6.5	Sampling frequency (MHz) – C_B, C_R	(Half of luminance sampling frequency)	
		37.125 ± 0.001% (33/2 × 2.25)	36 ± 0.0001% (32/2 × 2.25)
6.6	Number of samples per full line – R, G, B, Y – C_B, C_R	2200 1100	2304 1152
6.7	Active number of samples per line – R, G, B, Y – C_B, C_R	1920 960	
6.8	Coding format	Linear, 8 or 10 bit/component	
6.9	Timing relationship between the analogue synchronizing reference O_H and video data (in clock periods)	192	256
6.10	Quantization levels⁽²⁾ – Black level R, G, B, Y – Achromatic C_B, C_R – Nominal peak – R, G, B, Y – C_B, C_R	8 bit coding 16 128 235 16 and 240	
6.11	Quantization level assignment⁽³⁾ – Video data – Timing references⁽²⁾	8 bit coding 1 through 254 0 and 255	
6.12	Filter characteristics ⁽⁴⁾ – R, G, B, Y – C_B, C_R	See Fig. 9A See Fig. 9B	See Fig. 10A See Fig. 10B

(1) The first active colour-difference samples being co-sited with the first active luminance sample.

(2) For 1125/60/2:1 – In the case of 10 bit representation the two LSBs are ignored.

(3) For 1125/60/2:1 – For 10 bit coding two LSBs are added to the 8 bit code words.
For 1250/50/2:1 – 10 bit representation is under study.

(4) These filter templates are defined as guidelines.

FIGURE 9A
 Filter characteristics for *R*, *G*, *B* and *Y* signals
 for the 1125/60/2:1 system

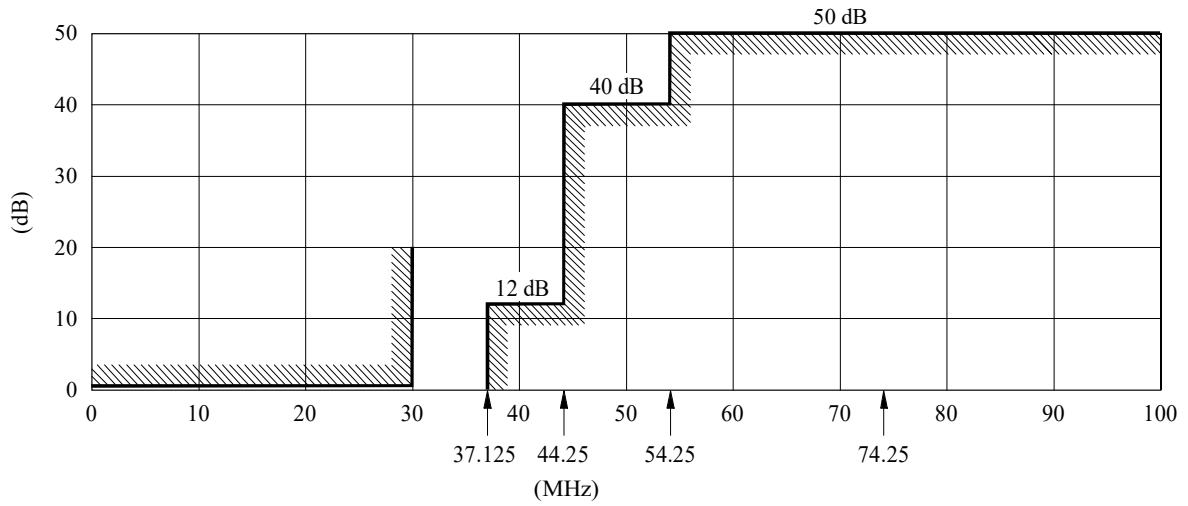

a) Template for insertion loss/frequency characteristic

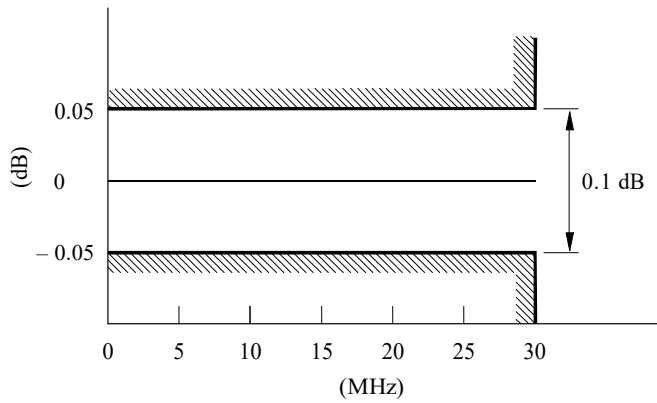

b) Passband ripple tolerance

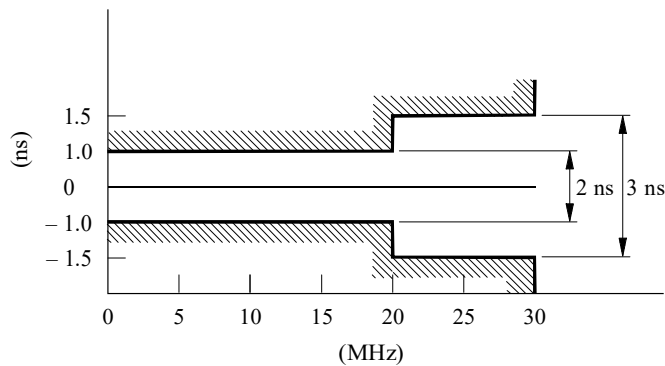

c) Passband group-delay tolerance

Note 1. The lowest frequency value in b) and c) is 100 kHz (instead of 0 MHz).

FIGURE 9B
 Filter characteristics for C_B and C_R signals
 for the 1125/60/2:1 system

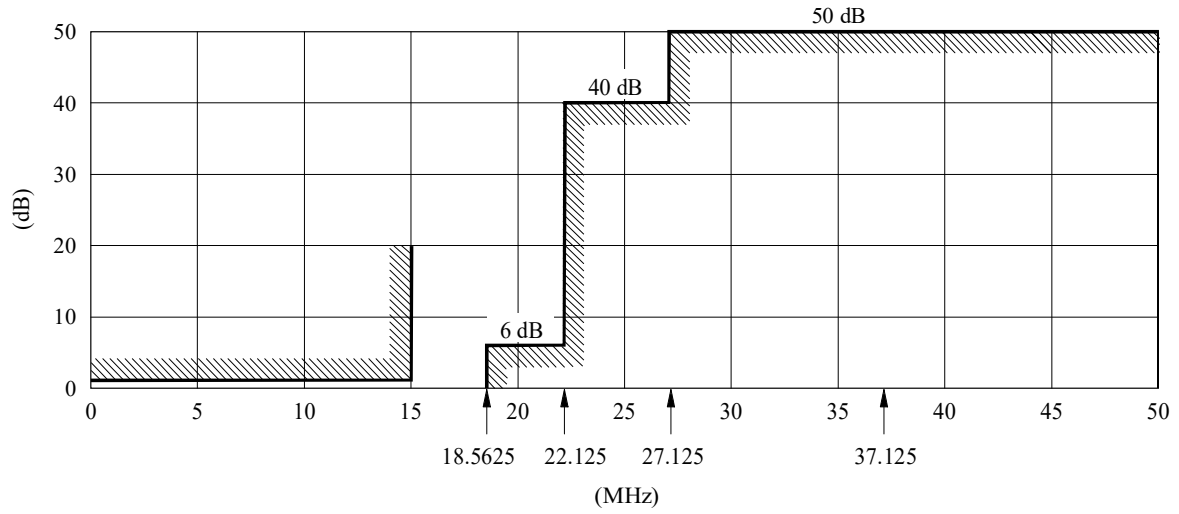

a) Template for insertion loss/frequency characteristic

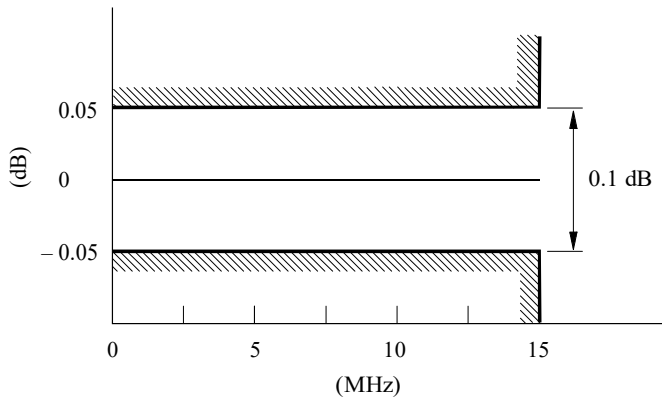

b) Passband ripple tolerance

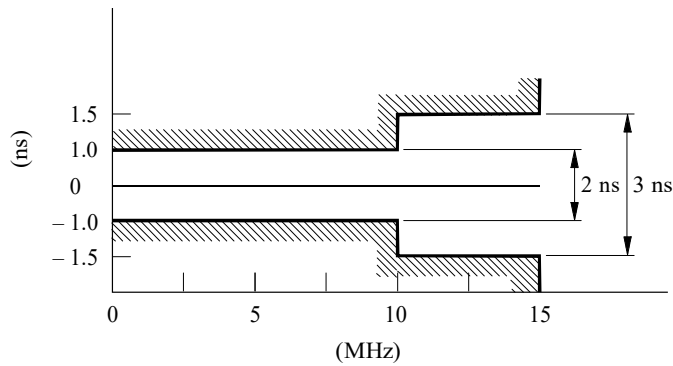

c) Passband group-delay tolerance

Note 1. The lowest frequency value in b) and c) is 100 kHz (instead of 50 MHz).

FIGURE 10A
Filter characteristics for R, G, B and Y signals
for the 1250/50/2:1 system

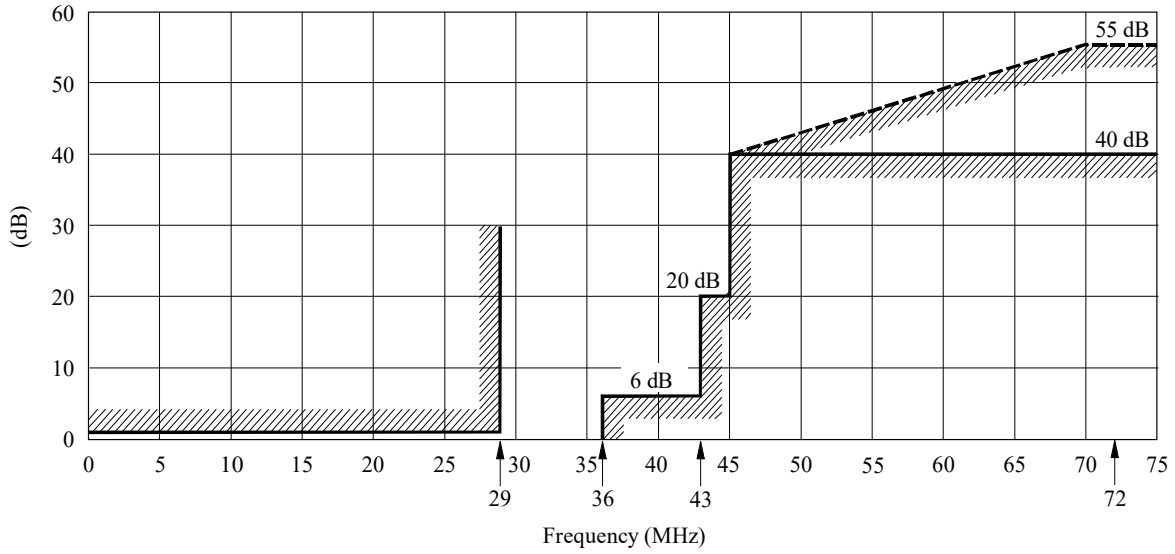

a) Template for insertion loss/frequency characteristic

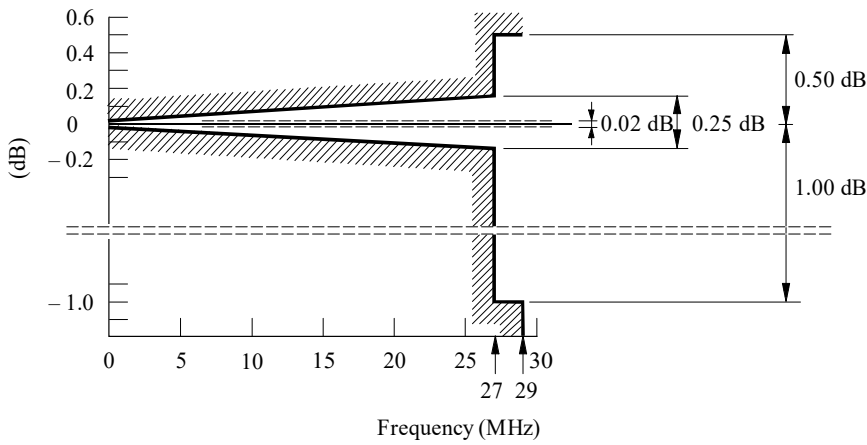

b) Passband ripple tolerance

Note 1 – In a digital implementation:

- the insertion loss should be at least 55 dB above 70 MHz (dashed-line template);

- the amplitude/frequency characteristic (on linear scales) should be skew-symmetric about the nail amplitude point;

- the group delay distortion should be zero by design.

Note 2 – Ripple and group delay are specified relative to their values at 5 kHz.

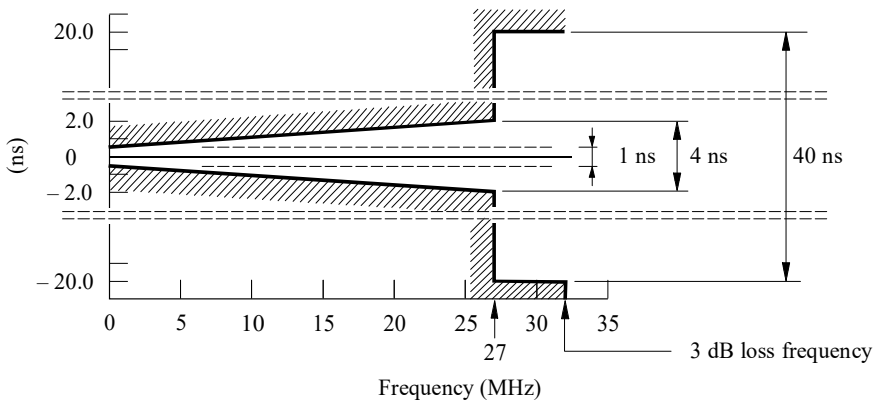

c) Passband group delay tolerance

FIGURE 10B
Filter characteristics for C_B and C_R signals
for the 1250/50/2:1 system

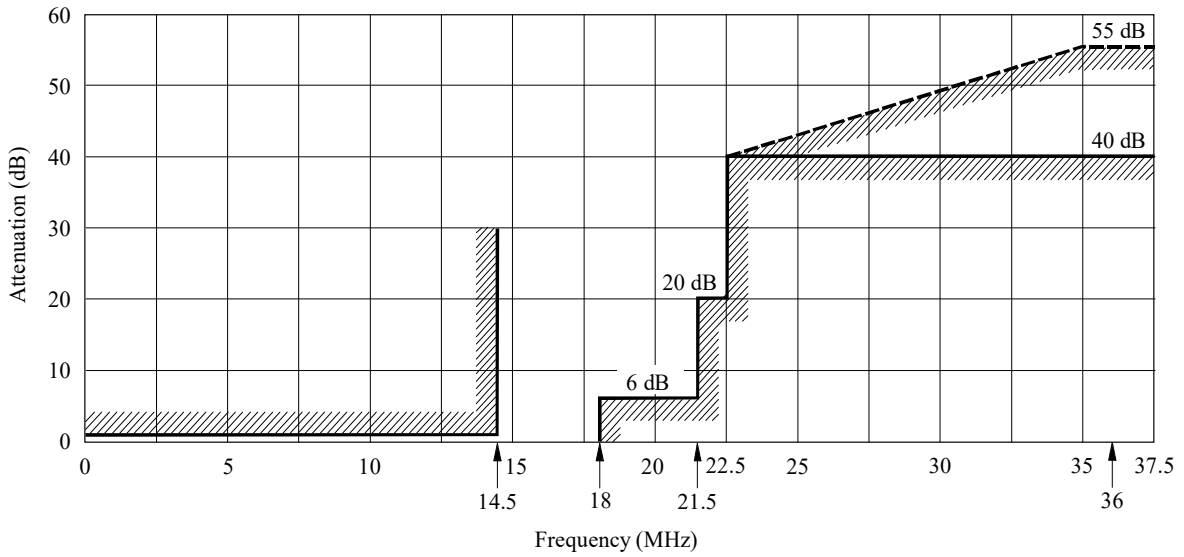

a) Template for insertion loss/frequency characteristic

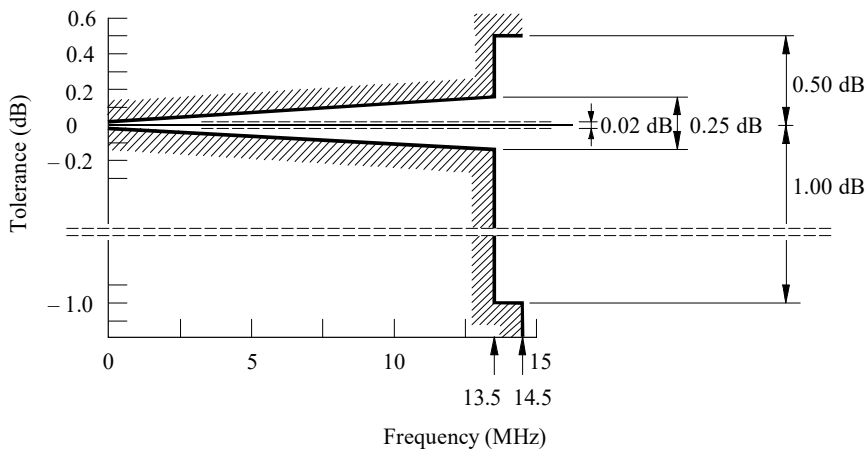

b) Passband ripple tolerance

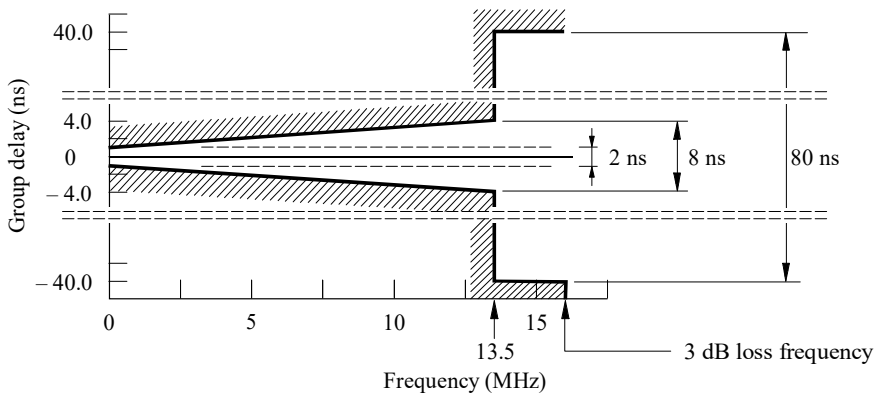

c) Passband group delay tolerance

Note 1 – In a digital implementation:

- the insertion loss should be at least 55 dB above 35 MHz (dashed-line template);
- the amplitude/frequency characteristic (on linear scales) should be skew-symmetric about the nail amplitude point;
- the group delay distortion should be zero by design.

Note 2 – Ripple and group delay are specified relative to their values at 5 kHz.

