

EIA STANDARD

A DTV Profile for Uncompressed High Speed Digital Interfaces

EIA/CEA-861-B

(Revision of EIA/CEA-861-A)

MAY 2002

ELECTRONIC INDUSTRIES ALLIANCE



NOTICE

EIA Engineering Standards and Publications are designed to serve the public interest through eliminating misunderstandings between manufacturers and purchasers, facilitating interchangeability and improvement of products, and assisting the purchaser in selecting and obtaining with minimum delay the proper product for his particular need. Existence of such Standards and Publications shall not in any respect preclude any member or nonmember of EIA from manufacturing or selling products not conforming to such Standards and Publications, nor shall the existence of such Standards and Publications preclude their voluntary use by those other than EIA members, whether the standard is to be used either domestically or internationally.

Standards and Publications are adopted by EIA in accordance with the American National Standards Institute (ANSI) patent policy. By such action, EIA does not assume any liability to any patent owner, nor does it assume any obligation whatever to parties adopting the Standard or Publication.

This EIA Standard is considered to have International Standardization implication, but the International Electrotechnical Commission activity has not progressed to the point where a valid comparison between the EIA Standard and the IEC document can be made.

This Standard does not purport to address all safety problems associated with its use or all applicable regulatory requirements. It is the responsibility of the user of this Standard to establish appropriate safety and health practices and to determine the applicability of regulatory limitations before its use.

(From Project No. 5016, formulated under the cognizance of the CEA R-4.8 DTV Interface Subcommittee.)

Published by

©ELECTRONIC INDUSTRIES ALLIANCE 2002
Technology Strategy & Standards Department
2500 Wilson Boulevard
Arlington, VA 22201

**PRICE: Please refer to the current
Catalog of EIA Electronic Industries Alliance Standards and Engineering Publications
or call Global Engineering Documents, USA and Canada (1-800-854-7179)
International (303-397-7956)**

All rights reserved
Printed in U.S.A.

PLEASE!

DON'T VIOLATE
THE
LAW!

This document is copyrighted by the EIA and may not be reproduced without permission.

Organizations may obtain permission to reproduce a limited number of copies through entering into a license agreement. For information, contact:

Global Engineering Documents
15 Inverness Way East
Englewood, CO 80112-5704 or call
U.S.A. and Canada 1-800-854-7179, International (303) 397-7956

A DTV Profile for Uncompressed High Speed Digital Interfaces

Contents

FOREWORD	1
1 INTRODUCTION	3
1.1 Summary of EIA/CEA-861X Requirements and Capabilities	3
2 GENERAL	5
2.1 Scope	5
2.2 Normative references	6
2.2.1 Normative reference list	6
2.2.2 Normative reference acquisition	6
2.3 Informative References	7
2.3.1 Informative document list	7
2.3.2 Informative document acquisition	9
2.4 Definitions	9
2.5 Symbols and abbreviations	12
2.6 Compliance Notation	13
3 OVERVIEW	14
3.1 General Requirements	14
4 VIDEO FORMATS AND WAVEFORM TIMINGS	18
4.1 Aspect Ratio	20
4.2 640x480p @59.94/60 Hz (Format 1)	22
4.3 1280x720p @59.94/60 Hz (Format 4)	23
4.4 1920x1080i @59.94/60 Hz (Format 5)	24
4.5 720x480p @59.94/60 Hz (Formats 2 & 3)	25
4.6 720(1440)x480i @59.94/60 Hz (Formats 6 & 7)	26
4.7 1280X720p @ 50 Hz (Format 19)	27
4.8 1920X1080i @ 50 Hz (Format 20)	28
4.9 720X576p @ 50 Hz (Formats 17 & 18)	29
4.10 720(1440)X576i @ 50 Hz (Formats 21 & 22)	30
4.11 720(1440)X240p @ 59.94/60 Hz (Formats (8 & 9)	31
4.12 (2880)X480i @ 59.94/60 Hz (Formats 10 & 11)	32
4.13 (2880)X240p @ 59.94/60 Hz (Formats 12 & 13)	34
4.14 1440X480p @ 59.94/60 Hz (Formats 14 & 15)	36
4.15 1920X1080p @ 59.94/60Hz (Format 16)	37
4.16 720(1440)X288p @ 50 Hz (Formats 23 & 24)	38
4.17 (2880)X576i @ 50Hz (Formats 25 & 26)	40
4.18 (2880)X288p @ 50 Hz (Formats 27 & 28)	42
4.19 1440X576p @ 50Hz (Formats 29 & 30)	44
4.20 1920X1080p @ 50 Hz (Format 31)	45
4.21 1920X1080p @ 23.97/24 Hz (Format 32)	46
4.22 1920X1080p @ 25 Hz (Format 33)	47
4.23 1920X1080p @ 29.97/30 Hz (Format 34)	48
4.24 Format Requirements Summary	49
5 COLORIMETRY AND QUANTIZATION	51
5.1 480p, 480i, 576p, 576i, 240p, and 288p	51
5.2 1080i, 1080p, and 720p	51

5.3	Recommendations on Conversions to/from Analog Signals	52
6	AUXILIARY INFORMATION CARRIED FROM SOURCE TO DTV MONITOR ...	53
6.1	Auxiliary Video Information (AVI) InfoFrame	53
6.1.1	Additional Requirements related to Version 2 AVI InfoFrame.....	55
6.1.2	Format of Version 1 AVI InfoFrame	56
6.1.3	Format of Version 2 AVI InfoFrame	60
6.2	Source Product Description (SPD) InfoFrame.	63
6.3	Audio InfoFrame.....	65
6.3.1	Audio Identification Information.....	66
6.3.2	Speaker Mapping and Down-mix Information	67
6.4	MPEG Source (MS) InfoFrame.	70
7	EDID Data STRUCTURE	73
7.1	Use of CEA EDID Timing Extensions.....	73
7.1.1	861 Implementation	74
7.1.2	Full 861A Implementation	74
7.1.3	Full 861B Implementation	74
7.2	Describing Video Formats in EDID.....	75
7.2.1	861 and 861A Implementations	75
7.2.2	Full 861B Implementation	75
7.2.3	Use of EDID 18-byte Detailed Timing Descriptors	76
7.2.4	Order of 18-byte Detailed Timing Descriptors (Backward Compatibility with 861)	76
7.2.5	Source Device Guidance	77
7.3	CEA EDID Timing Extension Version 1.....	77
7.4	CEA EDID Timing Extension Version 2.....	78
7.5	CEA EDID Timing Extension Version 3.....	79
	ANNEX A: EXAMPLE EDID 18-Byte Detailed Timing Descriptors	87
	ANNEX B: APPLICATION TO DVI 1.0	99
B.1	DVI Synchronization (informative).....	99
B.2	Connector and Cable	99
B.3	Digital Content Protection	99
B.4	Additional Information	99
	ANNEX C: APPLICATION TO Open LDI	101
C.1	Open LDI Data and Control Signals	101
C.2	Non DC Balanced Mode:	102
C.3	OpenLDI Cabling Information:.....	102
C.3.1	Cable Length.....	102
C.3.2	Number of Signal Conductors	102
C.3.3	Wire Gauge.....	102
C.3.4	Conductor Resistance.....	103
C.3.5	Insulation.....	103
C.3.6	Shield Requirement	103
C.3.7	Single Twisted Pair Transmission Skew	103
C.3.8	Multiple Twisted Pair Transmission Skew.....	103
C.3.9	USB Cable Requirements	103
C.3.10	DDC Cable Requirements.....	103

ANNEX D: Reserved for Future Use.....	104
ANNEX E: Reserved for Future Use.....	105
ANNEX F: Format Conversion Examples	106
ANNEX G: InfoPacket Framework.....	108
G.1 General Format of InfoPackets and InfoFrames	108
G.2 Types of InfoFrames	109
G.3 Example AVI InfoFrame in InfoPacket	111
ANNEX H: DVB Active Format Description	114
ANNEX I: Picture Aspect Ratio Conversion Example.....	116
ANNEX J: Typical Audio Applications	117

Table of Figures

Figure 1 Relationship of Different Versions of 861	2
Figure 2. Timing parameters for 640x480p @ 59.94/60 Hz.	22
Figure 3. Timing parameters for 1280x720p @ 59.94/60 Hz.	23
Figure 4. Timing parameters for 1920x1080i @ 59.94/60 Hz.....	24
Figure 5. Timing parameters for 720x480p @ 59.94/60 Hz.	25
Figure 6. Timing Parameters for 720(1440)X480i @ 59.94/60 Hz.	26
Figure 7. Timing parameters for 1280x720p @ 50 Hz.	27
Figure 8. Timing parameters for 1920x1080i @ 50 Hz.....	28
Figure 9. Timing parameters for 720x576p @ 50 Hz.	29
Figure 10. Timing Parameters for 720(1440)x576i @ 50 Hz.....	30
Figure 11. Timing Parameters for 720(1440)X240p @ 59.94/60 Hz.	31
Figure 12. Timing Parameters for (2880)X480i @ 59.94/60 Hz.	33
Figure 13. Timing Parameters for (2880)X240p @ 59.94/60 Hz.	35
Figure 14. Timing Parameters for 1440X480p @ 59.94/60 Hz.	36
Figure 15. Timing Parameters for 1920X1080p @ 59.94/60 Hz.	37
Figure 16. Timing Parameters for 720(1440)X288p @ 50 Hz.	39
Figure 17. Timing Parameters for (2880)X576i @ 50 Hz	41
Figure 18. Timing Parameters for (2880)X288p @ 50 Hz.	43
Figure 19. Timing Parameters for 1440X576p @ 50 Hz.	44
Figure 20. Timing Parameters for 1920X1080p @ 50 Hz.	45
Figure 21. Timing Parameters for 1920X1080p @ 23.97/24 Hz.	46
Figure 22. Timing Parameters for 1920X1080p @ 25 Hz.	47
Figure 23. Timing Parameters for 1920X1080p @ 29.97/30 Hz.	48
Figure 24 Speaker Placement.....	68
Figure 25. OpenLDI Synchronization	101
Figure 26. Example of options for format conversion	106
Figure 27. Multiple conversions example	107
Figure 28. Active Format Illustration.....	114
Figure 29. Example of problem resulting from double stretch	116

Table of Tables

Table 1 Summary of EIA/CEA-861X Requirements and Capabilities.....	4
Table 2. 861/861A Video Format Timing Requirements and their Relation to CEA Definitions.....	16
Table 3. New 861B Video Format Timings (all optional)	17
Table 4. Timing Parameters for the Uncompressed Digital Video Interface.....	19
Table 5. Summary of Video Format Requirements	49
Table 6. Formats new to this Standard (861B).....	50
Table 7. Auxiliary Video Information InfoFrame format (Version 1).....	56
Table 8. AVI InfoFrame Data Byte 1	57
Table 9. AVI InfoFrame Data Byte 2	57
Table 10. Common Active Formats	58
Table 11. AVI InfoFrame Data Byte 3	59
Table 12. Auxiliary Video Information (AVI) InfoFrame format (Version 2).....	60
Table 13. Video Identification Codes for AVI InfoFrame Data Byte 4 and CEA Short Descriptors	61
Table 14. AVI InfoFrame Data Byte 5	62
Table 15. Valid Pixel Repeat Values for each video format timing.....	63
Table 16. Source Product Description InfoFrame format	64
Table 17. Source Product Description InfoFrame Data Byte 25.....	65
Table 18. Audio InfoFrame format.....	66
Table 19. Audio InfoFrame Data Byte 1	67
Table 20. Audio InfoFrame Data Byte 2	67
Table 21. Speaker Placement	68
Table 22. Audio InfoFrame Data Byte 4	69
Table 23. Audio InfoFrame Data Byte 5, Level Shift Value	70
Table 24. Audio InfoFrame Data Byte 5, Down-mix Inhibit Flag.....	70
Table 25. MPEG Source InfoFrame format.....	71
Table 26. MPEG Source InfoFrame Data Byte 5	72
Table 27. CEA EDID Timing Extension Version 1 (originally defined in 861).....	78
Table 28. CEA EDID Timing Extension Version 2 (originally defined in 861A)	79
Table 29. CEA EDID Timing Extension Version 3 (new in 861B).....	81
Table 30. General Format of "CEA Data Block Collection"	82
Table 31. General Tag Format	83
Table 32. CEA Data Block Tag Codes	83
Table 33. CEA Short Audio Descriptor for uncompressed audio	83
Table 34. CEA Short Audio Descriptor for compressed audio	84
Table 35. Audio Format Codes	84
Table 36. Speaker Allocation Data Block Payload	85
Table 37. CEA Short Video Descriptor	85
Table 38. Example EDID Detailed Timing Descriptor for 1280X720p (60 Hz, 16:9) ...	87
Table 39. Example EDID Detailed Timing Descriptor for 1920X1080i (60 Hz, 16:9)...	88
Table 40. Example EDID Detailed Timing Descriptor for 720x480p (59.94Hz, 4:3)	89
Table 41. Example EDID Detailed Timing Descriptor for 720x480p (59.94Hz, 16:9) ..	90
Table 42. Example EDID Detailed Timing Descriptor for 720x480i (59.94Hz, 4:3)	91
Table 43. Example EDID Detailed Timing Descriptor for 720x480i (59.94Hz, 16:9) ...	92

Table 44. Example EDID Detailed Timing Descriptor for 1280X720p (50 Hz, 16:9) ... 93
Table 45. Example EDID Detailed Timing Descriptor for 1920X1080i (50 Hz, 16:9)... 94
Table 46. Example EDID Detailed Timing Descriptor for 720x576p (50 Hz, 4:3) 95
Table 47. Example EDID Detailed Timing Descriptor for 720x576p (50 Hz, 16:9) 96
Table 48. Example EDID Detailed Timing Descriptor for 720x576i (50 Hz, 4:3) 97
Table 49. Example EDID Detailed Timing Descriptor for 720x576i (50 Hz, 16:9) 98
Table 50. Synchronizing signal data for DVI 99
Table 51. OpenLDI Control Signals..... 102
Table 52. General Format of InfoPacket 109
Table 53. List of InfoFrame Type Codes 110
Table 54. Vendor Specific InfoFrame 111
Table 55. Example Version 1 AVI InfoFrame in InfoPacket (Informative) 112
Table 56. AFD Coding..... 115
Table 57. Some Typical Audio Applications 117

FOREWORD

This standard, EIA/CEA-861B (861B), is based on EIA/CEA-861 (861) that was published in January of 2001 and EIA/CEA-861A (861A) that was published in December 2001. This version adds:

- additional optional video formats
- more detailed discovery information
- short video descriptors so that new video formats can be advertised using 1 byte/format instead of 18-bytes/format
- audio descriptors to describe the various types of audio formats supported by the DTV Monitor
- Speaker allocation information to support multi-channel LPCM audio.
- miscellaneous information into the AVI InfoFrame to support several of the new video formats
- Several new InfoFrames to provide additional information about the source device and stream.

861B is fully backward compatible with 861A. It assumes the same functionality at the physical/link layers as is required to gain the extra functionality of 861A. For example, it relies on the ability of the source device to transmit CEA InfoPackets and the ability of the DTV Monitor to receive them. It supports the transmission of digital audio if the specific interface supports digital audio. Like 861A, 861B is fully backward compatible with 861 and requires the use of a backward compatible version of the interface used with 861 (e.g., DVI1.0). Source boxes designed to 861A or 861B will be able to supply video to an 861 compliant DTV Monitor and source boxes designed to 861 will be able to supply video to an 861A or 861B compliant DTV Monitor. In both of these cases, the system would have the same functionality as if both devices were only 861 devices. However, if both devices are designed to meet this full standard (EIA/CEA-861B), then the enhancements added in this standard and 861A would be available (e.g., aspect ratio information, active format information, native format information, etc.). For this to work, the versions of DVI or Open_LDI that are used with EIA/CEA-861B must have enhancements to carry CEA InfoPackets, but must also be backward compatible (source and destination) with the versions of those specifications referenced in EIA/CEA-861.

The relationship of the various versions of 861 is shown in Figure 1. Note that the potential functionality of each link is set by the lowest version of 861 on either side of the interface. The actual functionality depends on which options are implemented.

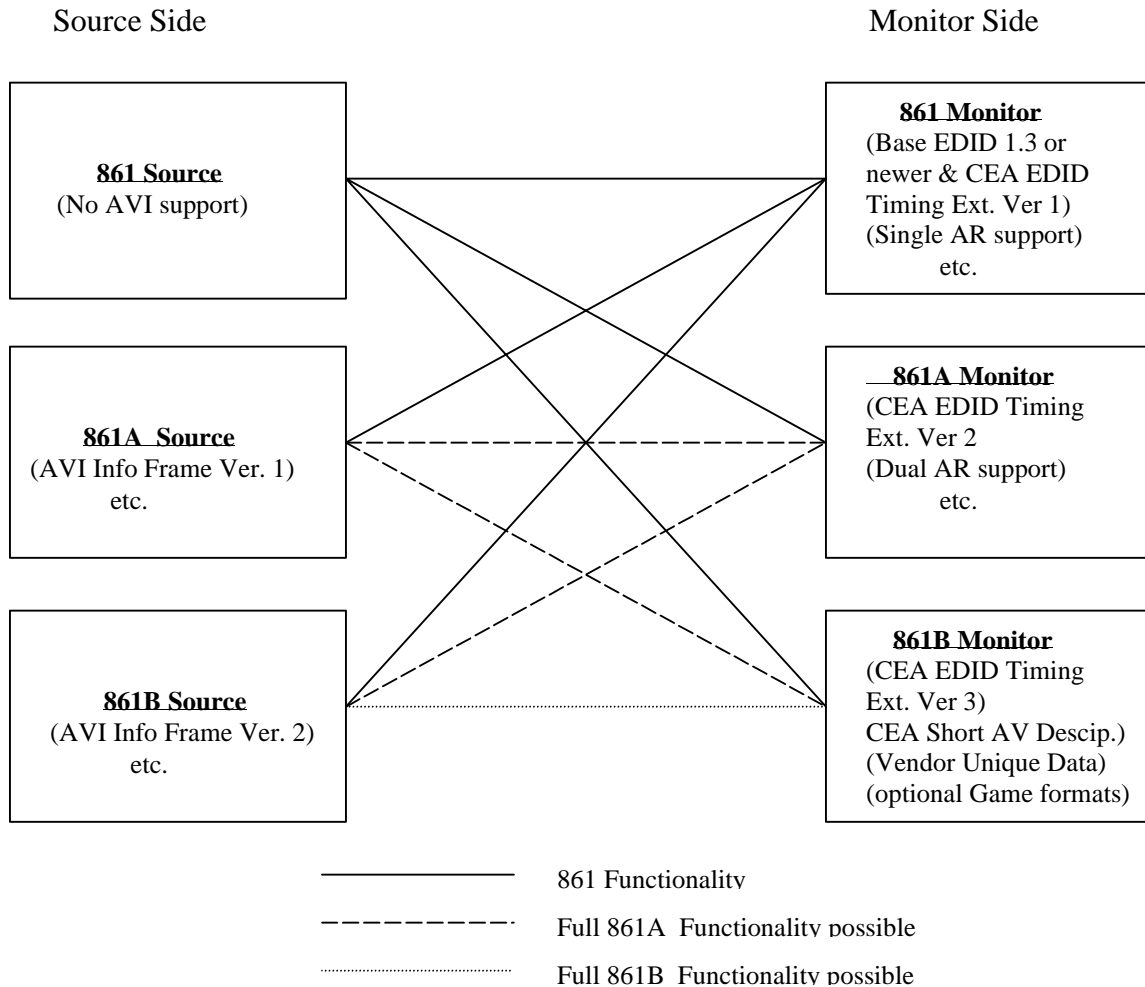

Figure 1 Relationship of Different Versions of 861

It is recommended that devices using the DTV profile defined in this standard incorporate a digital content protection system to ensure interoperability and provide protection for copy-protected content traversing uncompressed, digital, high-speed, baseband interfaces. For DVI 1.0 [2], High-bandwidth Digital Content Protection (HDCP) [4] technology is available for protecting content transmitted across this interface.

1 INTRODUCTION

This standard defines video timing requirements, discovery structures, and a data transfer structure (InfoPacket) that is used for building uncompressed, baseband, digital interfaces on digital televisions (DTV) or DTV Monitors. A single physical interface is not specified, but any interface implemented must use *VESA Enhanced Extended Display Identification Data Standard* (VESA E-EDID) for format discovery. At the time of this writing, there are two options for transmitting uncompressed digital video to the DTV Monitor. Digital Visual Interface (DVI) and OpenLDI have been available since the initial publication of 861 and allow for 861-functionality. Newer physical interfaces that are expected to be backward compatible with DVI 1.0 and include mechanisms for the transport of CEA InfoPackets, digital audio, and $YC_B C_R$ pixel data are expected to be available soon¹. These new interfaces can each be used separately to enable the full capabilities of this standard. All interfaces use VESA E-EDID to describe supported video formats in a way that can be discovered by the source device.

1.1 Summary of EIA/CEA-861X Requirements and Capabilities

A high level summary of the various requirements and capabilities of the different versions of 861 is shown below in Table 1. The table is for summary purposes only. Details of the requirements are found in the document text.

¹ Two companies/consortiums submitted responses to an RFI released by CEA in December 2001.

Table 1 Summary of EIA/CEA-861X Requirements and Capabilities

Source Side (sent in video frames)*	DTV Monitor Side (discovered at pwr up) *
EIA/CEA-861	Support
No AVI InfoFrame support Colorimetry: SMPTE 170M, ITU 601 (or EIA-770.2A), ITU-709 (or EIA-770.3). Quantization Levels: ITU 601; ITU-709.	EDTV: 640x480p, 720x480p; HDTV: 640x480p, 720x480p, and 1280x720p or 1920x1080i. E-EDID (only two 18 byte detail timing descriptors available in base EDID) and CEA EDID Timing Ext. Ver 1 for extra 18-byte descriptors. One preferred Aspect Ratio per video format timing (single AR monitors)
EIA/CEA-861A	Support
AVI Info Frame Ver. 1 Support - Sec. 6.1 - Aspect Ratio, Color, AFD, Bar width, over/under scan. Colorimetry: same as 861, except if a different one is specified in AVI Info Frame.	50Hz Timing Formats added CEA EDID Timing Ext. Ver 2 - Simultaneous support of 16x9 & 4x3 versions of same video timing. (Dual Aspect Ratio DTV) - Several native timing formats can be supported. - First format or AR listed is most preferred. - Basic audio indicator. - Y,Cb,Cr pixel formats.
EIA/CEA-861B	Support
AVI Info Frame Ver 2 – Sec. 6.1.1 Source Product Data InfoFrame (New) -- Sec. 6.2 Audio InfoFrame (new) – Sec. 6.3 MPEG Source InfoFrame (new) – Sec. 6.4	Optional Game/1080p formats CEA EDID Timing Ext. Ver. 3 -- Sec. 7.5 CEA Short Video Descriptors. CEA Short Audio Descriptors Speaker Allocation Data Block Vendor Unique Data Block

* Interface Requirements may have implications on both sides of the interface.

Note 1: Later versions of 861 are backward compatible with earlier versions, so later versions include all of the previous version's requirements and capabilities.

Note 2: If Ver 3 CEA Timing Ext. is implemented, all CEA formats, indicated in E-EDID for that monitor, shall use the Short Video Descriptor, even if they are also required to use 18-byte detailed timing descriptors.

Note 3: If the DTV Monitor has provided a timing descriptor for a particular video format decoded in the source, it is recommended that the source send video across the interface without performing format conversion. If a conversion must be done, it is recommended that the conversion be to a format identified by the display as a 'native format'. If for some reason the source cannot supply that format, the source should supply the next most preferred format, and so on to the last format advertised.

2 GENERAL

2.1 Scope

This standard includes mechanisms that allow a digital video source (such as a cable or terrestrial set-top box, digital VCR, or DVD player) to supply displayable, baseband, digital video to HDTV Monitors and EDTV Monitors (DTV Monitors), as defined in *CEA Expands Definitions for Digital Television Products* [16].

The timing requirements for video formats are described along with requirements for video format discovery. Also, a mechanism allowing the source device to discover all supported formats and the preferred formats of a DTV Monitor is described. Four basic video format timings from 861 are defined in this document for countries using 60 Hz systems. Two are high definition formats (1920x1080i, 1280x720p), one is enhanced definition (720x480p), and the remaining one is standard definition (720X480i). Additionally, six new 60 Hz format timings have been added in this standard (861B). All of these new formats are optional. Their discovery is handled somewhat differently than the previously defined formats due to the desire to reduce the number of bytes used to discover formats and at the same time maintain backward compatibility with 861 and 861A. Several of the video format timings (old and new) are available in two different picture aspect ratios. A method of indicating to the DTV Monitor the picture aspect ratio and colorimetry in which the video should be displayed is included. Several of the new video formats are game formats. These formats have 2880 pixels per line in the transmitted form, but the number of pixels displayed is less (based on a pixel repeat field).

For countries using 50 Hz systems, four similar video format timings from 861A have also been defined in this document. Two are high definition formats (1920x1080i, 1280x720p), one is enhanced definition (720x576p), and one is standard definition (720X576i). Additionally, six new 50 Hz format timings have been added in this standard (861B). All of these new formats are optional. Their discovery is handled somewhat differently than the previously defined formats due to the desire to reduce the number of bytes used to discover formats and at the same time maintain backward compatibility with 861 and 861A. Several of the video format timings (old and new) are available in two different picture aspect ratios. The method of indicating to the DTV Monitor the aspect ratio and colorimetry in which the video should be displayed also applies. Several of these new 50 Hz formats are also game formats.

An additional format added to 861B is a version based on a film frame rate (1920X1080p @ 24Hz). This format is available in only 16:9 picture aspect ratio.

This standard specifies how EDID is used to describe DTV capabilities to source devices. The ability to send colorimetry and picture aspect ratio information to the DTV was added in 861A. 861B adds other types of information that can optionally be sent to the DTV.

2.2 Normative references

The following standards contain provisions that, through reference in this text, constitute normative provisions of this standard. At the time of publication, the editions indicated were valid. All standards are subject to revision, and parties to agreements based on this standard are encouraged to investigate the possibility of applying the most recent editions of the standards listed in Sec. 2.2.1. If the referenced standard is dated, the reader is advised to use the version specified.

2.2.1 Normative reference list²

1. ANSI/SMPTE 170M-1999 Composite Analog Video Signal—NTSC for Studio Applications, 1999.
2. DDWG, “Digital Visual Interface,” Revision 1.0, April 2, 1999.
3. ETSI TR 101 154 v1.4.1, *Digital Video Broadcasting (DVB); Implementation Guidelines for the Use of MPEG-2 Systems, Video and Audio in Satellite, Cable and Terrestrial Broadcasting Applications (Annex B)*, July 2000.
4. Intel, High-bandwidth Digital Content Protection System, Version 1.0, February 17, 2000.
5. ITU-R BT.601-5, Studio Encoding parameters of digital television for standard 4:3 and wide-screen 16:9 aspect ratios, 1995.
6. ITU-R BT.709-4, Parameter Values for the HDTV standard for production and International Programme Exchange, 2000.
7. Open LVDS Display Interface (Open LDI) Specification,” Version 0.95, May 13, 1999.
8. VESA E-EDID™ Standard, *VESA Enhanced Extended Display Identification Data Standard*, Release A, Revision 1, February 9, 2000.
9. VESA E-DDC™ Standard, *VESA Enhanced Display Data Channel Standard*, Version 1, September 2, 1999.
10. VESA Monitor Timing Specifications, *VESA and Industry Standards and Guidelines for Computer Display Monitor Timing*, Version 1.0, Revision 0.8, Adoption Date: September 17, 1998.

2.2.2 Normative reference acquisition

AEIA/CEA Standards

- Global Engineering Documents, World Headquarters, 15 Inverness Way East, Englewood, CO USA 80112-5776; Phone 800-854-7179; Fax 303-397-2740
URL global.ihs.com; Email global@ihs.com

ANSI/EIA Standards: United States of America

- American National Standards Institute, Customer Service, 11 West 42nd Street, New York NY 10036; Phone 212-642 4900; Fax 212-302-1286
URL www.ansi.org; Email sales@ansi.org

² In some instances, only specified sections of a standard may be normative. References listed below shall take precedence over references within these listed references.

ANSI/SMPTE Standards

- Society of Motion Picture and Television Engineers, 595 W. Hartsdale Avenue, White Plains, NY 10607-1824, Phone 914-761-1100, Fax 914-761-3115

URL www.smpte.org

DDWG

- Contact Digital Display Working Group (DDWG); Attn: DDWG Administrator; M/S JF3-361; 2111 NE 25th Avenue, Hillsboro, OR 97124-5961, USA; Fax: (503)264-5959; Email: ddwg.if@intel.com; URL: www.ddwg.org

HDCP

- Contact Digital Content Protection, LLC; EMail: info@digital-cp.com; URL: www.digital-cp.com

ITU Standards

- International Telecommunications Union, Place des Nations, CH-1211 Geneva 20, Switzerland; Phone +41 22 730 5111; Fax +41 22 733 7256
URL www.itu.sh/publications/bookstore.html; Email itumail@itu.int

OpenLDI

- Contact National Semiconductor: WWW.National.com/appinfo/fpd

VESA Standards

- Contact Video Electronics Standards Association, 920 Hillview Court, Suite 140, Milpitas, CA 95035, USA; telephone: (408) 957-9270
URL www.vesa.org.

2.3 Informative References

The following documents contain information that is useful in understanding this standard. Some of these documents are drafts of standards that may become normative references in a future release of this standard.

2.3.1 Informative document list

11. ANSI/SMPTE Standard 253M (1998), Standard for Television—Three-Channel RGB Analog Video Interface.
12. ANSI/SMPTE Standard 274M (1998), Standard for Television—1920X1080 Scanning and Analog and Parallel Digital Interfaces for Multiple-Picture Rates.
13. ANSI/SMPTE Standard 293M (1996), Standard for Television—720X483 Active Line at 59.94 Hz Progressive Scan Production—Digital Representation.
14. ANSI/SMPTE 296M (2001), Standard for Television—1280 X720 Scanning, Analog and Digital Representation and Analog Interface.
15. ATSC Standard A/52, Digital Audio Compression (AC-3) Standard, December 20, 1995.
16. CEA Press Release; *CEA Expands Definitions for Digital Television Products*; August 31, 2000.

17. DVD Forum, *DVD Specifications for Read-Only Disc, Part3, Video Specifications*, Version 1.0, August 1996.
18. DVD Forum, *DVD Specifications for Read-Only Disc, Part 4, Audio Specifications*, Version 1.0.
19. EIA/CEA-770.2-C, *Standard Definition TV Analog Component Video Interface*, August 2001.
20. EIA/CEA-770.3-C, *High Definition TV Analog Component Video Interface*, August 2001.
21. EIA/CEA-849A, *Application profiles for EIA-775A compliant DTVs*, 2001
22. EIA/CEA-861, *A DTV Profile for Uncompressed High Speed Digital Interfaces*, January 2001.
23. EIA/CEA-861A, *A DTV Profile for Uncompressed High Speed Digital Interfaces*, December 2001.
24. ETSI TR 101 154 v1.4.1, *Digital Video Broadcasting (DVB); Implementation Guidelines for the Use of MPEG-2 Systems, Video and Audio in Satellite, Cable and Terrestrial Broadcasting Applications*, July 2000.
25. IEC61937 *Digital Audio - Interface for non-linear PCM encoded audio bitstreams applying IEC60958*, First Edition, 2000.
26. IEC60958-1 *Digital Audio Interface - Part 1: General*, First Edition, 1999.
27. IEC60958-3 *Digital Audio Interface - Part 3: Consumer Applications*, First Edition, 1999.
28. ISO/IEC 11172-3:1993, *Information Technology - Coding of moving pictures and associated audio for digital storage media at up to about 1.5 Mbit/sec*, Part 3: Audio, 1993.
29. ISO/IEC 13818-3, *Information Technology - Generic coding of moving pictures and associated audio information, Part 3: Audio*, Second Edition, 1998-04-15.
30. ISO/IEC 14496-3, *Information Technology - Coding of audio-visual objects, Part 3: Audio, Amendment 1: Audio Extensions*, 2000-09-15.
31. ITU-R BT.1358, *Studio Parameters of 625 and 525 Line Progressive Scan Television Systems*, 1998.
32. ITU-R BT.470-6, *Conventional Television Systems*, 1998.
33. ITU-R BT.656-4, *Interfaces for Digital Component Video Signals in 525-line and 625-line Television Systems Operating at the 4:2:2 Level of Recommendation*, 1998.
34. ITU-R BT.711-1, *Synchronizing Reference Signals for the Component Digital Studio*, 1992.
35. VESA DDC/CI Standard, *VESA Display Data Channel Command Interface (DDC/CI) Standard*, Version 1, August 14, 1998.
36. VESA DI-EXT, *Display Information Extension Block (DI-EXT™) for E-EDID*, Release A, August 21, 2001.
37. VESA E-EDID™ Implementation Guide, *VESA Enhanced Extended Display Identification Data—Implementation Guide*, Version 1.0, June 4, 2001.
38. VESA GTF Standard, *VESA Generalized Timing Formula Standard*, Version 1.1, September 2, 1999.

2.3.2 Informative document acquisition

EIA/CEA Standards

- Global Engineering Documents, World Headquarters, 15 Inverness Way East, Englewood, CO USA 80112-5776; Phone 800-854-7179; Fax 303-397-2740
URL global.ihs.com; Email global@ihs.com

ITU Standards

- International Telecommunications Union, Place des Nations, CH-1211 Geneva 20, Switzerland; Phone +41 22 730 5111; Fax +41 22 733 7256
URL www.itu.sh/publications/bookstore.html; Email itumail@itu.int

SMPTE Standards

- Society of Motion Picture & Television Engineers (SMPTE), 595 West Hartsdale Avenue, White Plains, NY 10607; Phone 914-761-1100; Fax 914-761-3115
URL www.smpte.org; Email smpte@smpte.org

VESA Standards

- Contact Video Electronics Standards Association, 920 Hillview Court, Suite 140, Milpitas, CA 95035, USA, telephone (408) 957-9270, www.vesa.org.

2.4 Definitions

For the purposes of this document, the following definitions apply.

Active Format Description	A data structure that describes what portion of the picture actually contains useful information (i.e., letterbox and sidebars [bars] are not considered useful information). It is standardized in DVB, and is partially adopted in this standard. Note that the use of the term “active” in this definition is not consistent with the use of this term in other portions of this standard and most of the other documents referenced by this standard.
Auxiliary Video Information	Additional information (defined in this standard) related to the video being sent from a source device to a DTV Monitor.
A/V	Audio and Video.
Bars	Region of the display screen that is being driven or scanned at either zero luminance or at a uniform luminance; or regions of a picture that are intended to be driven (e.g., matrix addressed) or scanned (e.g., CRT) at either zero luminance or at a uniform luminance. In other words, it is the portion of the picture that does not contain useful information.
Basic Audio	Uncompressed, two channel, digital audio. Exact parameters are determined by the interface specification used with this standard (e.g., 2 channel IEC60958 LPCM, 32, 44.1, and 48 kHz sampling rates, 16 bits/sample).

Byte	8 bits of data.
CEA Timing Extension	The E-EDID Standard [8] defines a tag (02 ₁₆) that allows for an extension to be added with additional timing formats. When EIA/CEA-861 was written, the format of this “Additional Timing Data Block” was still being determined by VESA. Subsequent to the adoption of EIA/CEA-861, the tag for this timing extension was assigned to CEA for use in EIA/CEA-861A and subsequent editions. This standard (861B) specifies new requirements for the use of this timing extension (see Section 7.1.3).
Digital Television (DTV)	A device that receives, decodes, and presents audio and video material that has been transmitted in a compressed form. The device can be a single unit or it can be constructed from a number of individual components (e.g. a digital terrestrial set top box and an analog television).
DTV Monitor	Defined in this standard to be an EDTV, HDTV, or SDTV Monitor. A DTV Monitor can also be any combination of these terms. A DTV with an uncompressed video input is also considered a DTV Monitor.
Dual Aspect Ratio DTV Monitor	A DTV Monitor that simultaneously supports both picture aspect ratios of a video format timing (e.g., 720X480p). Simultaneous support is signified by listing both formats in the EDID data structure at the same time.
EDTV Monitor	A video monitor capable of displaying 720x480p in 16:9 or 4:3 aspect ratios.
Frame Format	The timing associated with a single frame of video.
HDTV Monitor	A video monitor capable of displaying 1920X1080i or 1280X720p video in its native format on a 16:9 screen. An HDTV Monitor must also have EDTV Monitor capabilities.
InfoFrame	A substructure within the CEA InfoPacket. InfoFrames are specific to the type of information (e.g., Audio InfoFrame). Various InfoFrames are described in Section 6.
InfoPacket	A data transfer structure for sending miscellaneous information from a source device to a DTV monitor over an 861B interface. This structure first appeared in 861A. The general structure is shown in Annex G.
Multi-channel LPCM Audio	Multi-channel Linear Pulse Code Modulation (i.e., uncompressed) digital audio with more than two channels.

Native Display Device Aspect Ratio	Ratio of maximum width to height dimension of the addressable portion of a physical display device screen.
Native Format	A Native Format is a video timing/format that a display device is designed to handle without having to perform a timing or scaling conversion. The number of "native" formats is dependent upon the design of the display device. Each device declares its native format or formats through EDID.
Picture	That portion of an uncompressed video signal, a compressed video stream, or a sequence on a display that constitutes a single displayable image (i.e., the addressable picture elements). For the purposes of this standard, picture refers to a single video frame in the uncompressed video signal.
Picture Aspect Ratio	Ratio of width to height dimension of the picture as delivered across the uncompressed digital interface, including any top, bottom, or side bars. Only two Picture Aspect Ratios are specified for this interface, 16:9 and 4:3.
Preferred Picture Aspect Ratio	In a Dual Aspect Ratio DTV Monitor, the preferred aspect ratio of a given Video Format Timing (e.g., 720X480p) is the aspect ratio of the format listed before the Video Format with the same Video Format Timing in the EDID data structure (see Section 7). This would be the picture aspect ratio that would be displayed if a DTV Monitor were to receive a Video Format Timing with no accompanying picture aspect ratio information (i.e., no AVI sent from source).
Preferred Format	The preferred format is the video format listed first in the EDID data structure. Although there may be more than one native format, the one most preferred by the DTV Monitor is listed first.
RGB	A general representation of an analog or digital component video signal, where R represents the red color, G represents green, and B represents blue; and each component is sampled at a uniform rate (4,4,4). For the purpose of this standard, the signal is digital.
SDTV Monitor	A video monitor capable of displaying 720X480i video in at least one of two aspect ratios, 16:9 or 4:3.
Video Format	A video format is sufficiently defined such that when it is received at the DTV Monitor, the DTV Monitor has enough information to properly display the video to the user. The definition of each format includes a Video Format Timing, the Picture Aspect Ratio, and a Colorimetry Space.

Video Format Timing	The waveform associated with a video format. Note that a specific Video Format Timing may be associated with more than one Video Format (e.g., 720X480p@4:3 and 720X480p@16:9).
Y_{C_B}C_R	A general representation of a digital component video signal, where Y represents luminance, C _B represents the color blue, and C _R represents red; The color component may be sub-sampled at half the rate as luminance (4:2:2) or may be sampled at a uniform rate (4:4:4). For the purposes of this standard, it may be considered a digitized form of Y, P _B , P _R .

2.5 Symbols and abbreviations

861	EIA/CEA-861
861A	EIA/CEA-861A
861B	EIA/CEA-861B (this standard)
AFD	Active Format Description
ANSI	American National Standards Institute
A/V	Audio/Video
AR	Aspect Ratio
AV/C	Audio/Video Control
AVI	Auxiliary Video Information
CPU	Central Processing Unit
DBS	Direct Broadcast Satellite
DDWG	Digital Display Working Group
DSC	Digital Still Camera
DTV	Digital Television
DVC	Digital Video Camera
DVD	Digital Versatile Disk
D-VHS	Digital VHS
DVI	Digital Visual Interface [2]
E-DDC	Enhanced Display Data Channel
E-EDID	Enhanced Extended Display Identification Data Standard
EDTV	Enhanced Definition Television
EIA	Electronic Industries Alliance
EUI	Extended Unique Identifier
HDCP	High-bandwidth Digital Content Protection [4]
HDD	Hard Disk Drive
HDTV	High Definition Television
IEC	International Electrotechnical Commission
IEEE	Institute of Electrical and Electronics Engineers
ISO	International Organization for Standardization
ITU	International Telecommunications Union
LAN	Local Area Network
lsb	least significant bit
LVDS	Low Voltage Differential Signaling

MPEG	Moving Picture Experts Group
msb	most significant bit
MTS	Monitor Timing Specification (a specific VESA standard)
OpenLDI	Open LVDS Display Interface [7]
OSD	On-Screen Display
OUI	Organization Unique Identifier
SDTV	Standard Definition Television
SMPTE	Society of Motion Picture & Television Engineers
STB	Set-Top Box
VESA	Video Electronics Standards Association

2.6 Compliance Notation

As used in this document, “*shall*” and “*must*” denote mandatory provisions of the standard. “*Should*” denotes a provision that is recommended but not mandatory. “*May*” denotes a feature whose presence does not preclude compliance and implementation of which is optional. “*Optional*” denotes items that may or may not be present in a compliant device.

3 OVERVIEW

This document describes requirements on DTV Monitors that include an uncompressed, baseband, digital video interface. These requirements apply to any baseband digital video interface that makes use of VESA E-EDID (structures for discovery of supported video formats) [8] and supports 24-bit RGB at the proper timing. The 60 Hz/59.94 Hz video timings originally defined in 861 are based on analog formats already standardized in EIA-770.2-C [19] and EIA-770.3-C [20]. A preferred physical/link interface is not specified in this standard. See the annexes on how to apply this standard to the individual interfaces available at the time of this writing. Digital Visual Interface (DVI 1.0) [2] and OpenLDI 0.95 [7] were available at the time 861 was first published and can be used to enable an 861-level of functionality. This standard has been enhanced several times since its original release in January 2001. To take advantage of these enhancements, the physical interface also needs a way to transport CEA InfoPackets, digital audio, and $Y C_B C_R$ pixels from the source device to the DTV Monitor. Several systems are being developed to take advantage of these enhancements¹.

Enhanced Extended Display Identification Data (E-EDID) was created by VESA to enable plug and play capabilities of monitors. This data, which would be stored in the DTV Monitor, describes video formats that the DTV Monitor is capable of receiving and rendering. The information is supplied to the source device, over the interface, upon the request of the source device. The source device then chooses its output format, taking into account the format of the original video stream and the formats supported by the DTV Monitor. The source device (e.g., STB) is responsible for the format conversions necessary to supply video in an understandable form to the DTV Monitor.

This standard adds the DTM Monitor's ability to describe other capabilities in addition to supported video formats (e.g., digital audio). In those cases, the same basic mechanism applies (i.e., the source device reads EDID data in the DTV Monitor to determine its capabilities and then the source device only sends what the DTV Monitor can understand).

3.1 General Requirements

All systems mentioned above (DVI 1.0, Open LDI 0.95, etc.) require 640x480p (VGA) as base-level support. Therefore, any DTV Monitor complying with this standard shall support 640x480p [10]. Additionally, any DTV Monitor complying with this standard shall also support 720X480p or 720X576p in one of the two picture aspect ratios (4:3 or 16:9) as defined in Section 4.5 or Section 4.9. Additionally, any HDTV Monitor complying with this standard shall also support either 1920x1080i or 1280x720p (with a 16:9 picture aspect ratio) as defined in Sections 4.3 and 4.4 or Sections 4.7 and 4.8.³

³ Note that this implicitly allows any source device (intended to supply content to such a DTV Monitor) to only support 720X480p (720X576p for 50 Hz systems) or 640X480p. For the source device to be able to supply high definition content to any HDTV Monitor, it must be capable of supporting 1920x1080i and 1280x720p since the HDTV Monitor may support only one of the two formats. It implies that, in some cases, the source device (e.g., STB) would need to convert the video from the format at its input (e.g.,

Formats for 720X480i and 720X576i are also defined in this standard, and are optional. Since these formats were defined in 861 and 861A, the method used to list these formats in EDID can be similar to the method used for the 720X480p, 720X576p, 1920X1080i, and 1280X720p formats. 13 other basic timing formats have been defined in this version of the standard (861B). The method for listing these formats in EDID is new in 861B and will be described in Sections 7 and 7.5.

The physical/link standards in Annexes B & C do not support transport of closed captioning (EIA/CEA-608-B and EIA/CEA-708-B), therefore the source device must undertake any processing of these elements. Specifically, if closed captioning is to be displayed, it must be decoded by the source device, inserted into the video and displayed as open captions. Similarly, System Information, program information, events, service descriptors, etc., if they are displayed, must be graphical information inserted into the video by the source device. Control of closed captioning settings, programs, events, etc. are a feature of the source device, not supported by this interface and beyond the scope of this standard.

Furthermore, content advisory user menus, settings and blocking must be accommodated in the source device, and is beyond the scope of this standard.

Table 2 summarizes display requirements specified by this standard. Incorporated in the same table are recommendations for source devices. These recommendations are based on the CEA's Definitions for Digital Television Products [16]. In the table, the CEA term *tuner* refers to a device that decodes a digital video signal that has been modulated onto an RF carrier and outputs video. To comply with this standard a source device does not have to be a tuner.

720X480i) to one of the formats supported by the DTV over this interface (e.g., 720X480p). For additional guidance for source devices see Table 2 and Section 7.2.5.

Table 2. 861/861A Video Format Timing Requirements and their Relation to CEA Definitions

60 Hz Systems

CEA Definition	Video Format	EDTV Monitor (Display)	HDTV Monitor (Display)	EDTV Tuner (Source)	HDTV Tuner (Source)
SDTV	720x480i @ 60 Hz	o	o	o	o
EDTV	640x480p @ 60 Hz	X	X	✓ *	✓ *
EDTV	720x480p @ 60 Hz	X	X		
HDTV	1280x720p @ 60 Hz	o	X*	o	✓
HDTV	1920x1080i @ 60 Hz	o		o	✓

50 Hz Systems

CEA Definition	Video Format	EDTV Monitor (Display)	HDTV Monitor (Display)	EDTV Tuner (Source)	HDTV Tuner (Source)
SDTV	720x576i @ 50 Hz	o	o	o	o
EDTV	640x480p @ 60 Hz	X	X	✓ *	✓ *
EDTV	720x576p @ 50 Hz	X	X		
HDTV	1280x720p @ 50 Hz	o	X*	o	✓
HDTV	1920x1080i @ 50 Hz	o		o	✓

Legend

X	Required by this standard
X*	Either one of the two formats is required, the other is optional
✓	Recommended by this standard and implied by CEA DTV definitions
✓ *	Either one of the two formats is recommended, the other is optional
o	Optional

The formats in Table 3 are new in 861B and are optional for all CEA DTV definitions.

Table 3. New 861B Video Format Timings (all optional)

60 Hz Systems⁴	50Hz Systems	Film
720(1440)X240p @ 60 Hz	720(1440)X288p @ 50 Hz	1920X1080p @ 24 Hz
(2880)X480i @ 60 Hz	(2880)X576i @ 50 Hz	
(2880)X240p @ 60 Hz	(2880)X288p @ 50 Hz	
1440X480p @ 60 Hz	1440X576p @ 50 Hz	
1920X1080p @ 60 Hz	1920X1080p @ 50 Hz	
1920X1080p @ 30 Hz	1920X1080p @ 25 Hz	

⁴ Parentheses indicate instances where pixels are repeated to meet the minimum speed requirements of the interface. For example, in the 720X240p case, the pixels on each line are double-clocked. In the (2880)X480i case, the number of pixels on each line, and thus the number of times that they are repeated, is variable, and is sent to the DTV monitor by the source device.

4 VIDEO FORMATS AND WAVEFORM TIMINGS

Timing for the uncompressed digital video interface to the DTV Monitor shall support the base format of 640x480p @ 60 Hz.

For 50 Hz systems, the DTV Monitor shall support an additional video format timing of 720X576p @ 50 Hz in at least one of two picture aspect ratios, 4:3 or 16:9. For 60 Hz systems, the DTV Monitor shall support an additional video format timing of 720X480p @ 60 Hz in at least one of two picture aspect ratios, 4:3 or 16:9.

An HDTV Monitor shall support the timing requirements for 1280X720P, 1920X1080i, or both, at the frequency appropriate for its country, 50 Hz or 60 Hz.

The 720X576i @ 50 Hz and 720X480i @ 60 Hz formats are optional and were available in 861 and 861A. All of the formats listed in Table 3 are new and are optional.

To support the 720X480i, 720X576i, 720X240p or 720X288p video formats, the pixels are double clocked for each line to meet the minimum speed requirements of the interface. Thus, 720X480i is referred to as (1440)x480i in Table 4, 720X576i is referred to as (1440)x576i, 720X240p is referred to as (1440)X240p, and 720X288p is referred to as (1440)X288p. Additionally, the "2880" formats ((2880)X480i, (2880)X240p, (2880)X576i, and (2880)X288p) each represent a family of formats in which the pixels are repeated a number of times. The number of times that the pixel is repeated is sent to the DTV Monitor by the source device.

For 60 Hz systems, the DTV Monitor shall be capable of displaying either 59.94 or 60 Hz (frame rate for progressive scan and field rate for interlaced scan) for the formats that it supports. Therefore, the 59.94 Hz and 60 Hz versions of a video format timing shall be considered the same video format with slightly different pixel clocks.

The new 861B low-resolution progressive video format timings can consist of one of several frame formats (i.e., 1440X240p, 2880X240p, 1440X288p, and 2880X288p). These frame formats differ only by one or two scan lines in the vertical blanking interval. For that reason, they are treated as the same video format with a slight variation in the parameters (i.e., handled in a way similar to the 59.94Hz/60Hz formats). For this reason, if a DTV Monitor declares support of one of these video formats of a specific picture aspect ratio (through EDID), then it shall support all variations of that video format of the same picture aspect ratio. The mandatory and optional formats defined in this standard shall comply with the timing parameters in Table 4 and the timing diagrams that follow. DTV Monitors shall be able to accept video whose pixel clock is accurate to within 0.5% of the clock frequency shown in Table 4.

Table 4. Timing Parameters for the Uncompressed Digital Video Interface

Output Formats (~59.94 Hz)					(Hz)	(kHz)	(MHz)						
Format	V active	Int/Prog	Total Lines	V blanking ¹	V Freq	H Freq	Pixel Freq	H total	H active	H blanking	Aspect ²	Display ³	Reference
1	480	Prog	525	45	59.940	31.469	25.175	800	640	160	4x3	CRT/Dig	MTS [10]
2,3	480	Prog	525	45	59.940	31.469	27.000	858	720	138	4x3,16x9	CRT/Dig	770.2 [19]
4	720	Prog	750	30	59.939	44.955	74.175	1650	1280	370	16x9	Dig	770.3 [20]
5	1080	Int	1125	22.5	59.939	33.716	74.175	2200	1920	280	16x9	CRT	770.3 [20]
6,7	480	Int	525	22.5	59.940	15.734	27.000	1716 ⁴	1440 ⁴	276	4x3,16x9	CRT	770.2 [19]
8,9	240	Prog	262	22.0	60.054	15.734	27.000	1716 ⁴	1440 ⁴	276	4x3,16x9	CRT	770.2 [19]
8,9	240	Prog	263	23.0	59.826	15.734	27.000	1716 ⁴	1440 ⁴	276	4x3,16x9	CRT	770.2 [19]
10,11	480	Int	525	22.5	59.940	15.734	54.000	3432 ⁴	2880 ⁴	552	4x3,16x9	CRT	770.2 [19]
12,13	240	Prog	262	22.0	60.054	15.734	54.000	3432 ⁴	2880 ⁴	552	4x3,16x9	CRT	770.2 [19]
12,13	240	Prog	263	23.0	59.826	15.734	54.000	3432 ⁴	2880 ⁴	552	4x3,16x9	CRT	770.2 [19]
14,15	480	Prog	525	45	59.940	31.469	54.000	1716	1440	276	4x3,16x9	CRT/Dig	770.2 [19]
16	1080	Prog	1125	45	59.939	67.432	148.350	2200	1920	280	16x9	Dig	
Output Formats (~60 Hz) ⁵					(Hz)	(kHz)	(MHz)						
Format	V active	Int/Prog	Total Lines	V blanking ¹	V Freq	H Freq	Pixel Freq	H total	H active	H blanking	Aspect ²	Display ³	Reference
1	480	Prog	525	45	60.000	31.500	25.200	800	640	160	4x3	CRT/Dig	MTS [10]
2,3	480	Prog	525	45	60.000	31.500	27.027	858	720	138	4x3,16x9	CRT/Dig	770.2 [19]
4	720	Prog	750	30	60.000	45.000	74.250	1650	1280	370	16x9	Dig	770.3 [20]
5	1080	Int	1125	22.5	60.000	33.750	74.250	2200	1920	280	16x9	CRT	770.3 [20]
6,7	480	Int	525	22.5	60.000	15.750	27.027	1716 ⁴	1440 ⁴	276	4x3,16x9	CRT	770.2 [19]
8,9	240	Prog	262	22.0	60.115	15.750	27.027	1716 ⁴	1440 ⁴	276	4x3,16x9	CRT	770.2 [19]
8,9	240	Prog	263	23.0	59.886	15.750	27.027	1716 ⁴	1440 ⁴	276	4x3,16x9	CRT	770.2 [19]
10,11	480	Int	525	22.5	60.000	15.750	54.054	3432 ⁴	2880 ⁴	552	4x3,16x9	CRT	770.2 [19]
12,13	240	Prog	262	22.0	60.115	15.750	54.054	3432 ⁴	2880 ⁴	552	4x3,16x9	CRT	770.2 [19]
12,13	240	Prog	263	23.0	59.886	15.750	54.054	3432 ⁴	2880 ⁴	552	4x3,16x9	CRT	770.2 [19]
14,15	480	Prog	525	45	60.000	31.500	54.054	1716	1440	276	4x3,16x9	CRT/Dig	770.2 [19]
16	1080	Prog	1125	45	60.000	67.500	148.500	2200	1920	280	16x9	Dig	
Output Formats (~50 Hz)					(Hz)	(kHz)	(MHz)						
Format	V active	Int/Prog	Total Lines	V blanking ¹	V Freq	H Freq	Pixel Freq	H total	H active	H blanking	Aspect ²	Display ³	Reference
17,18	576	Prog	625	49	50.000	31.250	27.000	864	720	144	4x3,16x9	CRT/Dig	BT1358[31]
19	720	Prog	750	30	50.000	37.500	74.250	1980	1280	700	16x9	Dig	296M[14]
20	1080	Int	1125	22.5	50.000	28.125	74.250	2640	1920	720	16x9	CRT	274M[12]
21,22	576	Int	625	24.5	50.000	15.625	27.000	1728 ⁴	1440 ⁴	276	4x3,16x9	CRT	BT656-4[33]
23,24	288	Prog	312	24.0	50.080	15.625	27.000	1728 ⁴	1440 ⁴	276	4x3,16x9	CRT	BT656-4[33]
23,24	288	Prog	313	25.0	49.920	15.625	27.000	1728 ⁴	1440 ⁴	276	4x3,16x9	CRT	BT656-4[33]
23,24	288	Prog	314	26.0	49.761	15.625	27.000	1728 ⁴	1440 ⁴	276	4x3,16x9	CRT	BT656-4[33]
25,26	576	Int	625	24.5	50.000	15.625	54.000	3456 ⁴	2880 ⁴	552	4x3,16x9	CRT	BT656-4[33]
27,28	288	Prog	312	24.0	50.080	15.625	54.000	3456 ⁴	2880 ⁴	552	4x3,16x9	CRT	BT656-4[33]
27,28	288	Prog	313	25.0	49.920	15.625	54.000	3456 ⁴	2880 ⁴	552	4x3,16x9	CRT	BT656-4[33]
27,28	288	Prog	314	26.0	49.761	15.625	54.000	3456 ⁴	2880 ⁴	552	4x3,16x9	CRT	BT656-4[33]
29,30	576	Prog	625	49	50.000	31.250	54.000	1728	1440	288	4x3,16x9	CRT/Dig	BT1358[31]
31	1080	Prog	1125	45	50.000	56.250	148.500	2640	1920	720	16x9	Dig	274M[12]
Output Formats (~23.97, 24, 25, 29.97, 30 Hz)													
Format	V active	Int/Prog	Total Lines	V blanking ¹	V Freq	H Freq	Pixel Freq	H total	H active	H blanking	Aspect ²	Display ³	Reference
32	1080	Prog	1125	45	23.976	26.973	74.175	2750	1920	830	16x9	CRT/Dig	274M[12]
32	1080	Prog	1125	45	24.000	27.000	74.250	2750	1920	830	16x9	CRT/Dig	274M[12]
33	1080	Prog	1125	45	25.000	28.125	74.250	2640	1920	720	16x9	CRT/Dig	274M[12]
34	1080	Prog	1125	45	29.970	33.716	74.175	2200	1920	280	16x9	CRT/Dig	274M[12]
34	1080	Prog	1125	45	30.000	33.750	74.250	2200	1920	280	16x9	CRT/Dig	274M[12]

Table 4 Notes

¹V blanking Note: fractional values indicate that the number of blanking lines varies (see timing diagram for more details).

²Picture Aspect Ratio Note: the display will state what picture aspect ratios it supports for a given format, and the source can choose how to support it. For example, with the 720X480 (16x9) data format and a 4x3 display, the source could (1) use pan and scan information to crop the data to 540 horizontal pixels and then resample up to the required 720 pixels for output to the display or (2) vertically resample to 360 lines and create bars of 60 lines above and below it to send this "letterbox" with the required 480 lines for output. Other picture scaling methods are possible in either source device or DTV Monitor. For example, picture aspect ratio scaling (picture expand, shrink, etc.) can be accomplished in the source device, including, possibly, added black/gray lines in the addressable pixel portion of the video. The exception to this is the 640x480 format, which is always sent as 4x3 data, and it is up to the display to determine how it wants to display it.

³Display Note: this category is not exclusive, but merely states the main target, Cathode Ray Tubes or Digital Displays.

⁴480i, 240p, 576i, and 288p Note: the pixels for the 720xN formats (where N is the number of lines) are double clocked for each line to meet minimum speed requirements of the interface, thus H active is shown as 1440, instead of 720. Each pixel of the 2880xN formats is repeated a variable number of times. The repeat value is communicated using the AVI InfoFrames (see Section 6.1.3).

⁵Format Note: For 60 Hz formats, the display will respond automatically to either 60 Hz or 59.94 Hz (same format with slightly different clocks). The 25.2 MHz pixel frequency value is within the +/-0.5% (allowed in the VESA MTS [10]) of 25.175 MHz. The 480p formats and the 480i formats are typically 59.94 Hz, and the HDTV formats are typically 60 Hz.

4.1 Aspect Ratio

The 480p, 480i, 240p, 576p, 576i, and 288p formats are available in two different aspect ratios (4:3 and 16:9). Video formats with different picture aspect ratios are considered different formats that can be independently supported and discovered.

As can be seen in the timing diagrams, there is no difference in the timing parameters for video formats that have different picture aspect ratios but are otherwise the same (e.g., 720X480p). For a display device to simultaneously support both formats, the source device needs a way to let the display device know the picture aspect ratio in which the video should be displayed. When EIA/CEA-861 was published, methods to indicate Picture Aspect Ratio were not defined and the recommendation was that the DTV Monitor should list only one picture aspect ratio of 720X480p and only one picture aspect ratio of 720X480i in the E-EDID structure at any given time and the signal shall be processed accordingly. For this standard, it is now mandatory that a DTV Monitor list only one picture aspect ratio of 720X480p (720X576p for 50 Hz countries) and only one picture aspect ratio of 720X480i (720X576i for 50 Hz countries) at a time unless it is capable of receiving and decoding the AVI defined in Section 6. Many of the new formats (e.g., 720X240p, (2880)X240p, (2880)X480i, 1440X480p, etc.) are also available in two different picture aspect ratios. However, if any of these formats are supported in the DTV Monitor, then it is required that CEA EDID Timing Extension Version 3 be used in the EDID data structure (see Section 7.1.3). This implies that these formats will not be supported in implementations that do not also support reception of the AVI InfoFrame Version 2.

It was possible for a DTV Monitor compliant with EIA/CEA-861 to support both aspect ratios of the 720X480 formats as a user programmable option on the DTV Monitor. In that case, the EDID 18-byte detailed timing descriptor could be modified to reflect the proper picture aspect ratio. It is recommended that source devices (e.g., STB) periodically reread the EDID information.

The effects on the EDID data structure as well as backward compatibility to 861 devices are explained in Section 7.2.4.

4.2 640x480p @59.94/60 Hz (Format 1)

This timing is based on the timing in *VESA Monitor Timings Specification*, version 1.0 revision 0.8 [10]. The only difference is where VESA defines blanking as not including the border while this document includes the border within the blanking interval. Unlike the other formats, PC quantization levels (i.e., 256 levels in the case of RGB) are used for this format.

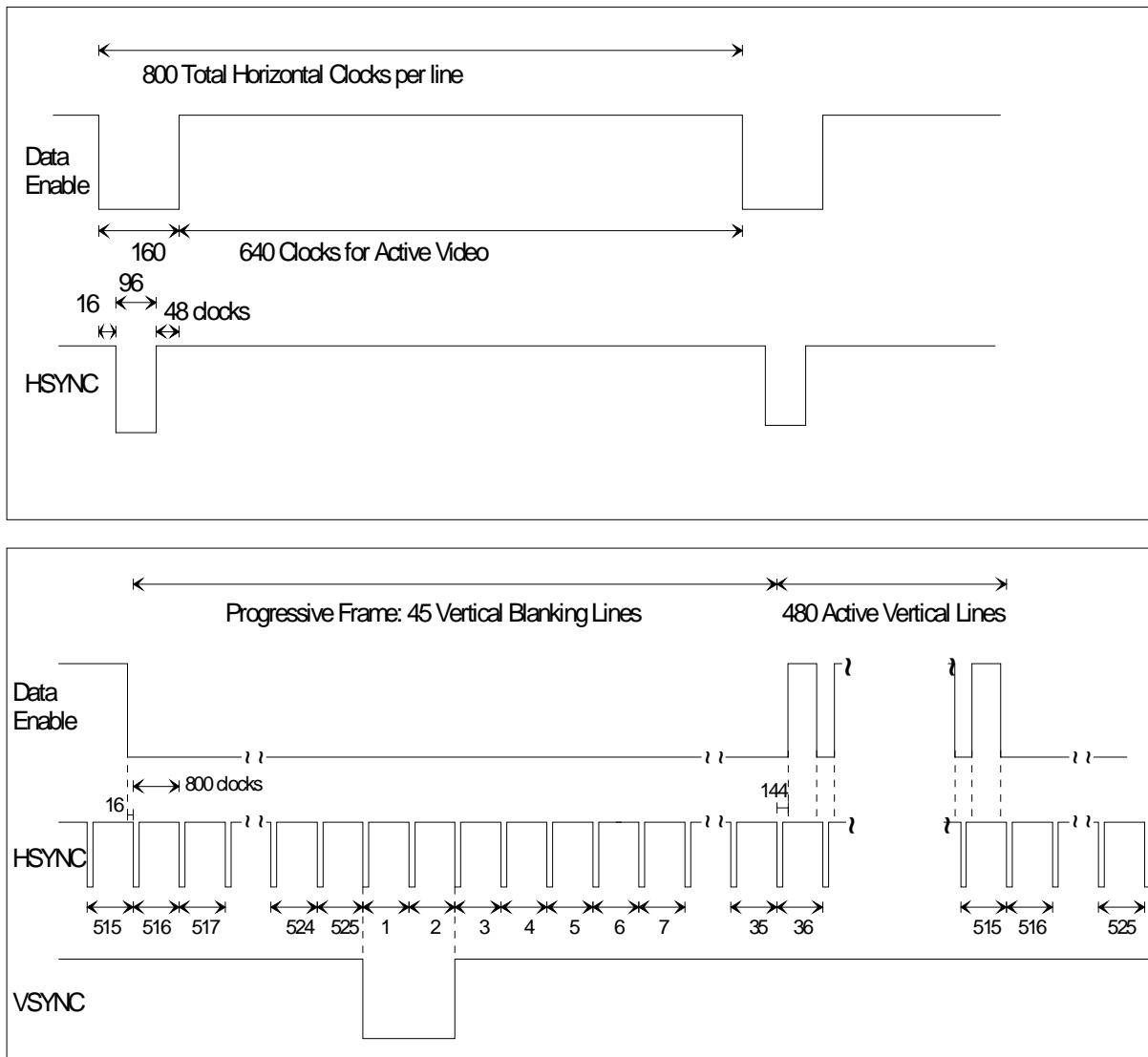

Figure 2. Timing parameters for 640x480p @ 59.94/60 Hz.

4.3 1280x720p @59.94/60 Hz (Format 4)

This timing is based on EIA/CEA-770.3-C [20], but there are two differences. First, EIA/CEA-770.3-C uses tri-level sync, while this document uses bi-level. Bi-level sync timing is accomplished using the second half of the EIA/CEA-770.3-C tri-level sync, defining the actual sync time to be the rising edge of that pulse.

Second, EIA/CEA-770.3-C uses a composite sync while this document uses separate sync signals, thus eliminating the need for serrations during vertical sync.

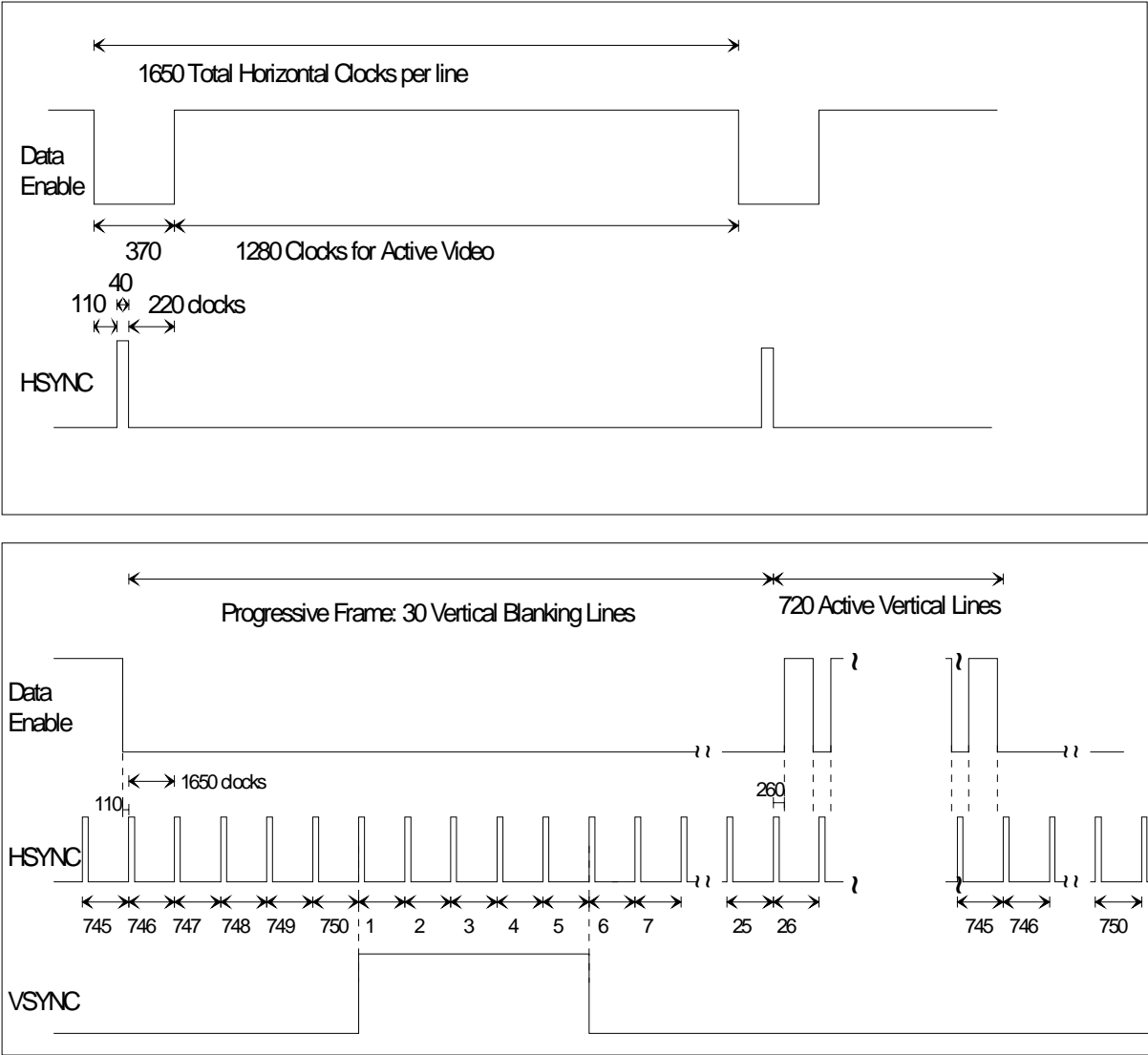

Figure 3. Timing parameters for 1280x720p @ 59.94/60 Hz.

4.4 1920x1080i @59.94/60 Hz (Format 5)

This timing is based on EIA/CEA-770.3-C [20], but there are two differences: First, EIA/CEA-770.3-C uses tri-level sync, while this document uses bi-level. Bi-level sync timing is accomplished using the second half of the EIA/CEA-770.3-C tri-level sync, defining the actual sync time to be the rising edge of that pulse.

Second, EIA/CEA-770.3-C uses a composite sync while this document uses separate sync signals, thus eliminating the need for serrations during vertical sync.

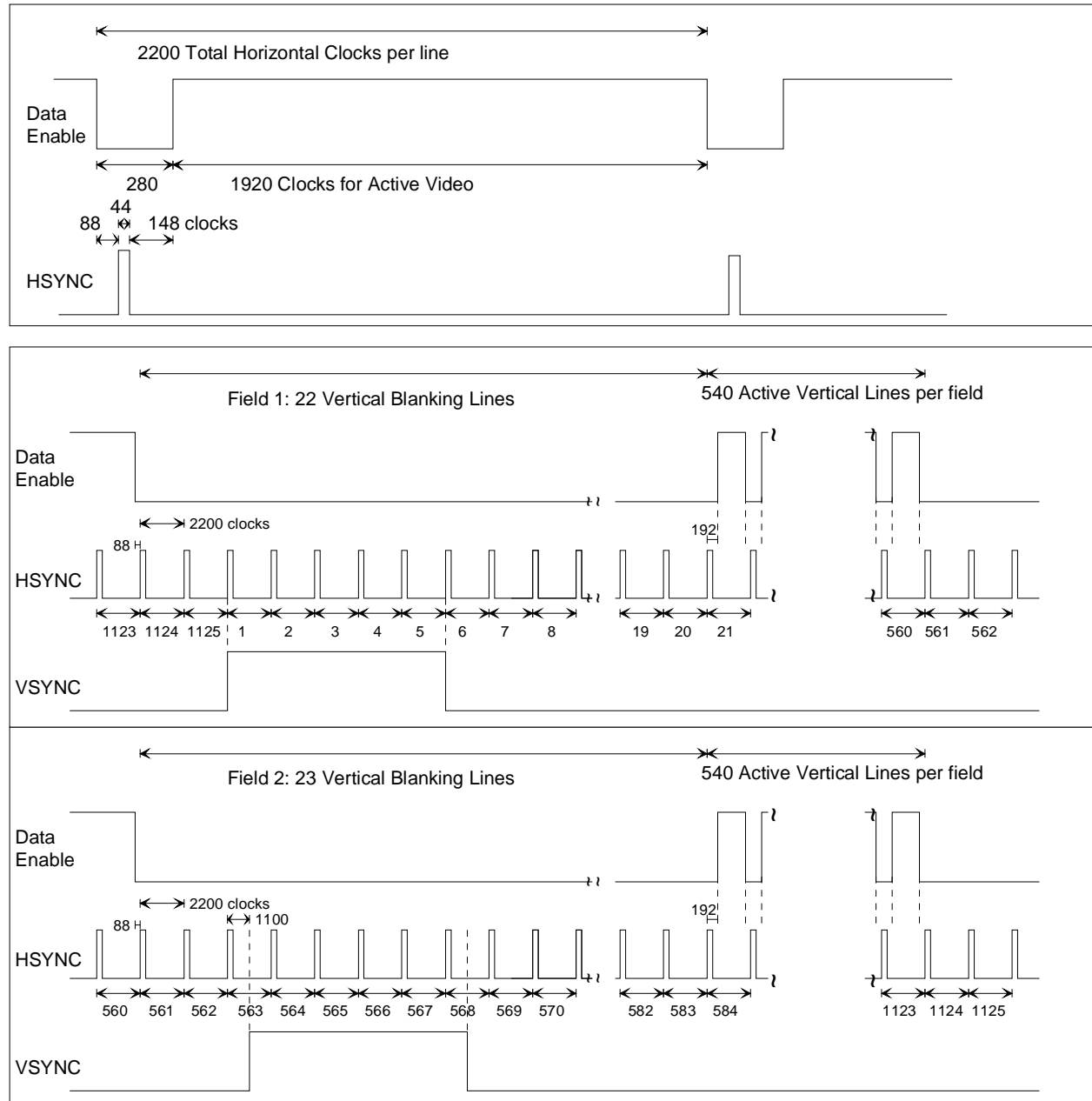

Figure 4. Timing parameters for 1920x1080i @ 59.94/60 Hz.

4.5 720x480p @59.94/60 Hz (Formats 2 & 3)

This timing is based on EIA/CEA-770.2-C [19], with one difference. EIA/CEA-770.2-C has a composite sync while this document uses separate sync signals, thus eliminating the need for serrations during vertical sync. This format timing can use either 4:3 or 16:9 aspect ratio. The DTV Monitor tells the source device, through the EDID structure, which formats it supports. The source device then formats the picture and scales the horizontal resolution for proper display.

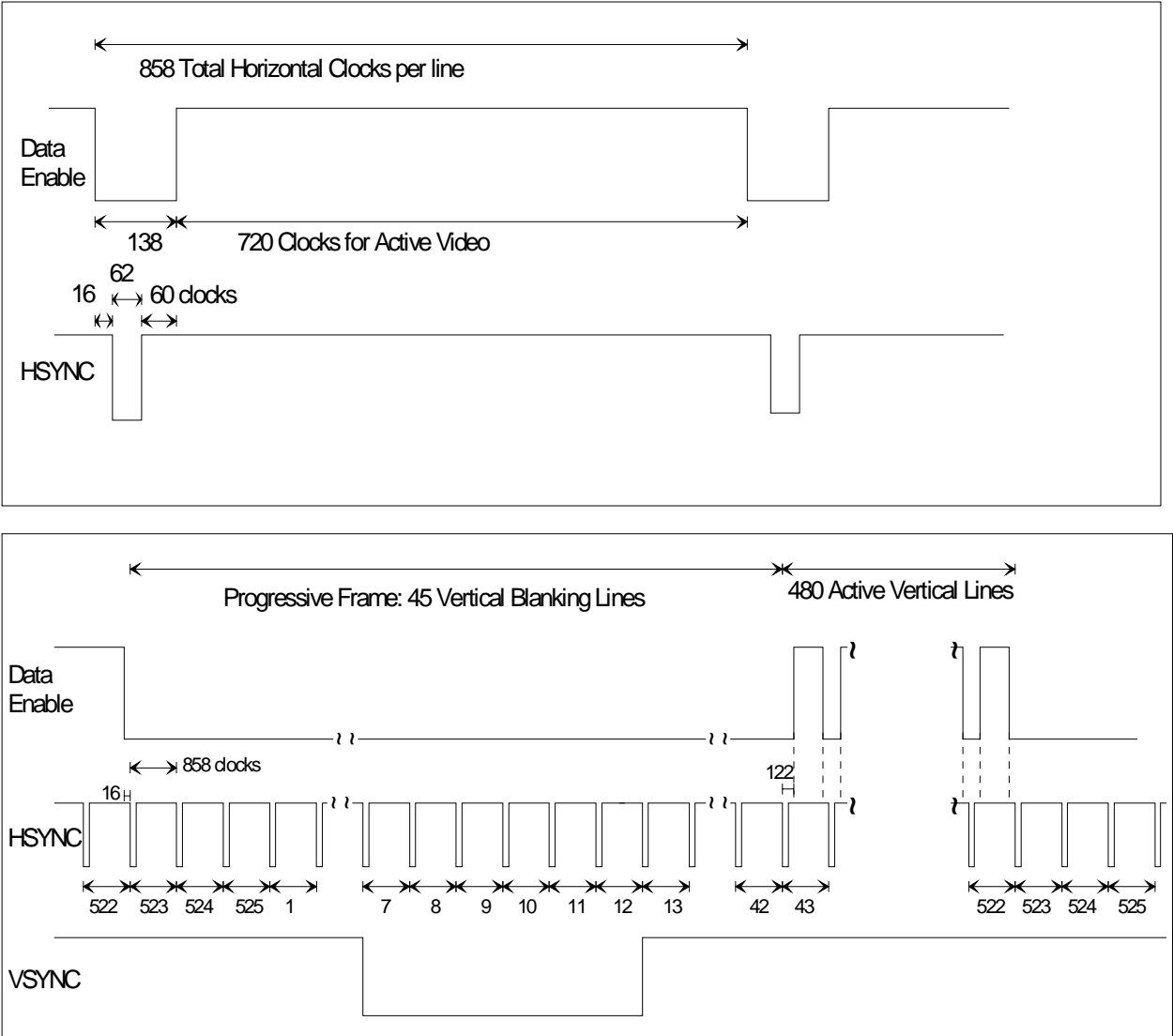

Figure 5. Timing parameters for 720x480p @ 59.94/60 Hz.

4.6 720(1440)x480i @59.94/60 Hz (Formats 6 & 7)

This timing is based on EIA/CEA-770.2-C [19], with a few differences. EIA/CEA-770.2-C has a composite sync while this document uses separate sync signals, thus eliminating the need for serrations during vertical sync. This format also assumes the pixels are double clocked to meet minimum clock speed requirements for the interface. This format timing can use either 4:3 or 16:9 aspect ratio. The DTV Monitor tells the source device, through the EDID structure, which formats it supports. The source device then formats the picture and scales the horizontal resolution for proper display.

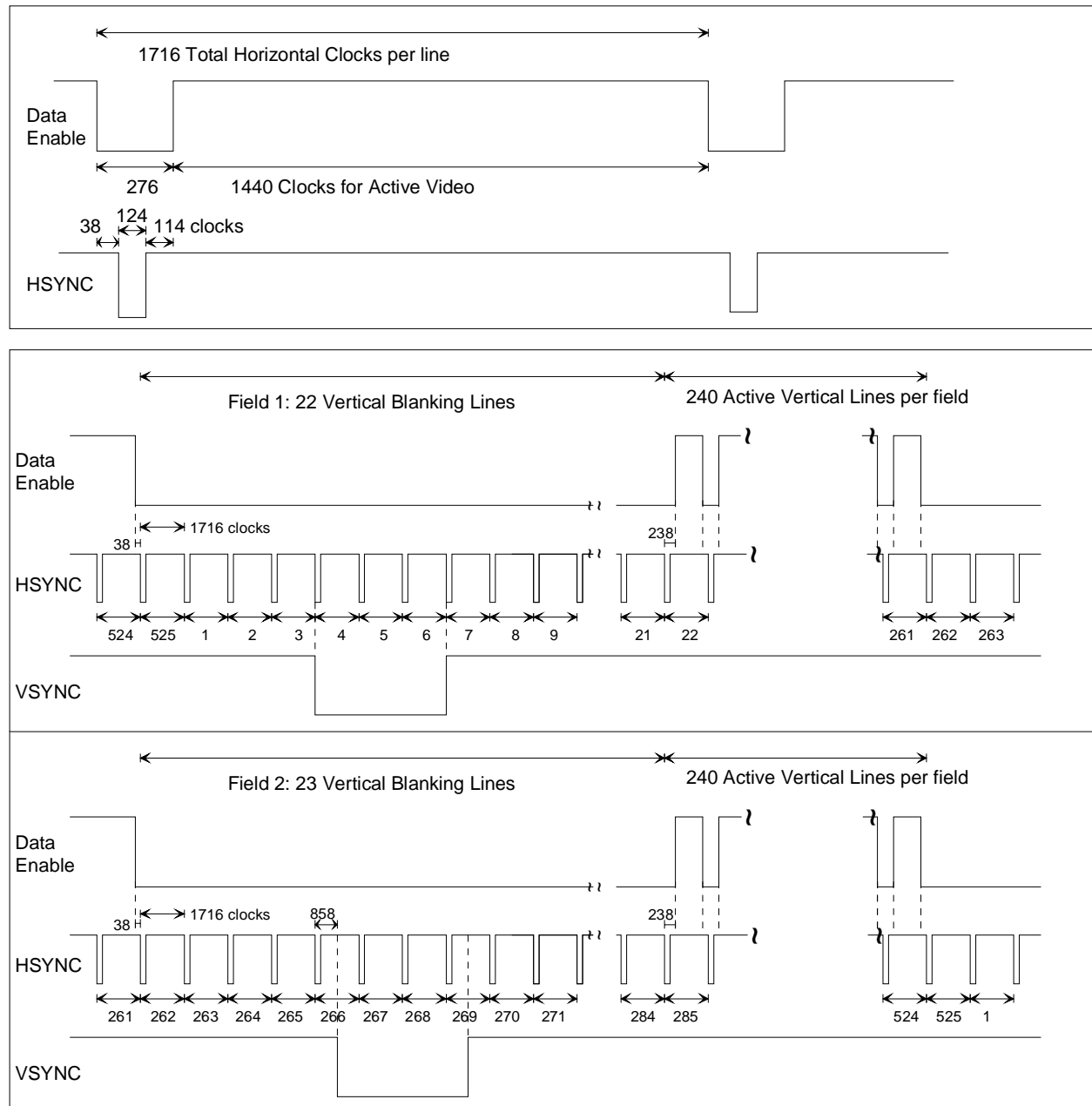

Figure 6. Timing Parameters for 720(1440)X480i @ 59.94/60 Hz.

4.7 1280X720p @ 50 Hz (Format 19)

This timing is based on SMPTE 296M [14], but there are two differences. First, SMPTE 296M uses tri-level sync, while this document uses bi-level. Bi-level sync timing is accomplished using the second half of the SMPTE 296M tri-level sync, defining the actual sync time to be the rising edge of that pulse.

Second, SMPTE 296M uses a composite sync while this document uses separate sync signals, thus eliminating the need for serrations during vertical sync.

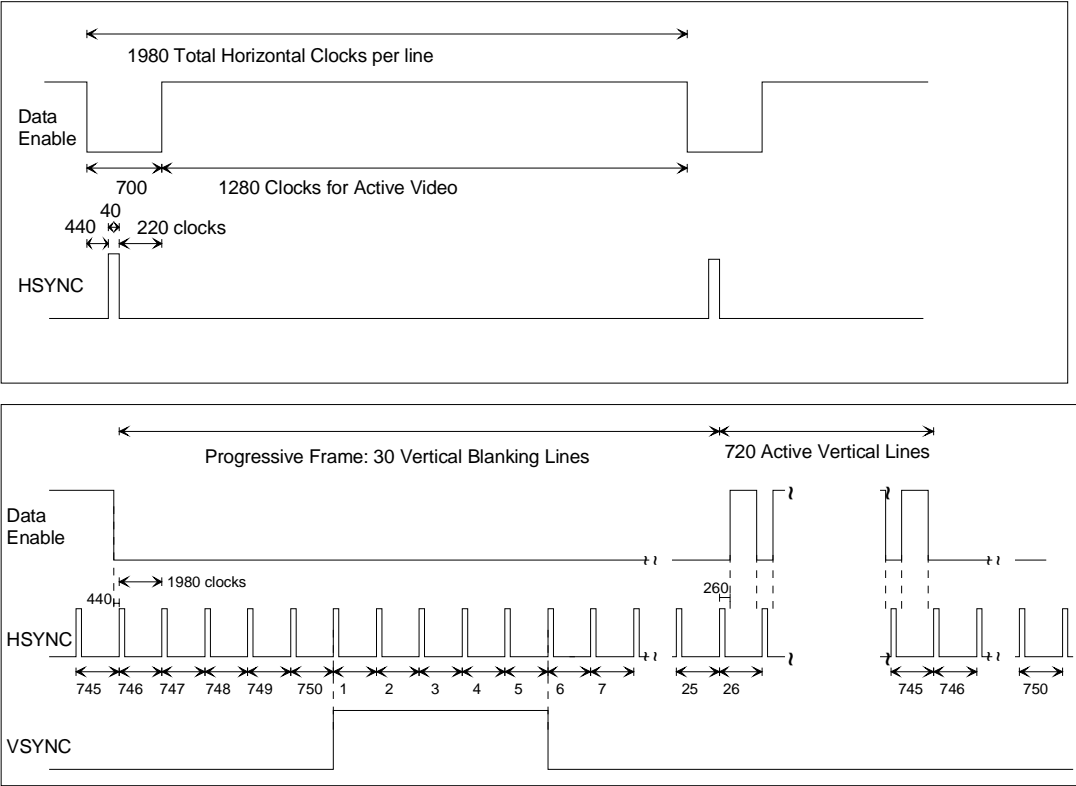

Figure 7. Timing parameters for 1280x720p @ 50 Hz.

4.8 1920X1080i @ 50 Hz (Format 20)

This timing is based on SMPTE 274M [12], but there are two differences: First, SMPTE 274M uses tri-level sync, while this document uses bi-level. Bi-level sync timing is accomplished using the second half of the SMPTE 274M tri-level sync, defining the actual sync time to be the rising edge of that pulse.

Second, SMPTE 274M uses a composite sync while this document uses separate sync signals, thus eliminating the need for serrations during vertical sync.

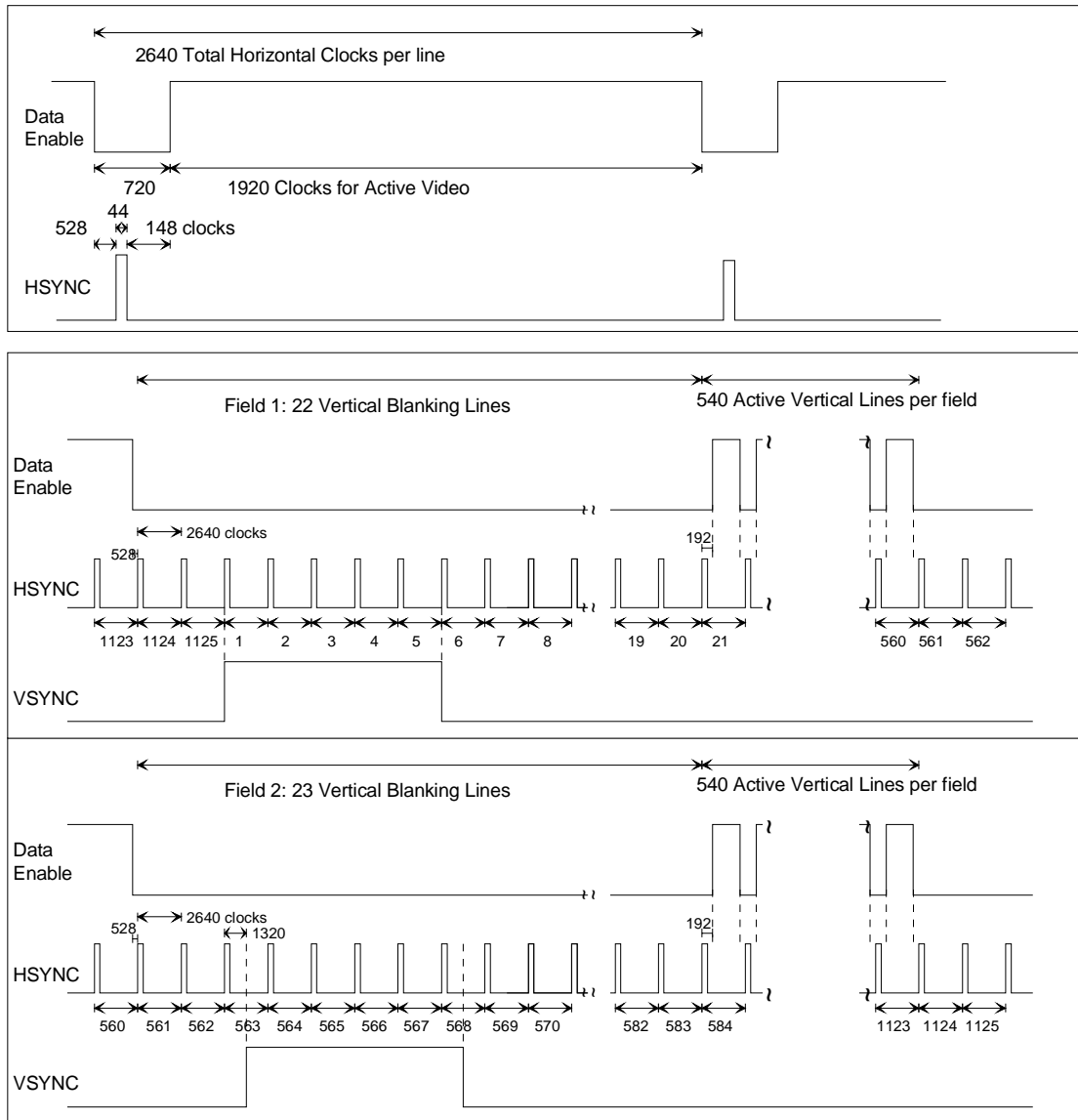

Figure 8. Timing parameters for 1920x1080i @ 50 Hz.

4.9 720X576p @ 50 Hz (Formats 17 & 18)

This timing is based on ITU-R BT.1358 [31]. This format timing can use either 4:3 or 16:9 aspect ratio. The DTV tells the Video Source, through the EDID structure, which formats it supports. The Video Source then formats the picture and scales the horizontal resolution for proper display.

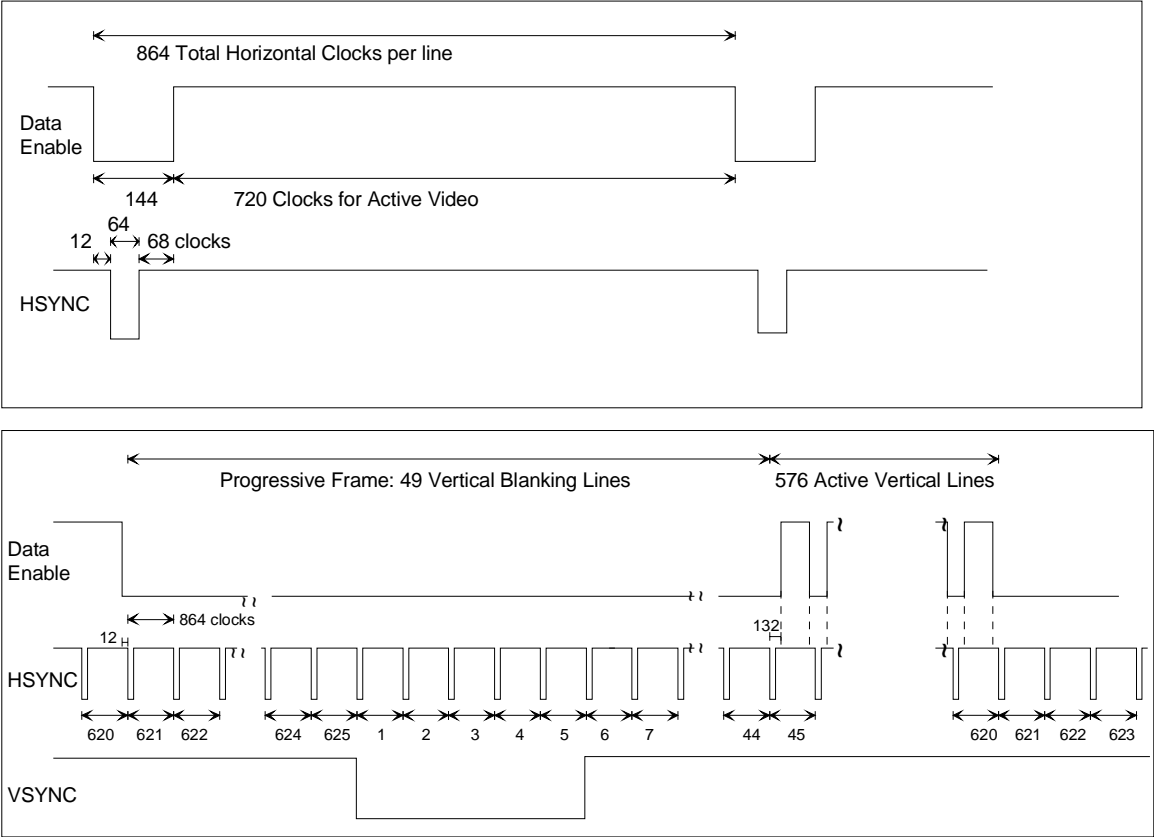

Figure 9. Timing parameters for 720x576p @ 50 Hz.

4.10 720(1440)X576i @ 50 Hz (Formats 21 & 22)

This timing is based on ITU-R BT.656-4 [33] except for horizontal and vertical synchronization pulse durations, which are specified in ITU-R BT.711-1 [34] and ITU-R BT.470-6 [32]. This format assumes the pixels are double clocked to meet minimum clock speed requirements for the interface. Thus, the clock is 27 MHz. This format timing can use either 4:3 or 16:9 aspect ratio. The DTV Monitor tells the Video Source, through the EDID structure, which formats it supports. The Video Source then formats the picture and scales the horizontal resolution for proper display.

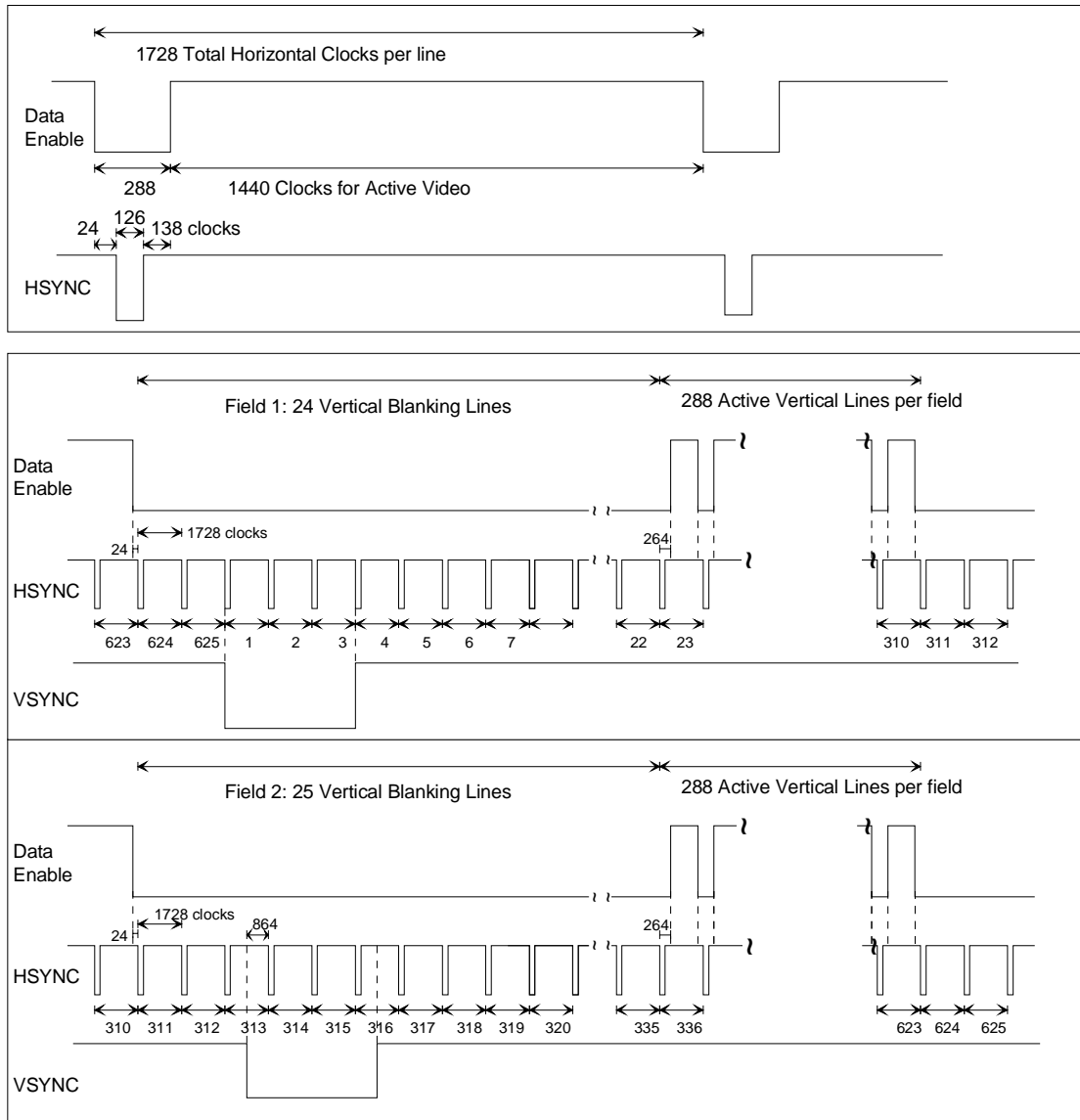

Figure 10. Timing Parameters for 720(1440)x576i @ 50 Hz

4.11 720(1440)X240p @ 59.94/60 Hz (Formats 8 & 9)

This format assumes the pixels are double clocked to meet minimum clock speed requirements for the interface. There are two possible frame formats that differ only in the number of lines in the vertical blanking interval of the frame. Both are considered variations of the same format. This format timing can use either 4:3 or 16:9 aspect ratio. The DTV Monitor tells the source device through the EDID structure, which formats it supports. The source device then formats the picture and scales the horizontal resolution for the proper display. Designers should be aware that this format was not defined at the time when EIA/CEA-861 was published. Therefore, an 861 type source box will probably not recognize this format in an 18-byte detailed timing descriptor.

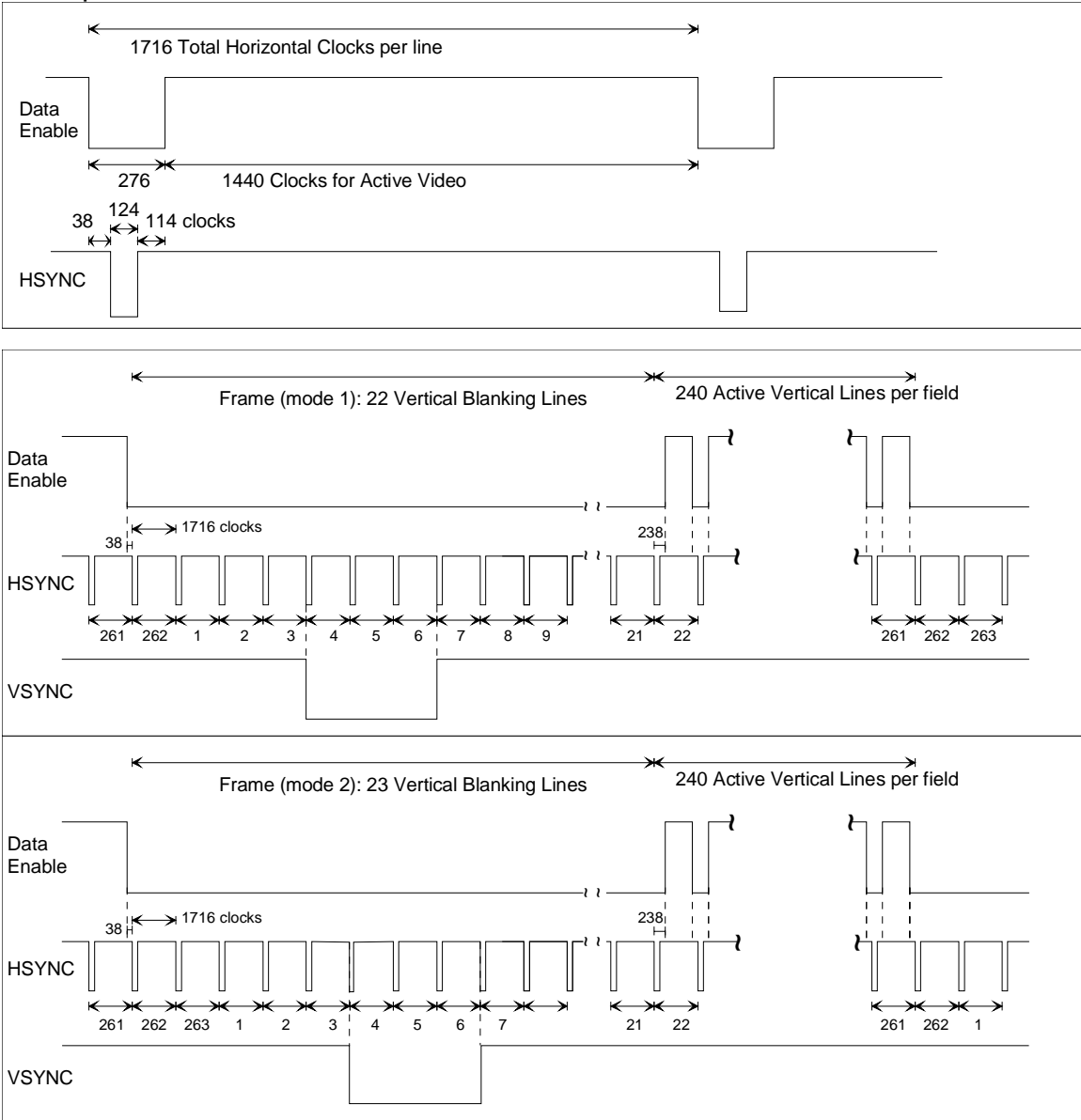

Figure 11. Timing Parameters for 720(1440)X240p @ 59.94/60 Hz.

4.12 (2880)X480i @ 59.94/60 Hz (Formats 10 & 11)

This format is a superset of a variety of video formats used in various game consoles. This format is unique in that, depending upon the pixel repetition factor specified in the AVI InfoFrame, this format can represent any of the following typical formats:

- $2880/10=288$ pixels/line
- $2880/8=360$ pixels/line
- $2880/7=411$ pixels/line
- $2880/5=576$ pixels/line
- $2880/4=720$ pixels/line

The pixel repetition factor is specified in the AVI. The DTV Monitor indicates it can accept any of the formats implied by this format superset through EDID.

This format will also typically have bars on the left and right sides. These bars will be $160/n$ pixels wide where n is the repetition factor.

This format timing can use either 4:3 or 16:9 aspect ratio. The DTV Monitor tells the source device through the EDID structure, which formats it supports. The source device then formats the picture and scales the horizontal resolution for the proper display.

Designers should be aware that this format was not defined at the time when EIA/CEA-861 was published. Because of the repetition factor, this format cannot be used in legacy 861/861A implementations.

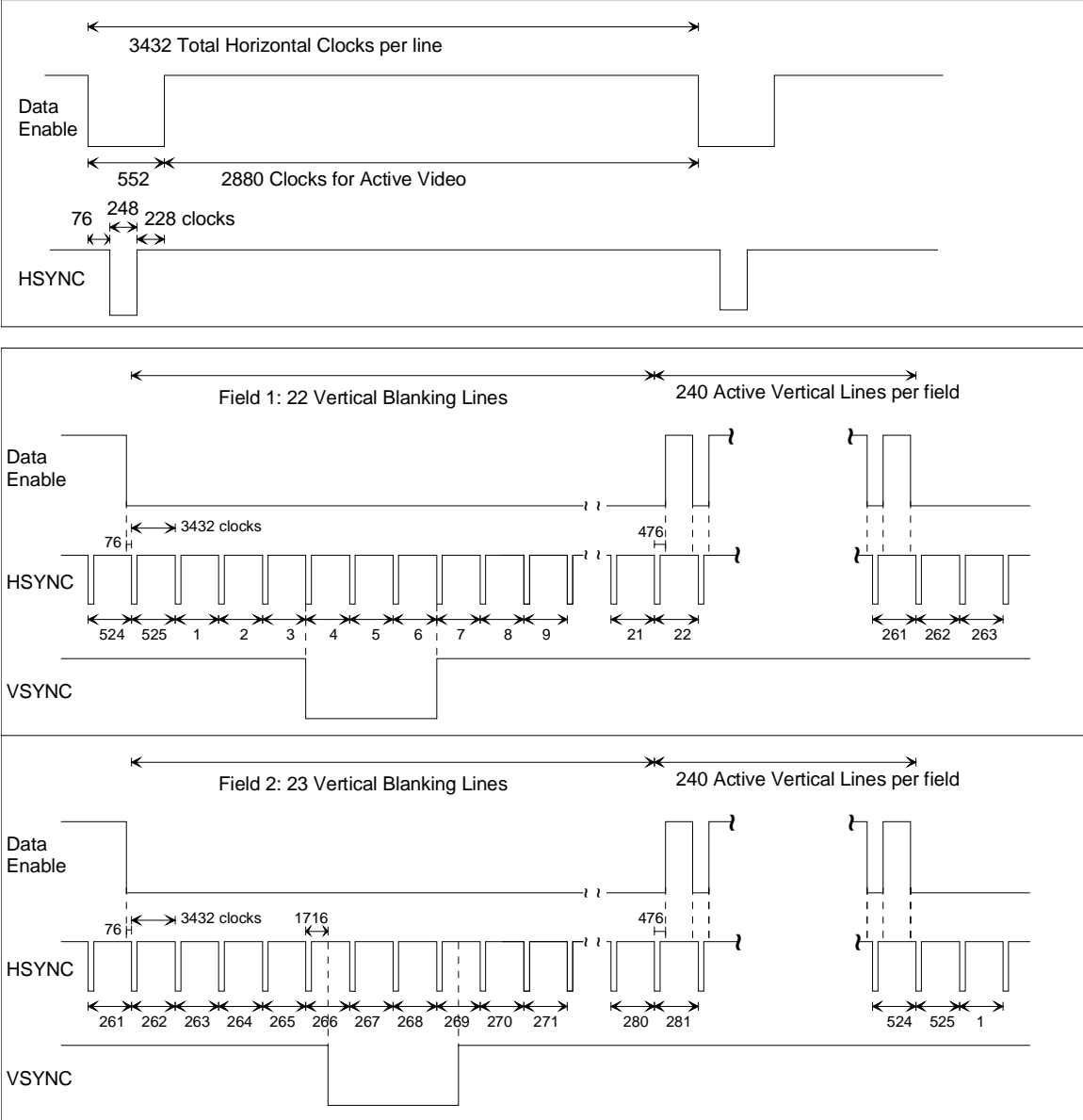

Figure 12. Timing Parameters for (2880)X480i @ 59.94/60 Hz.

4.13 (2880)X240p @ 59.94/60 Hz (Formats 12 & 13)

This format is a superset of a variety of video formats used in various game consoles. This format is unique in that, depending upon the pixel repetition factor specified in the AVI InfoFrame, this format can represent any of the following typical formats:

- 2880/10=288 pixels/line
- 2880/8=360 pixels/line
- 2880/7=411 pixels/line
- 2880/5=576 pixels/line
- 2880/4=720 pixels/line

The pixel repetition factor is specified in the AVI. The DTV Monitor indicates it can accept any of the formats implied by this format superset through EDID.

This format will also typically have bars on the left and right sides. These bars will be $160/n$ pixels wide where n is the repetition factor.

There are two possible frame formats that differ only in the number of lines in the vertical blanking interval of the frame. Both are considered variations of the same format.

This format timing can use either 4:3 or 16:9 aspect ratio. The DTV Monitor tells the source device through the EDID structure, which formats it supports. The source device then formats the picture and scales the horizontal resolution for the proper display.

Designers should be aware that this format was not defined at the time when EIA/CEA-861 was published. Because of the repetition factor, this format cannot be used in legacy 861 implementations.

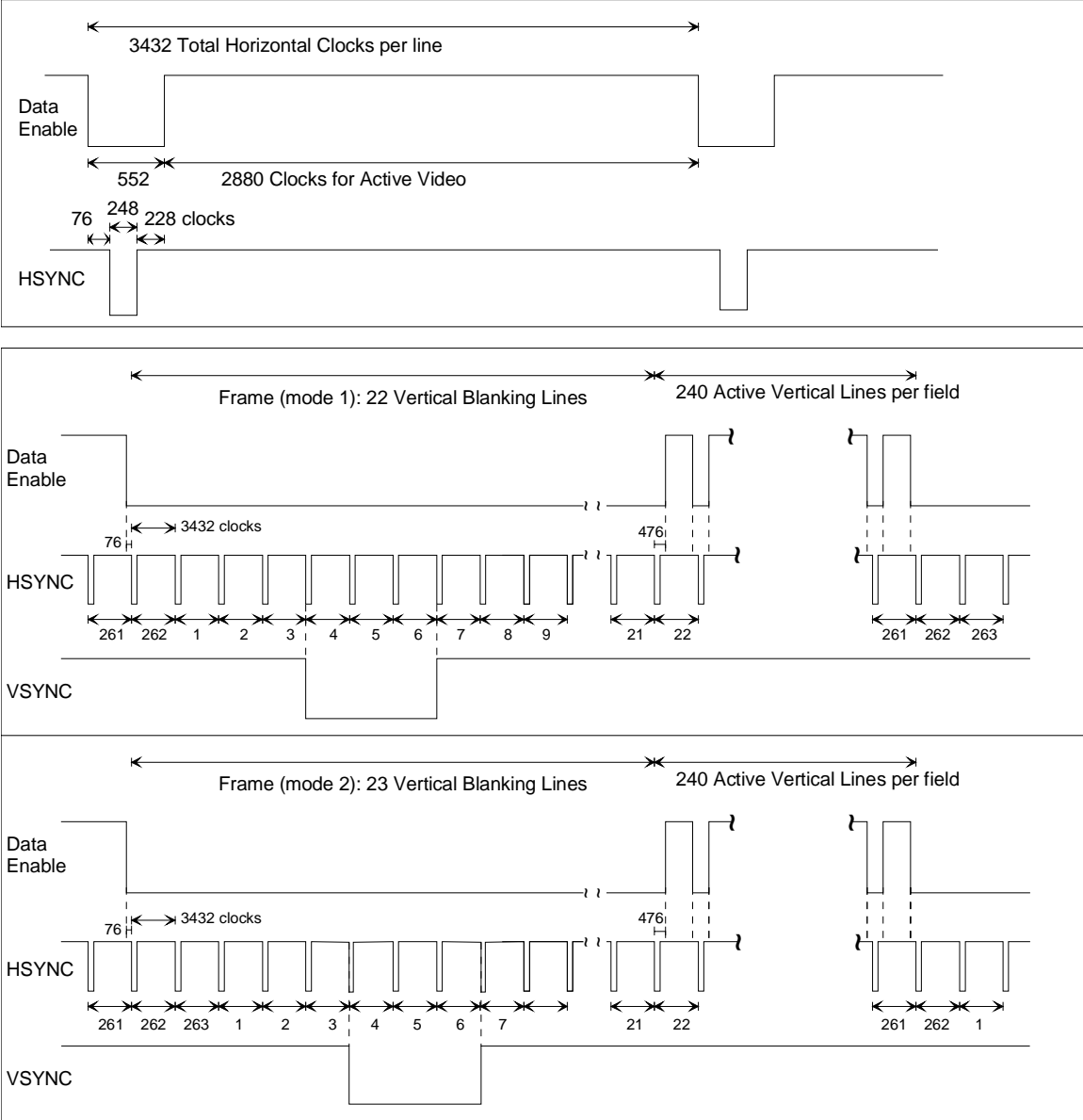

Figure 13. Timing Parameters for (2880)X240p @ 59.94/60 Hz.

4.14 1440X480p @ 59.94/60 Hz (Formats 14 & 15)

This format is for high-end DVD Players. It can use either 4:3 or 16:9 aspect ratio. The DTV Monitor tells the source device through the EDID structure, which formats it supports. The source device then formats the picture and scales the horizontal resolution for the proper display. Designers should be aware that this format was not defined at the time when EIA/CEA-861 was published. Therefore, an 861 type source box will probably not recognize this format in an 18-byte detailed timing descriptor.

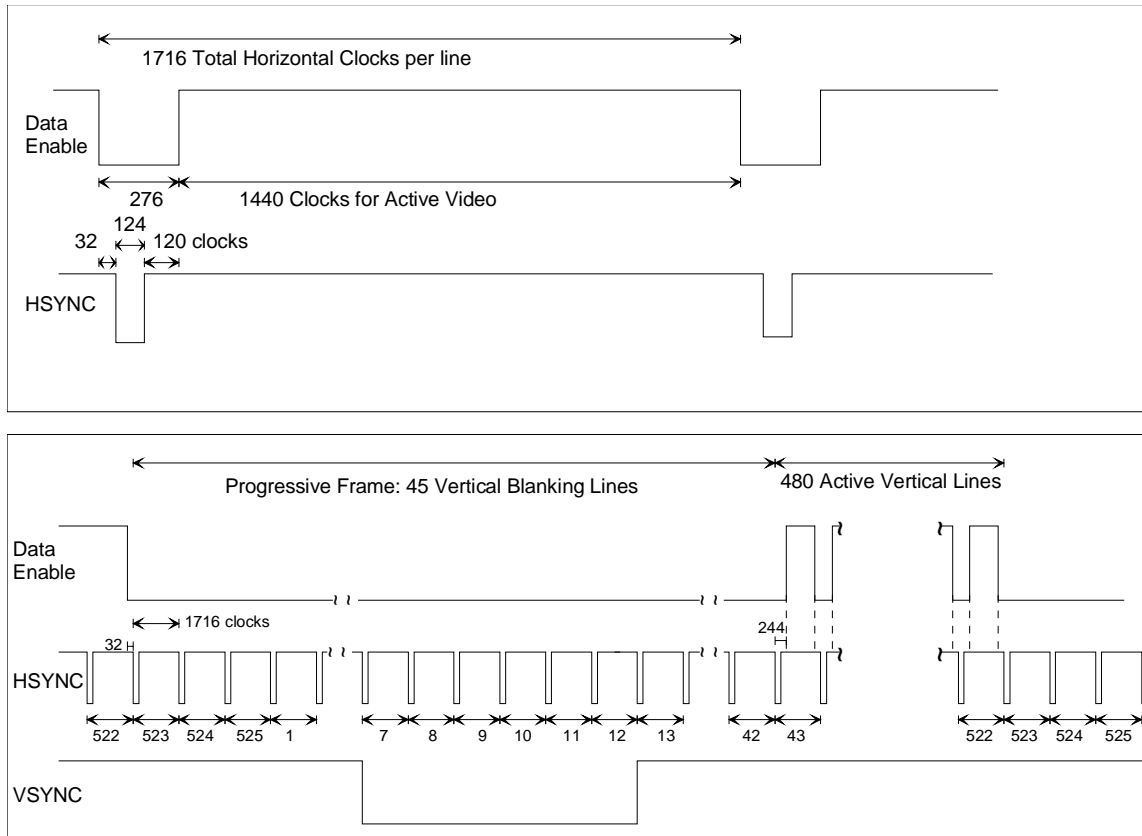

Figure 14. Timing Parameters for 1440X480p @ 59.94/60 Hz.

4.15 1920X1080p @ 59.94/60Hz (Format 16)

This format is available only in a 16:9 aspect ratio. Designers should be aware that this format was not defined at the time when EIA/CEA-861 was published. Therefore, an 861 type source box will probably not recognize this format in an 18-byte detailed timing descriptor.

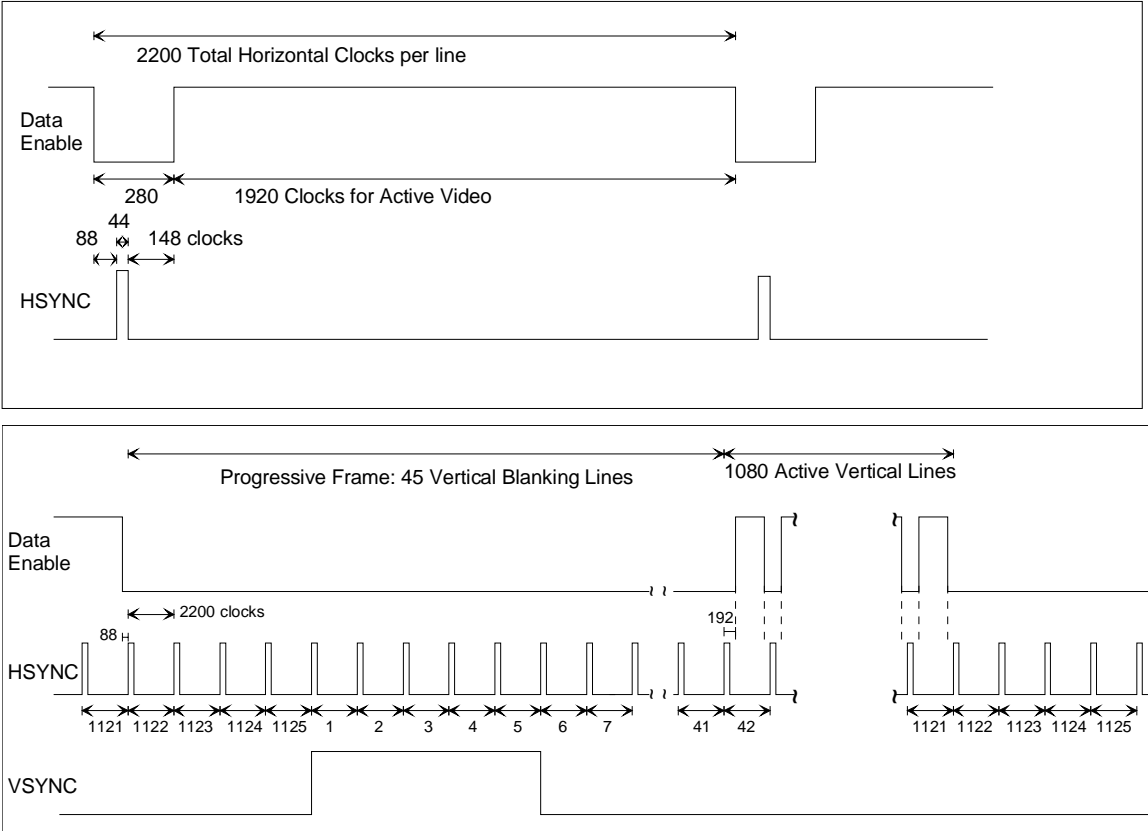

Figure 15. Timing Parameters for 1920X1080p @ 59.94/60 Hz.

4.16 720(1440)X288p @ 50 Hz (Formats 23 & 24)

This format assumes the pixels are double clocked to meet minimum clock speed requirements for the interface. There are three possible frame formats that differ only in the number of lines in the vertical blanking interval of the frame. All three are considered variations of the same format.

This format timing can use either 4:3 or 16:9 aspect ratio. The DTV Monitor tells the source device through the EDID structure, which formats it supports. The source device then formats the picture and scales the horizontal resolution for the proper display. Designers should be aware that this format was not defined at the time when EIA/CEA-861 was published. Therefore, an 861 type source box will probably not recognize this format in an 18-byte detailed timing descriptor.

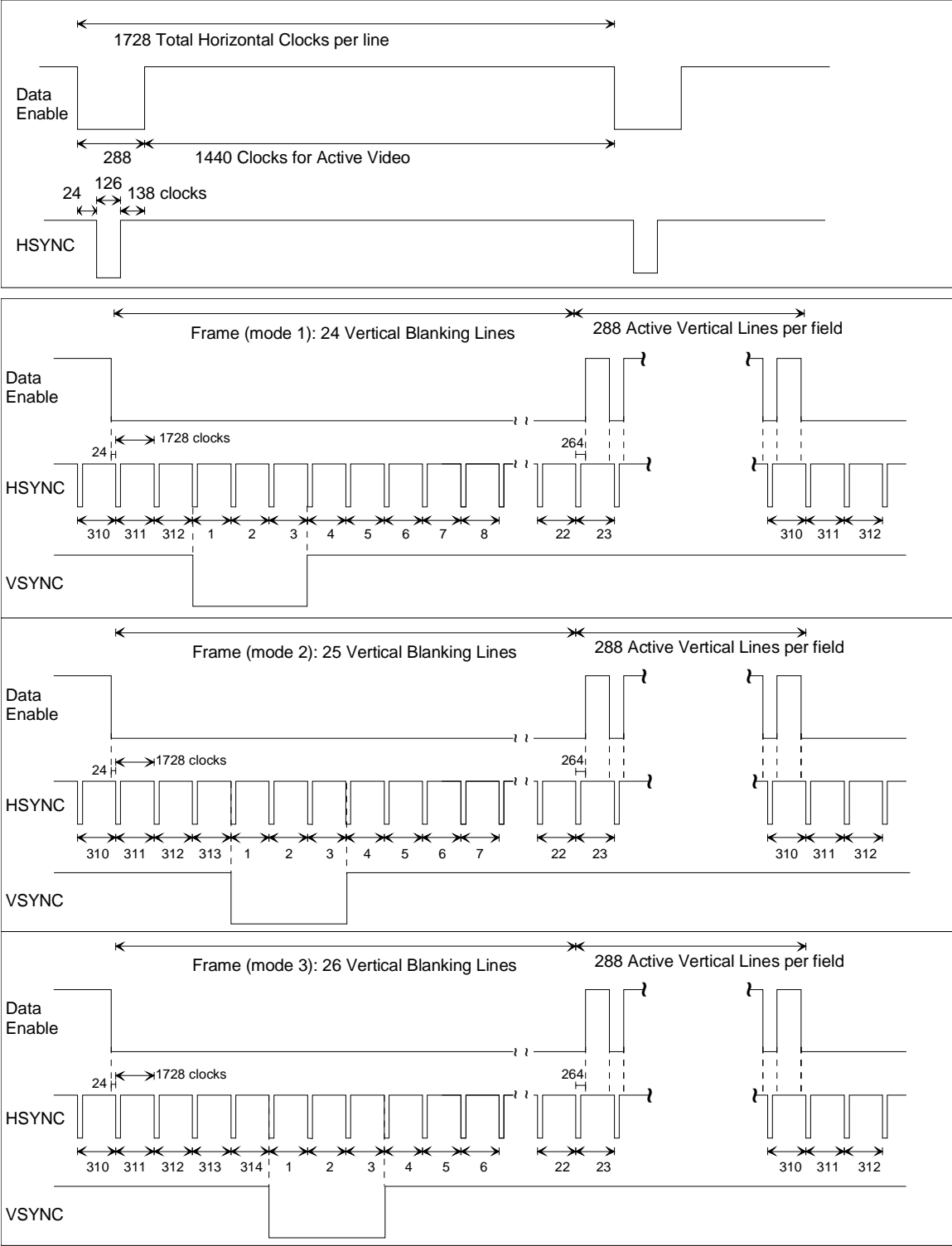

Figure 16. Timing Parameters for 720(1440)X288p @ 50 Hz.

4.17 (2880)X576i @ 50Hz (Formats 25 & 26)

This format is a superset of a variety of video formats used in various game consoles. This format is unique in that, depending upon the pixel repetition factor specified in the AVI InfoFrame, this format can represent any of the following typical formats:

- $2880/10=288$ pixels/line
- $2880/8=360$ pixels/line
- $2880/7=411$ pixels/line
- $2880/5=576$ pixels/line
- $2880/4=720$ pixels/line

The pixel repetition factor is specified in the AVI. The DTV Monitor indicates it can accept any of the formats implied by this format superset through EDID.

This format will also typically have bars on the left and right sides. These bars will be $160/n$ pixels wide where n is the repetition factor.

This format timing can use either 4:3 or 16:9 aspect ratio. The DTV Monitor tells the source device through the EDID structure, which formats it supports. The source device then formats the picture and scales the horizontal resolution for the proper display.

Designers should be aware that this format was not defined at the time when EIA/CEA-861 was published. Because of the repetition factor, this format cannot be used in legacy 861 implementations.

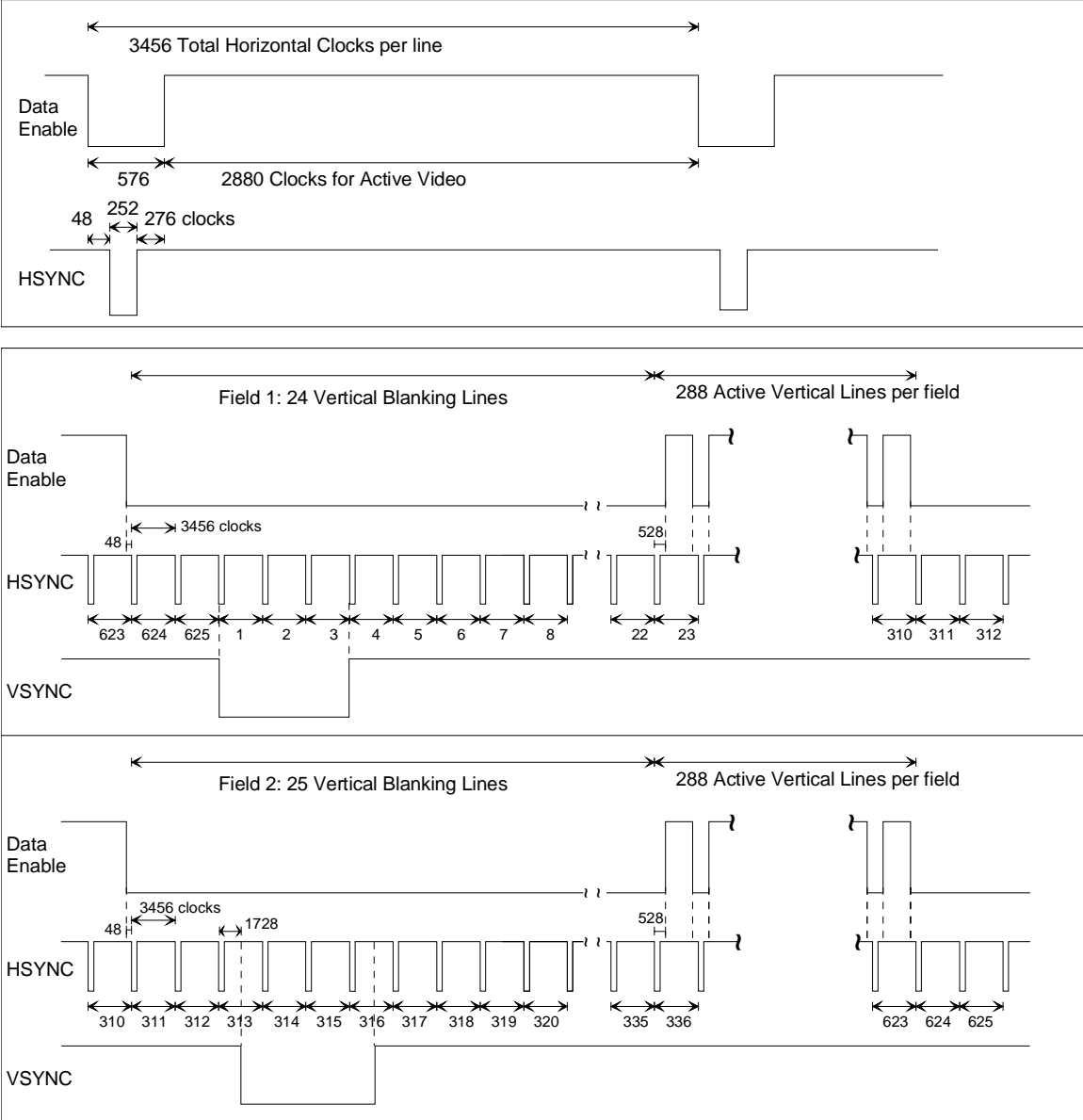

Figure 17. Timing Parameters for (2880)X576i @ 50 Hz

4.18 (2880)X288p @ 50 Hz (Formats 27 & 28)

This format is a superset of a variety of video formats used in various game consoles. This format is unique in that, depending upon the pixel repetition factor specified in the AVI InfoFrame, this format can represent any of the following typical formats:

- $2880/10=288$ pixels/line
- $2880/8=360$ pixels/line
- $2880/7=411$ pixels/line
- $2880/5=576$ pixels/line
- $2880/4=720$ pixels/line

The pixel repetition factor is specified in the AVI. The DTV Monitor indicates it can accept any of the formats implied by this format superset through EDID.

This format will also typically have bars on the left and right sides. These bars will be $160/n$ pixels wide where n is the repetition factor.

There are three possible frame formats that differ only in the number of lines in the vertical blanking interval of the frame. All three are considered variations of the same format.

This format timing can use either 4:3 or 16:9 aspect ratio. The DTV Monitor tells the source device through the EDID structure, which formats it supports. The source device then formats the picture and scales the horizontal resolution for the proper display.

Designers should be aware that this format was not defined at the time when EIA/CEA-861 was published. Because of the repetition factor, this format cannot be used in legacy 861 implementations.

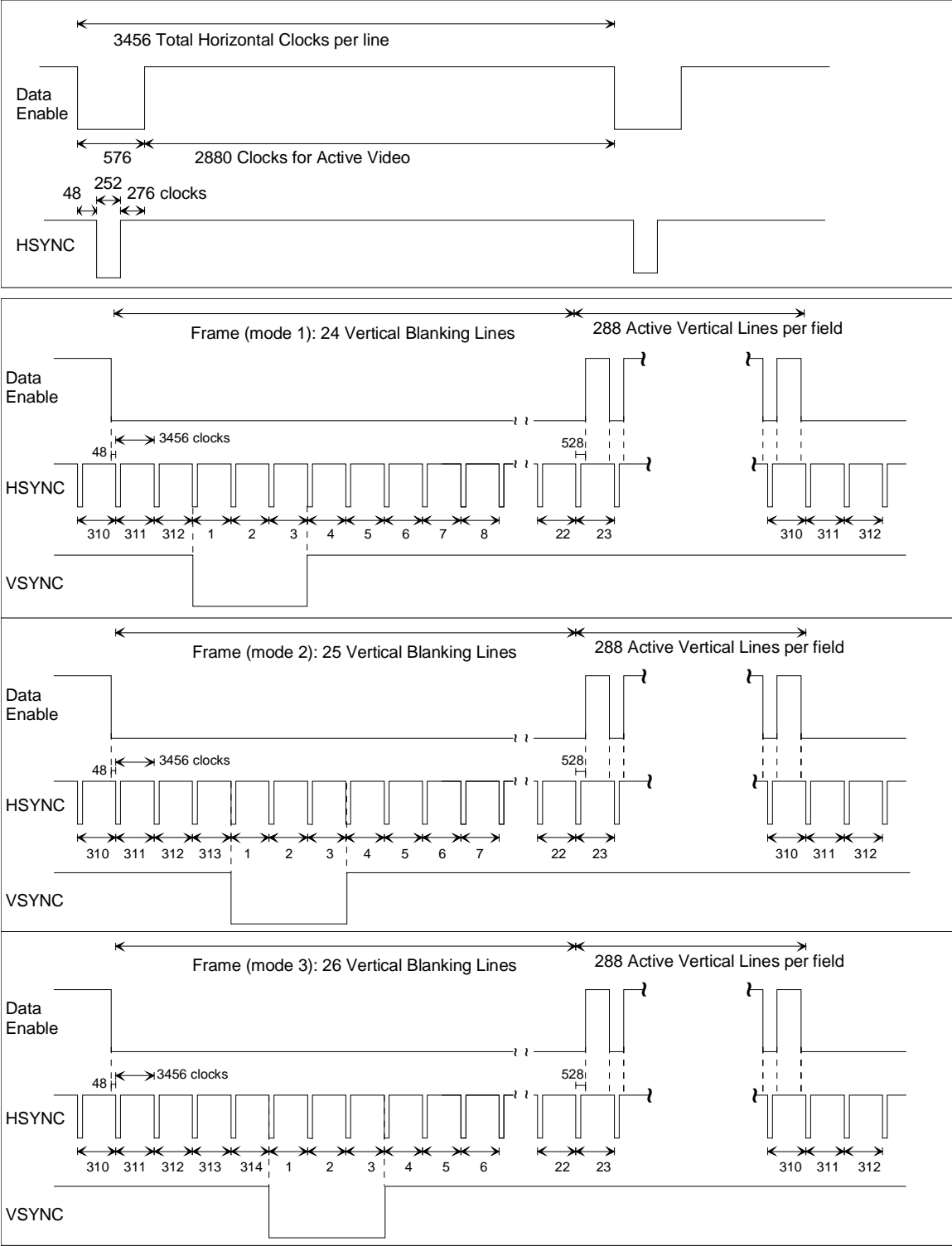

Figure 18. Timing Parameters for (2880)X288p @ 50 Hz.

4.19 1440X576p @ 50Hz (Formats 29 & 30)

This format is for high-end DVD Players. It can use either 4:3 or 16:9 aspect ratio. The DTV Monitor tells the source device through the EDID structure, which formats it supports. The source device then formats the picture and scales the horizontal resolution for the proper display. Designers should be aware that this format was not defined at the time when EIA/CEA-861 was published. Therefore, an 861 type source box will probably not recognize this format in an 18-byte detailed timing descriptor.

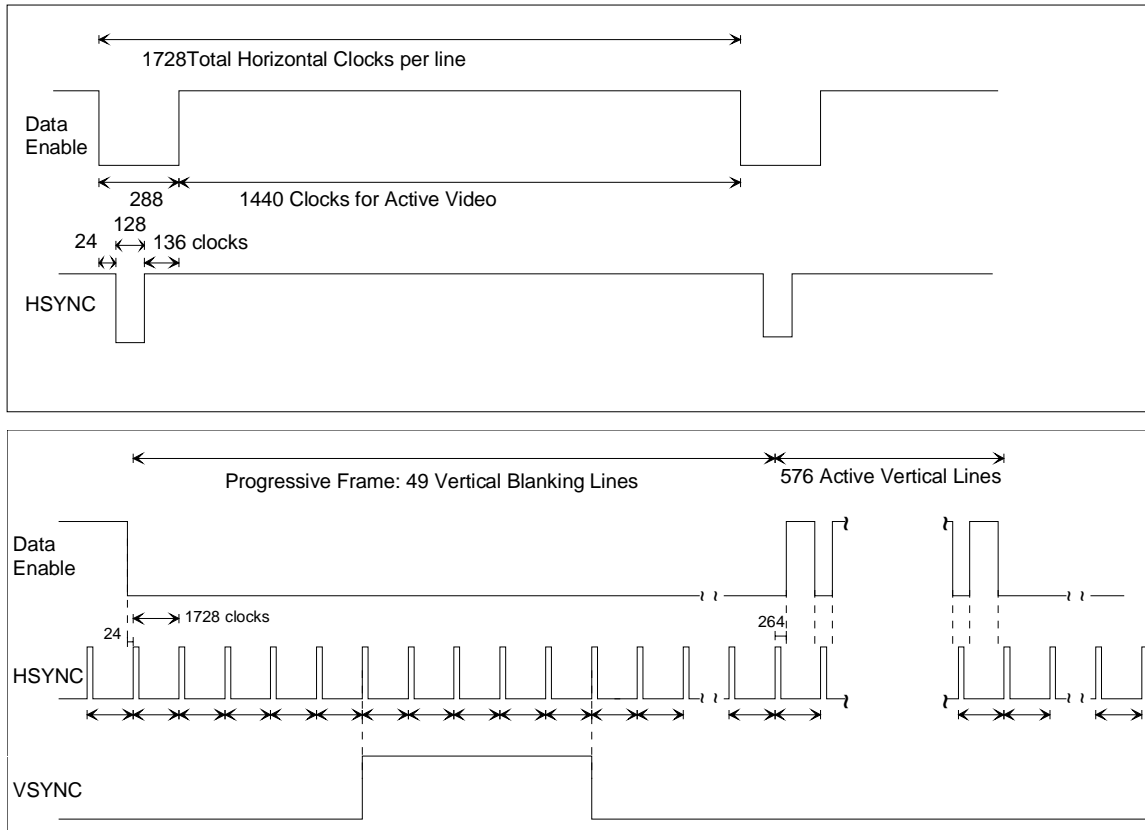

Figure 19. Timing Parameters for 1440X576p @ 50 Hz.

4.20 1920X1080p @ 50 Hz (Format 31)

This format is available only in a 16:9 aspect ratio. Designers should be aware that this format was not defined at the time when EIA/CEA-861 was published. Therefore, an 861 type source box will probably not recognize this format in an 18-byte detailed timing descriptor.

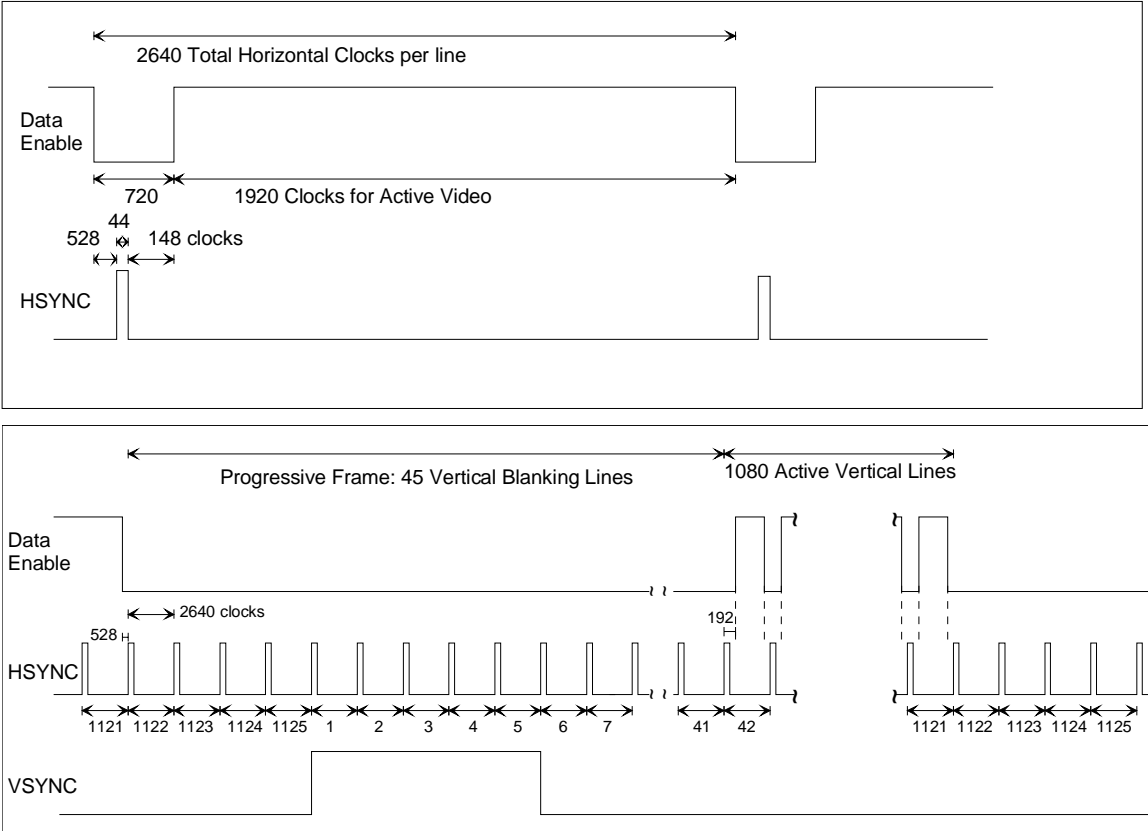

Figure 20. Timing Parameters for 1920X1080p @ 50 Hz.

4.21 1920X1080p @ 23.97/24 Hz (Format 32)

This format is available only in a 16:9 aspect ratio. Designers should be aware that this format was not defined at the time when EIA/CEA-861 was published. Therefore, an 861 type source box will probably not recognize this format in an 18-byte detailed timing descriptor.

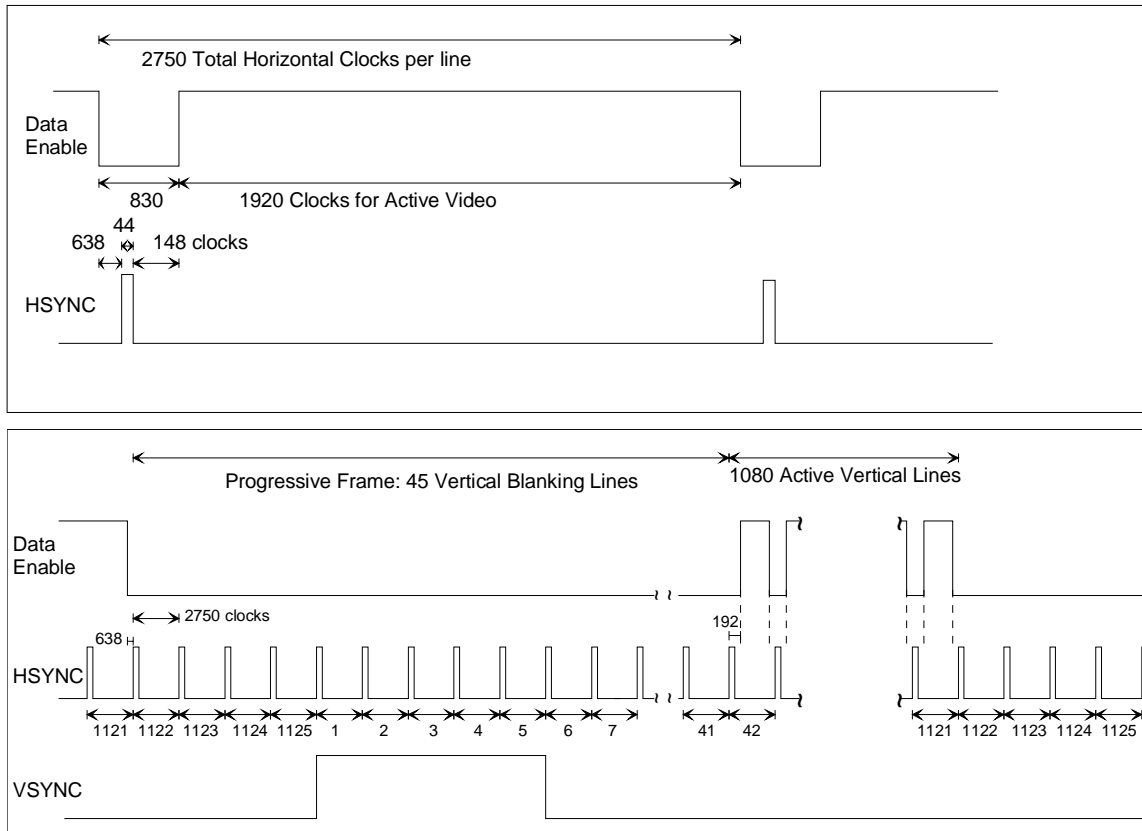

Figure 21. Timing Parameters for 1920X1080p @ 23.97/24 Hz.

4.22 1920X1080p @ 25 Hz (Format 33)

This format is available only in a 16:9 aspect ratio. Designers should be aware that this format was not defined at the time when EIA/CEA-861 was published. Therefore, an 861 type source box will probably not recognize this format in an 18-byte detailed timing descriptor.

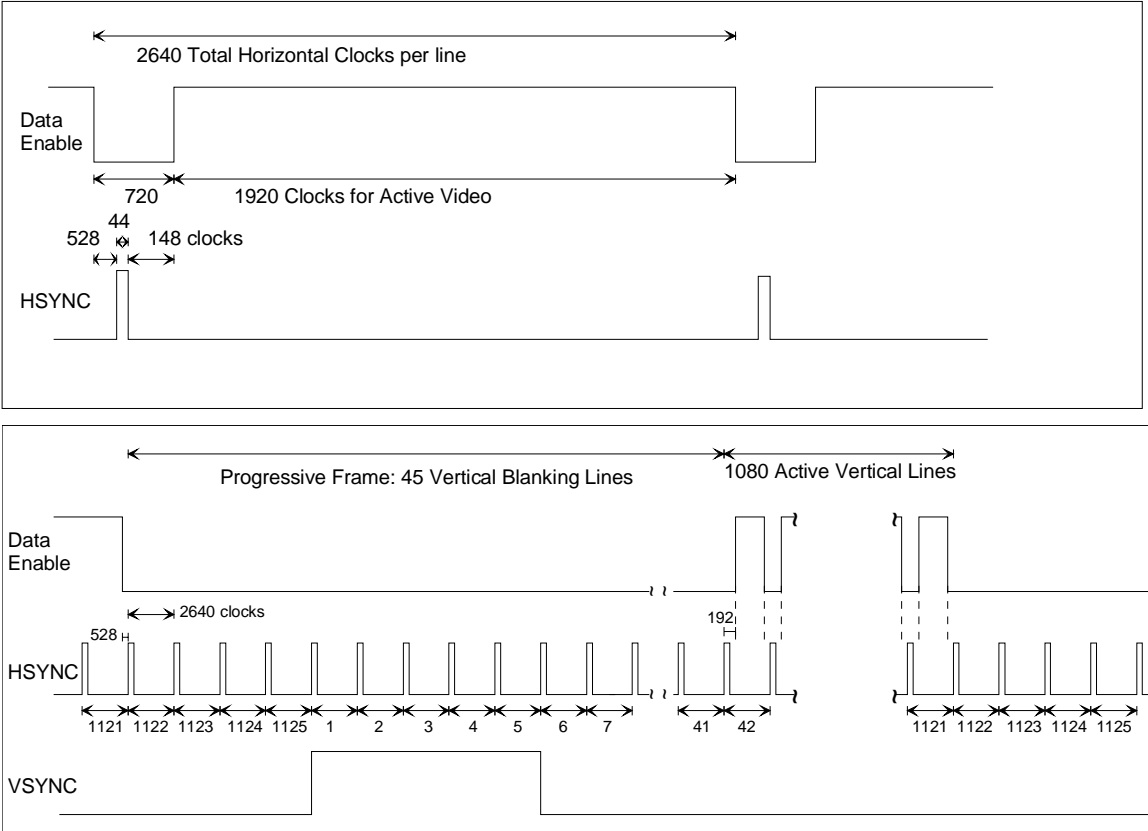

Figure 22. Timing Parameters for 1920X1080p @ 25 Hz.

4.23 1920X1080p @ 29.97/30 Hz (Format 34)

This format is available only in a 16:9 aspect ratio. Designers should be aware that this format was not defined at the time when EIA/CEA-861 was published. Therefore, an 861 type source box will probably not recognize this format in an 18-byte detailed timing descriptor.

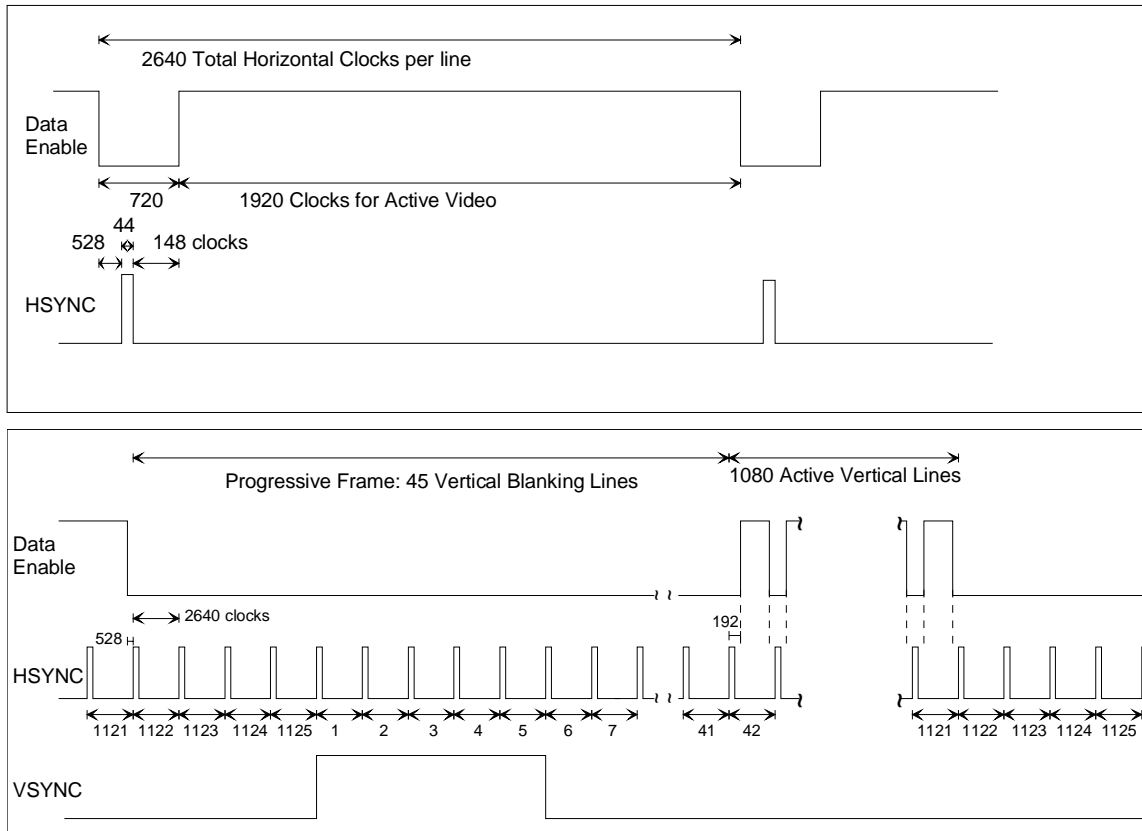

Figure 23. Timing Parameters for 1920X1080p @ 29.97/30 Hz.

4.24 Format Requirements Summary

The required support for the formats defined in this standard is summarized in Table 5.

Table 5. Summary of Video Format Requirements

60 Hz Systems

Format num.	Format	Field Rate	Picture Aspect Ratio (H:V)	Pixel ⁵ Aspect Ratio (H:V)	Requirement on Display
1	640X480p	59.94 Hz, 60 Hz	4:3	1:1	Required (VGA)
2	720X480p	59.94 Hz, 60 Hz	4:3	8:9	At least one of these two is required
3	720X480p	59.94 Hz, 60 Hz	16:9	32:27	
4	1280X720p	59.94 Hz, 60 Hz	16:9	1:1	Optional, but at least one format must be supported for an HDTV Monitor.
5	1920X1080i	59.94 Hz, 60 Hz	16:9	1:1	
6	720(1440)X480i	59.94 Hz, 60 Hz	4:3	8:9	Optional 861A Format
7	720(1440)X480i	59.94 Hz, 60 Hz	16:9	32:27	Optional 861A Format

50 Hz Systems

Format num.	Format	Field Rate	Picture Aspect Ratio (H:V)	Pixel Aspect Ratio (H:V)	Requirement on Display
1	640x480p	59.94 Hz, 60 Hz	4:3	1:1	Required (VGA)
17	720x576p	50 Hz	4:3	16:15	At least one of these two is required
18	720x576p	50 Hz	16:9	64:45	
19	1280x720p	50 Hz	16:9	1:1	Optional, but at least one format must be supported by an HDTV Monitor.
20	1920x1080i	50 Hz	16:9	1:1	
21	720(1440)x576i	50 Hz	4:3	16:15	Optional 861A Format
22	720(1440)x576i	50 Hz	16:9	64:45	Optional 861A Format

⁵ Pixel Aspect Ratio may vary slightly depending on display technology.

The following formats are new to this version of 861 (i.e., 861B) and are optional for both the DTV Monitor and source box.

Table 6. Formats new to this Standard (861B)

Format num.	Formats	Field Rate	Picture Aspect Ratio (H:V)	Pixel Aspect Ratio (H:V)	Requirement on Display
8	720(1440)X240p	59.94Hz/60Hz	4:3	4:9	Optional
9	720(1440)X240p	59.94Hz/60Hz	16:9	16:27	Optional
10	2880X480i	59.94Hz/60Hz	4:3	2:9 - 20:9 ⁶	Optional
11	2880X480i	59.94Hz/60Hz	16:9	8:27 - 80:27	Optional
12	2880X240p	59.94Hz/60Hz	4:3	1:9 - 10:9	Optional
13	2880X240p	59.94Hz/60Hz	16:9	4:27 - 40:27	Optional
14	1440X480p	59.94Hz/60Hz	4:3	4:9	Optional
15	1440X480p	59.94Hz/60Hz	16:9	16:27	Optional
16	1920X1080p	59.94Hz/60Hz	16:9	1:1	Optional
23	720(1440)X288p	50Hz	4:3	8:15	Optional
24	720(1440)X288p	50Hz	16:9	32:45	Optional
25	2880X576i	50Hz	4:3	2:15 - 20:15	Optional
26	2880X576i	50Hz	16:9	16:45-160:45	Optional
27	2880X288p	50Hz	4:3	1:15 - 10:15	Optional
28	2880X288p	50Hz	16:9	8:45 - 80:45	Optional
29	1440X576p	50Hz	4:3	8:15	Optional
30	1440X576p	50Hz	16:9	32:45	Optional
31	1920X1080p	50Hz	16:9	1:1	Optional
32	1920X1080p	23.97Hz/24Hz	16:9	1:1	Optional
33	1920X1080p	25Hz	16:9	1:1	Optional
34	1920X1080p	29.97Hz/30Hz	16:9	1:1	Optional

⁶ Although the pixel repeat field is 4 bits (see Section 6.1.3), the largest value used for typical formats is 10. Therefore, in this standard the pixel repeat value can vary from 1 to 10. This results in a factor of 10 variation in the Pixel Aspect Ratio.

5 COLORIMETRY AND QUANTIZATION

This interface shall be capable of supporting RGB (red, green, and blue), with encoding parameters based on the format. The interface may optionally support $Y C_B C_R$.

5.1 480p, 480i, 576p, 576i, 240p, and 288p

The color space used by the 480-line, 576-line, 240-line, and 288-line formats will likely be based on SMPTE 170M [1].⁷

ITU-R BT.601-5 Section 3.5 [5] (or EIA/CEA-770.2-C Section 3.3 [19]) shall be used for any color space conversion needed in the course of processing unless a different colorimetry is specified in the Auxiliary Video Information InfoFrame.

The encoding parameter values shall be as defined in Table 3 of ITU-R BT.601-5 [5] and are summarized below:

The coding shall be 8-bit coding (scale of 0 to 255). R, G, B, and Y signals shall have 220 quantization levels with the black level corresponding to level 16 and the peak white level corresponding to level 235. The signal level may occasionally move beyond level 235. $C_B C_R$ signals shall have 225 quantization levels with a zero level corresponding to digital level 128 and the full range corresponding with 16 to 240. For R, G, B, Y, C_B , C_R signals, 0 and 255 are reserved and should not be considered video.

The VGA format (i.e., 640X480p) should use all 256 quantization levels.

5.2 1080i, 1080p, and 720p

The color space used by the high definition formats will likely be based on ITU-R BT.709-4 [6].⁷

ITU-R BT.709-4 Part 1, Section 4 [6] (or EIA/CEA-770.3-C Sections 5.4-5.7 [20]) shall be used for any color space conversion needed in the course of processing unless a different colorimetry is specified in the AVI.

The digital representation shall be as defined in Part 1, Section 6.10 of ITU-R BT.709-4 and is summarized below:

The coding shall be 8-bit coding (scale of 0 to 255). R, G, B, and Y signals shall have 220 quantization levels with the black level corresponding to level 16 and the peak white level corresponding to level 235. The signal level may occasionally move beyond level 235. $C_B C_R$ signals shall have 225 quantization levels with a zero level corresponding to digital level 128 and full range corresponding with 16 to 240. For R, G, B, Y, C_B , C_R signals, 0 and 255 are reserved and should not be considered video.

⁷ The service provider (e.g., cable, DBS, terrestrial, etc.) is expected to signal to the source device (receiver, video card, etc.) via its digital Transport Stream, which color space is being transmitted and associated with the video content.

5.3 Recommendations on Conversions to/from Analog Signals

If the digital video signal is converted to an analog signal in the DTV Monitor, it is recommended that for RGB or Y, the black level (i.e., sync level and blanking level) should be aligned with the video portion of the signal at digital levels 16 and the white level at digital level 235, such that the full range of the D/A converted signal is the same as the actual video.⁸ This means that zero analog level (0.0 IRE) should be associated with digital level 16, which implies in some cases removal of a "black level setup" in the display DAC. Digital levels 1 - 15 (undershoot region) and level 235 - 254 (overshoot region) are recommended to be passed through the D/A, however, full range of the analog signal should be aligned with 16-235 since it is expected that essential video is in the 16-235 range. For the 640x480 format, there may be video at these levels; it is recommended that the full 0-255 range be displayed for this format.

If the digital video signal is converted to an analog signal, it is recommended that for the $C_B C_R$ portion of the $Y C_B C_R$ digital signal (P_B, P_R for analog signal), the clamping level (sync level and blanking level) should be aligned with digital level 128 and the full range of the analog signal should be aligned with digital level 16 to 240. However, the D/A may pass the full 1-254 range or may pass levels 16-254.

⁸ RGB signals have the same notation in the digital and analog domains. Typically, Y, C_B , C_R notation is used for digital domains; and Y, P_B , P_R is used for analog domains.

6 AUXILIARY INFORMATION CARRIED FROM SOURCE TO DTV MONITOR

Various types of auxiliary data can be carried from the Source to the DTV Monitor using the InfoFrame/InfoPacket Structure defined in Annex G. This section describes the types of InfoFrames that have been defined so far. The Version 1 AVI was specified in EIA/CEA-861A. This standard (EIA/CEA-861B) adds three more InfoFrames (Source Product Description InfoFrame, Audio InfoFrame, and MPEG Source InfoFrame).

The DTV Monitor's ability to receive and decode various InfoFrames is indicated by its inclusion of specific information in EDID (See the following paragraph and Section 7.1). In most cases, the version number of the CEA Timing Extension indicates support of certain InfoFrames. In a few cases, support of a specific format or specific type of audio indicates support. These requirements will be spelled out in the various sections on each infoFrame, but the specific format of EDID will be covered in Section 7.

Inclusion of the Version 3 (or higher) CEA EDID Timing Extension in the DTV Monitor's EDID data structure indicates to the source device that the DTV monitor is capable of receiving the three newly defined InfoFrames (Source Product Description, Audio, and MPEG Source) and Version 2 AVI InfoFrame in addition to the Version 1 AVI InfoFrame, which appeared in EIA/CEA-861A. The use of the Version 2 CEA Timing Extension in the DTV Monitor's EDID data structure indicates to the source device that the DTV monitor is capable of receiving the Version 1 AVI InfoFrame.

6.1 Auxiliary Video Information (AVI) InfoFrame

The Auxiliary Video Information (AVI) was the main addition from EIA/CEA-861 to EIA/CEA-861A. Its principle use was to indicate to the DTV Monitor the intended picture aspect ratio of a video format timing that is available in more than one picture aspect ratio. The ability to designate in what colorimetry the picture should be displayed and information on the active format were also included. In this standard (861B), pixel repeat information associated with the new 2880 formats has been added. A field that can be used to identify the video format has also been added (i.e., Video Identification Code).

The AVI is carried in the AV-stream from the source device to the DTV Monitor as an InfoFrame within an InfoPacket (see Annex G). Note that the actual mechanism for carrying this information is different depending on the actual digital interface being used⁹.

If the source device supports the transmission of the Auxiliary Video Information (AVI) and if it determines that the DTV Monitor is capable of receiving that information, it shall

⁹ Neither DVI 1.0 [2] nor OpenLDI 0.95 [7] (both of which were suitable for EIA/CEA-861) contain a mechanism for transporting this data. These physical interfaces can be used to implement this standard with reduced functionality (i.e., 861). New physical interfaces that are backward compatible with DVI 1.0 and contain mechanisms for transferring InfoPackets, digital audio, and $YC_B C_R$ pixel data are expected to become available soon. These physical interfaces can be used to implement the full capabilities of this standard.

send the AVI to the DTV Monitor once per frame. The data applies to the next full frame of video data.

In order to convey the information across the interface, a packet structure is used. The general packet structure which consists of “InfoFrames” contained within an “InfoPacket” is defined in Section G.1. The AVI is carried as an InfoFrame within the InfoPacket. An InfoPacket can carry more than one InfoFrame. One InfoPacket can be sent every video frame, and must be sent once every video frame if the source device supports AVI and determines that the DTV Monitor does, too.

Source boxes should be aware that if the DTV Monitor does not use version 2 (or higher) of the CEA EDID Timing Extension and is not a dual aspect ratio DTV monitor¹⁰, then the uncompressed digital video receiver in the DTV monitor may not work properly if AVI information is sent. If the DTV does not use version 2 (or higher) of the CEA EDID Timing Extension with the basic audio bit and one of the YC_BC_R bits set, then the DTV monitor may not work properly if digital audio or YC_BC_R pixel data is sent.

For DTV Monitors that simultaneously support formats available in different aspect ratios (e.g., 720X480p), the DTV Monitor shall be able to receive and decode the Version 1 Auxiliary Video Information (AVI) described in this Section. Simultaneous support of formats available in two different aspect ratios shall be indicated by listing both formats in the EDID data structure at the same time. The DTV shall indicate its support of the Version 1 AVI InfoFrame by using Version 2 (or higher) CEA EDID Timing Extension in the EDID data structure.

If a Dual Aspect Ratio DTV Monitor is receiving a video format timing for which it has declared support for both picture aspect ratios in EDID and the source device has indicated the picture aspect ratio by including the AVI in the video stream, then the DTV Monitor shall display the picture in the aspect ratio that has been indicated by the source device in the AVI. If the source device does not support transmission of the AVI (perhaps it is only EIA/CEA-861 compliant), then the source device shall provide the video to the DTV monitor in the preferred aspect ratio as explained in Section 7.

If, for some reason, an indication is received that conflicts with the video format being received (e.g., the source device indicates 4:3 but sends the 1920X1080i format), then the DTV Monitor shall use the picture aspect ratio that is associated with the format being sent.

¹⁰ In the previous version of this standard (i.e., 861A), it was possible for a DTV Monitor to support the use of the AVI InfoFrame without using the Version 2 CEA Timing Extension as an indication. In that case, the indication was provided through being a Dual Aspect Ratio DTV. It is now required that a Dual Aspect Ratio DTV use either Version 2 or Version 3 of the CEA EDID Timing Extension. However, source boxes should be aware that some older DTV implementations may have been created that only indicate support of the AVI InfoFrame in this manner.

If a DTV Monitor supports the basic audio (see Section 7.4) available on the digital interface being used, then it shall include the version 2 (or higher) CEA Timing Extension with the basic audio bit set, and shall be capable of receiving the AVI.

If a DTV Monitor supports $YCbCr$ (in addition to RGB), then it shall include the version 2 (or higher) CEA Timing Extension with at least one of the $YCbCr$ bits set and shall be capable of receiving the AVI. If no AVI is being sent from the source device, then the DTV Monitor shall assume the video data is RGB.

The information on “Active Format Aspect Ratio,” bar widths, overscan/underscan, non-uniform picture scaling, and colorimetry is information that can be used by the DTV Monitor to improve the picture. Use of this information by the DTV Monitor is optional. If this information is present at the source device and valid,¹¹ and if the DTV Monitor is capable of receiving the AVI, it is required that this information be sent.

For DTV Monitors that would like to receive AVI even though they may not support different aspect ratios, the DTV Monitor shall include version 2 (or higher) of the CEA Timing Extension in the EDID data structure and shall be capable of receiving the AVI.

For DTV Monitors not capable of receiving AVI, the DTV Monitor shall not declare in its EDID data structure more than one format that is the same except for picture aspect ratio at the same time. It shall use version 1 of the CEA Timing Extension if needed to declare additional formats.

6.1.1 Additional Requirements related to Version 2 AVI InfoFrame

Version 2 of the AVI InfoFrame contains additional information such as a Video Identification Code and a Pixel Repeat field (see Section 6.1.3). There are some additional requirements related to this new information. Note that the Version 2 AVI InfoFrame is backward compatible with the Version 1 AVI InfoFrame. Therefore, any DTV Monitor that supports reception of the Version 2 AVI InfoFrame shall also support reception of the Version 1 AVI InfoFrame.

If the DTV Monitor supports any of the new 861B video formats, then it shall be able to receive and interpret Version 2 of the AVI InfoFrame. Support of AVI InfoFrame Version 2 is indicated by the inclusion of the CEA EDID Timing Extension Version 3 in EDID (see Section 7).

If AVI InfoFrame Version 2 is sent from a source box to a DTV Monitor and if one of the video formats defined in this document is being sent, then the Video Identification Code shall be set correctly. If a video format other than one of the formats defined in this document is sent, then the Video Identification Code shall be set to 0. In many cases, the DTV Monitor will be able to determine the video format from the video itself. If the

¹¹ The data may not be valid if, for example, the source box has already post-processed the signal.

Video Identification Code being received in the AVI does not match the video being received, then the DTV Monitor shall ignore the Video Identification Code.

6.1.2 Format of Version 1 AVI InfoFrame

The AVI InfoFrame is constructed with a 2-byte header (Type Code and Version Number) followed by a 1-byte length field followed by 13 bytes of data. The general format of the Version 1 AVI InfoFrame is shown below:

Table 7. Auxiliary Video Information InfoFrame format (Version 1)

InfoFrame Type Code	InfoFrame Type = 02_{16}							
InfoFrame Version Number	Version = 01_{16}							
Length of AVI InfoFrame	Length of AVI InfoFrame (13)							
Data Byte 1	Rsvd=0	Y1	Y0	A0	B1	B0	S1	S0
Data Byte 2	C1	C0	M1	M0	R3	R2	R1	R0
Data Byte 3	Reserved for Future (shall be 0)						SC1	SC0
Data Byte 4	Reserved for Future (shall be 0)							
Data Byte 5	Reserved for Future (shall be 0)							
Data Byte 6	Line Number of End of Top Bar (lower 8 bits)							
Data Byte 7	Line Number of End of Top Bar (upper 8 bits)							
Data Byte 8	Line Number of Start of Bottom Bar (lower 8 bits)							
Data Byte 9	Line Number of Start of Bottom Bar (upper 8 bits)							
Data Byte 10	Pixel Number of End of Left Bar (lower 8 bits)							
Data Byte 11	Pixel Number of End of Left Bar (upper 8 bits)							
Data Byte 12	Pixel Number of Start of Right Bar (lower 8 bits)							
Data Byte 13	Pixel Number of Start of Right Bar (upper 8 bits)							

Data Byte 1 (Table 8) contains bits that describe overscan/underscan (e.g., computer graphics or video), two bits to indicate whether optional $YCbCr$ is being used, and bits that indicate the presence of valid active format and/or bar information. If the bar information and the active format information do not agree, then the bar information shall take precedence.

Table 8. AVI InfoFrame Data Byte 1

F7	Future Use, all Zeros	Y1	Y0	RGB or YCbCr	A0	Active Format Information Present	B1	B0	Bar Info	S1	S0	Scan Information
0		0	0	RGB (default)	0	No Data	0	0	Bar Data not valid	0	0	No Data
		0	1	YCbCr 4:2:2	1	Active Format Information valid	0	1	Vert. Bar Info valid	0	1	Overscanned (television)
		1	0	YCbCr 4:4:4			1	0	Horiz. Bar Info Valid	1	0	Underscanned (Computer)
		1	1	Future			1	1	Vert. and Horiz. Bar Info valid	1	1	Future

Data Byte 2 (Table 9) contains bits that describe colorimetry, picture aspect ratio, and the active format information.

Table 9. AVI InfoFrame Data Byte 2

C1	C0	Colorimetry	M1	M0	Picture Aspect Ratio	R3	R2	R1	R0	Active Format Aspect Ratio
0	0	No Data	0	0	No Data	1	0	0	0	Same as picture aspect ratio
0	1	SMPTE 170M [1] ITU601 [5]	0	1	4:3	1	0	0	1	4:3 (Center)
1	0	ITU709 [6]	1	0	16:9	1	0	1	0	16:9 (Center)
1	1	Future	1	1	Future	1	0	1	1	14:9 (Center)
other values										Per DVB AFD active_format field in [3].

Table 10 illustrates the terminology and examples of common aspect ratio information that can be communicated from a source device to a display device using this standard. It illustrates some of the possibilities for the two standard picture aspect ratios (4:3 and 16:9) with the active format over the picture. The “active format” codes shall be coded in accordance with the Active Format Description¹² (AFD) in the DVB specification[3].¹³

¹² Note that the use of the term “active” in the “Active Format Description” differs from how it is used in other places of this standard and documents referenced by this standard. Active usually refers to any and all addressable pixels. In this case, Active Format refers to the useful information within this active area.

¹³ DVB [3] supports 10 active formats. Other active formats can be supported by the bar information contained in bytes 6-13 of the AVI InfoFrame.

All of the active format codes defined in [3] are reproduced in informative Annex H of this standard.

Table 10. Common Active Formats

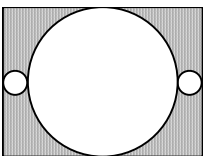
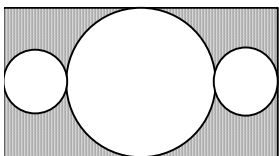
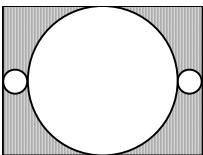
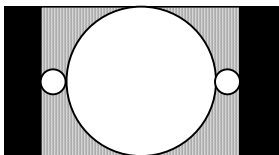
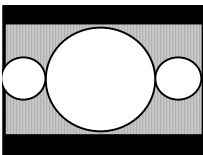
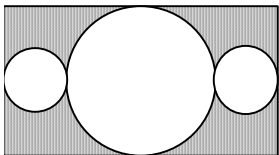
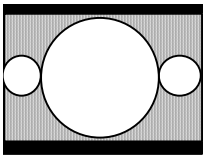
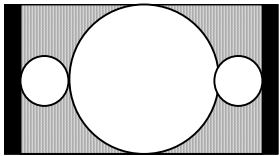
active format		illustration of described format	
Value	Description	4:3 Picture AR	16:9 Picture AR
1000	Same as Picture		
1001	4:3 (center)		
1010	16:9 (center)		
1011	14:9 (center)		

Data Byte 3 (Table 11) contains information on whether the picture has been scaled in a non-uniform way (i.e., unequal along horizontal and vertical dimensions) prior to transmission to the DTV Monitor. The Non-uniform Picture Scaling bits shall be set if the source device scales the picture or has determined that scaling has been performed in a specific direction. If the picture has been stretched or shrunk in a uniform way (i.e., equally along both dimensions), then the bits should not be set. These bits are present to help avoid situations such as the one illustrated in Annex I. All bits labeled as F# are reserved for the future and shall be set to 0.

Table 11. AVI InfoFrame Data Byte 3

F7	F6	F5	F4	F3	F2	Future Use, All zeros	SC1	SC0	Non-uniform Picture Scaling
0	0	0	0	0	0		0	0	No Known non-uniform Scaling
							0	1	Picture has been scaled horizontally
							1	0	Picture has been scaled vertically
							1	1	Picture has been scaled horizontally and vertically

Data Bytes 4 and 5 are reserved for the future and shall be set to 0.

Data Bytes 6 through 13 contain the size of bars as shown in Table 7. The 8 bytes of bar data are present in the AVI whether their information is valid or not. The packets and bits are defined below.

For the purposes of the Line Number and the Pixel Number, the pixel in the upper left hand corner is considered to be in row 1, column 1. Lines and pixels are numbered consecutively as they would appear on a display.¹⁴ All of the values are unsigned integers.

Line Number of End of Top Bar - An unsigned integer value representing the last line of a horizontal letterbox bar area at the top of the picture. Zero means no horizontal bar is present at the top of the picture.

Line Number of Start of Bottom Bar - An unsigned integer value representing the first line of a horizontal letterbox bar area at the bottom of the picture. If greater than the Maximum Vertical Active Lines of the known format, no horizontal bar is present at the bottom of the picture.

Pixel Number of End of Left Bar - An unsigned integer value representing the last horizontal pixel of a vertical pillar-bar area at the left side of the picture. Zero means no vertical bar is present on the left of the picture.

Pixel Number of Start of Right Bar - An unsigned integer value representing the first horizontal pixel of a vertical pillar-bar area at the right side of the picture. If greater than the Maximum Horizontal Pixels of the known format, no vertical bar is present on the right side of the picture.

¹⁴ In this context, line numbers are not the same as the line numbers used in timing diagrams.

6.1.3 Format of Version 2 AVI InfoFrame

The format of the Version 2 AVI InfoFrame is backward compatible with Version 1. Because of this, all of the fields that were contained in the Version 1 AVI InfoFrame are also contained in the Version 2 AVI InfoFrame. Their purpose and use remain unchanged. The Data Bytes that appear in the Version 1 AVI InfoFrame were described in Section 6.1.2 and will not be described here. Only the new fields will be described. The Version 2 AVI InfoFrame is shown below in Table 12:

Table 12. Auxiliary Video Information (AVI) InfoFrame format (Version 2)

InfoFrame Type Code	InfoFrame Type = 02 ₁₆							
InfoFrame Version Number	Version = 02 ₁₆							
Length of AVI InfoFrame	Length of AVI InfoFrame (13)							
Data Byte 1	Rsvd= 0	Y1	Y0	A0	B1	B0	S1	S0
Data Byte 2	C1	C0	M1	M0	R3	R2	R1	R0
Data Byte 3	Reserved (shall be 0)						SC1	SC0
Data Byte 4	Rsvd= 0	VIC6	VIC5	VIC4	VIC3	VIC2	VIC1	VIC0
Data Byte 5	Reserved (shall be 0)				PR3	PR2	PR1	PR0
Data Byte 6	Line Number of End of Top Bar (lower 8 bits)							
Data Byte 7	Line Number of End of Top Bar (upper 8 bits)							
Data Byte 8	Line Number of Start of Bottom Bar (lower 8 bits)							
Data Byte 9	Line Number of Start of Bottom Bar (upper 8 bits)							
Data Byte 10	Pixel Number of End of Left Bar (lower 8 bits)							
Data Byte 11	Pixel Number of End of Left Bar (upper 8 bits)							
Data Byte 12	Pixel Number of Start of Right Bar (lower 8 bits)							
Data Byte 13	Pixel Number of Start of Right Bar (upper 8 bits)							

Data Bytes 4 and 5 were previously reserved. They now have a purpose as described below.

Data Byte 4 contains a Video Identification Code. In most cases, the video format can be uniquely determined from the video format timing itself. However, if the source box is sending one of the video formats defined in this document, then it shall set this field to the proper code. If this field is used and if it is inconsistent with the video format being received, then it shall be ignored by the DTV Monitor. If the picture aspect ratio implied by this field does not agree with the picture aspect ratio communicated in Data Byte 2, then Data Byte 2 shall take precedence. The codes associated with each video format are shown in Table 13. Note that these same codes are used in the Short Video Descriptors used in the Version 3 CEA EDID Timing Extension, which is described in Section 7.5. If the source device needs to convey “no information” regarding the video

format (perhaps it is sending a proprietary format that was defined using the EDID 18-Byte Detailed Timing Descriptor in the DTV Monitor), then this field shall be set to 0.

Table 13. Video Identification Codes for AVI InfoFrame Data Byte 4 and CEA Short Descriptors

Video Codes	Horizontal (pixels)	Vertical (pixels)	i/p	Vertical Frequency	Aspect Ratio	Where Defined	Remark
1	640	480	p	59.94/60Hz	4:3	861	Default format
2	720	480	p	59.94/60Hz	4:3	861	EDTV
3	720	480	p	59.94/60Hz	16:9	861	EDTV
4	1280	720	p	59.94/60Hz	16:9	861	HDTV
5	1920	1080	i	59.94/60Hz	16:9	861	HDTV
6	720(1440)	480	i	59.94/60Hz	4:3	861 Optional	Double clock for 720x480i
7	720(1440)	480	i	59.94/60Hz	16:9	861 Optional	Double clock for 720x480i
8	720(1440)	240	p	59.94/60Hz	4:3	New	Double clock for 720x240p
9	720(1440)	240	p	59.94/60Hz	16:9	New	Double clock for 720x240p
10	(2880)	480	i	59.94/60Hz	4:3	New	Game Console
11	(2880)	480	i	59.94/60Hz	16:9	New	Game Console
12	(2880)	240	p	59.94/60Hz	4:3	New	Game Console
13	(2880)	240	p	59.94/60Hz	16:9	New	Game Console
14	1440	480	p	59.94/60Hz	4:3	New	high-end DVD
15	1440	480	p	59.94/60Hz	16:9	New	high-end DVD
16	1920	1080	p	59.94/60Hz	16:9	New	Optional HDTV
17	720	576	p	50 Hz	4:3	861A	EDTV
18	720	576	p	50 Hz	16:9	861A	EDTV
19	1280	720	p	50 Hz	16:9	861A	HDTV
20	1920	1080	i	50 Hz	16:9	861A	HDTV
21	720(1440)	576	i	50 Hz	4:3	861A Optional	Double clock for 720x576i
22	720(1440)	576	i	50 Hz	16:9	861A Optional	Double clock for 720x576i
23	720(1440)	288	p	50 Hz	4:3	New	Double clock for 720x288p
24	720(1440)	288	p	50 Hz	16:9	New	Double clock for 720x288p
25	(2880)	576	i	50 Hz	4:3	New	Game Console
26	(2880)	576	i	50 Hz	16:9	New	Game Console
27	(2880)	288	p	50 Hz	4:3	New	Game Console
28	(2880)	288	p	50 Hz	16:9	New	Game Console
29	1440	576	p	50 Hz	4:3	New	high-end DVD
30	1440	576	p	50 Hz	16:9	New	high-end DVD
31	1920	1080	p	50 Hz	16:9	New	Optional HDTV
32	1920	1080	p	23.97/24Hz	16:9	New	Optional HDTV
33	1920	1080	p	25 Hz	16:9	New	Optional HDTV
34	1920	1080	p	29.97/30Hz	16:9	New	Optional HDTV
35-127	Reserved for the Future						
0	No Video Code Available (Used with AVI InfoFrame only)						

Data Byte 5 indicates to the DTV Monitor how many repetitions of each unique pixel are transmitted for the optional (2880)X480i/240p or (2880)X576/288p formats. These are the only formats that allow for a range of values. In those cases, the AVI shall be sent to the DTV Monitor with this field set correctly and the DTV Monitor shall properly

interpret it. As with all video formats, the source box shall read the EDID to determine if the specific (2880) format is supported before it sends it.

If the Version 2 AVI InfoFrame is sent, then the Pixel Repeat field shall be set correctly no matter what video format is being transmitted. In non-repeated formats, this value is 0. For pixel-repeated formats, this value indicates the number of pixels that shall be decimated by the receiver or repeated depending on the signal process. In all cases, the first transmitted pixel data of a line of video is unique. Subsequent pixels will be repetition(s) of the previous pixel if pixel repetition is used. The values for Pixel Repeat are shown in Table 14.

Table 14. AVI InfoFrame Data Byte 5

PR3	PR2	PR1	PR0	Pixel Repetition for Optional (2880)
0	0	0	0	No Repetition (i.e., pixel sent once)
0	0	0	1	pixel sent 2 times (i.e., repeated once)
0	0	1	0	pixel sent 3 times
0	0	1	1	pixel sent 4 times
0	1	0	0	pixel sent 5 times
0	1	0	1	pixel sent 6 times
0	1	1	0	pixel sent 7 times
0	1	1	1	pixel sent 8 times
1	0	0	0	pixel sent 9 times
1	0	0	1	pixel sent 10 times
0Ah-0Fh				Reserved

A list of allowable Pixel Repeat values for each CEA format timing is shown in Table 15. Note that this characteristic is independent of Picture Aspect Ratio.

Table 15. Valid Pixel Repeat Values for each video format timing

Video Codes	Video Description	Valid Pixel Repeat Values
1	640X480p @ 59.94/60Hz	No Repetition
2, 3	720X480p @ 59.94/60Hz	No Repetition
4	1280X720p @ 59.94/60Hz	No Repetition
5	1920X1080i @ 59.94/60Hz	No Repetition
6, 7	720(1440)X480i @ 59.94/60Hz	pixel sent 2 times
8, 9	720(1440)X240p @ 59.94/60Hz	pixel sent 2 times
10, 11	2880X480i @ 59.94/60Hz	pixel sent 1 to 10 times
12, 13	2880X240p @ 59.94/60Hz	pixel sent 1 to 10 times
14, 15	1440X480p @ 59.94/60Hz	No Repetition
16	1920X1080p @ 59.94/60Hz	No Repetition
17, 18	720X576p @ 50Hz	No Repetition
19	1280X720p @ 50Hz	No Repetition
20	1920X1080i @ 50Hz	No Repetition
21, 22	720(1440)X576i @ 50Hz	pixel sent 2 times
23, 24	720(1440)X288p @ 50Hz	pixel sent 2 times
25, 26	2880X576i @ 50Hz	pixel sent 1 to 10 times
27, 28	2880X288p @ 50Hz	pixel sent 1 to 10 times
29, 30	1440X576p @ 50Hz	No Repetition
31	1920X1080p @ 50Hz	No Repetition
32	1920X1080p @ 23.97/24Hz	No Repetition
33	1920X1080p @ 25Hz	No Repetition
34	1920X1080p @ 29.97/30Hz	No Repetition

6.2 Source Product Description (SPD) InfoFrame.

The Source Product Description (SPD) InfoFrame is a new feature of EIA/CEA-861B. It contains information that is useful for communicating the name of the source device. This is useful for setting up source-selection-screens in the DTV Monitor.

Support of the SPD InfoFrame in the DTV Monitor is indicated by including version 3 of the CEA EDID Timing Extension in the DTV Monitor's EDID data structure. The transmission of this infoFrame is optional for the source device. The use of the information by the DTV Monitor is also optional. It shall not be sent more than once per video frame. If used, it is recommended that it be sent once every second.

The format of the Source Product Description InfoFrame is shown below in Table 16. See Annex G for the general format of InfoFrame and InfoPackets.

Table 16. Source Product Description InfoFrame format

InfoFrame Type Code	InfoFrame Type = 03 ₁₆ (new)	
InfoFrame Version Number	Version = 01 ₁₆	
Length of Source Product Description InfoFrame	Length of Source Product Description InfoFrame = 25	
Data Byte 1	0	Vendor Name Character 1 VN1 (7bit ASCII code)
Data Byte 2	0	Vendor Name Character 2 VN2
Data Byte 3	0	Vendor Name Character 3 VN3
Data Byte 4	0	Vendor Name Character 4 VN4
Data Byte 5	0	Vendor Name Character 5 VN5
Data Byte 6	0	Vendor Name Character 6 VN6
Data Byte 7	0	Vendor Name Character 7 VN7
Data Byte 8	0	Vendor Name Character 8 VN8
Data Byte 9	0	Product Description Character 1 PD1 (7-bit ASCII code)
Data Byte 10	0	Product Description Character 2 PD2
Data Byte 11	0	Product Description Character 3 PD3
Data Byte 12	0	Product Description Character 4 PD4
Data Byte 13	0	Product Description Character 5 PD5
Data Byte 14	0	Product Description Character 6 PD6
Data Byte 15	0	Product Description Character 7 PD7
Data Byte 16	0	Product Description Character 8 PD8
Data Byte 17	0	Product Description Character 9 PD9
Data Byte 18	0	Product Description Character 10 PD10
Data Byte 19	0	Product Description Character 11 PD11
Data Byte 20	0	Product Description Character 12 PD12
Data Byte 21	0	Product Description Character 13 PD13
Data Byte 22	0	Product Description Character 14 PD14
Data Byte 23	0	Product Description Character 15 PD15
Data Byte 24	0	Product Description Character 16 PD16
Data Byte 25		Source Device Information (see below)

The Vendor Name consists of eight 7-bit ASCII characters. The name should be left justified (i.e., first character in Data Byte 1) and all unused characters should be Null (i.e., 00₁₆). The Vendor Name is intended to be the name of the company whose name appears on the product. The Product Description (contained in Data Bytes 9-24) consists of sixteen 7-bit ASCII characters. This code is meant to be the model number of the product and may contain a short description also (e.g., RC5240 DVD Plyer). Data Byte 25 consists of a code that classifies the source device. Codes for the most common types of source devices are shown in Table 17.

Table 17. Source Product Description InfoFrame Data Byte 25

Code	Source Device Information
00h	unknown
01h	Digital STB
02h	DVD
03h	D-VHS
04h	HDD Video
05h	DVC
06h	DSC
07h	Video CD
08h	Game
09h	PC general
0Ah	Reserved
...	
FFh -	

6.3 Audio InfoFrame.

The Audio InfoFrame is new to this version of 861 (i.e., EIA/CEA-861B). It contains information that allows for the format of the digital audio streams to be identified more quickly via out-of-band information and for multi-channel LPCM, provides channel allocation information for the sink device's speakers.

If the DTV Monitor supports digital audio other than what is designated to be "Basic Audio" (see Section 7.4 and Section 2.4), it shall be able to receive Version 1 of the Audio InfoFrame and be able to interpret the audio identification information in Data Bytes 1-3. Support for digital audio other than basic audio is indicated in the Version 3 (or higher) CEA EDID Timing Extension (see Section 7.5). The ability to receive the Audio InfoFrame in the DTV Monitor is indicated by including the version 3 (or higher) CEA EDID Timing Extension in the DTV Monitor's EDID data structure.

If the DTV Monitor supports multi-channel LPCM (i.e., more than 2 channels) and has included speaker placement information in EDID (see Section 7.5), it shall be able to interpret the speaker channel assignment information and down-mix information in Data Bytes 4 & 5.

If the source device supports the transmission of the Audio InfoFrame and if it determines that the DTV Monitor is capable of receiving the Audio InfoFrame (i.e., the DTV Monitor has included CEA Timing Extension Version 3 in EDID) and digital audio, then the Audio InfoFrame, with Data Bytes 1 through 3 set correctly, shall be sent once per video frame while digital audio is being sent across the interface. The data applies to the audio associated with the next full frame of video data.

If the source device is sending multi-channel LPCM, then it shall also send valid speaker channel allocation information and down-mix information in Data Bytes 4 & 5 of this InfoFrame.

The format of the Audio InfoFrame is shown in Table 18. See Annex G for the General format of InfoFrame and InfoPackets.

Table 18. Audio InfoFrame format

InfoFrame Type Code	InfoFrame Type = 04 ₁₆ (new)							
InfoFrame Version Number	Version = 01 ₁₆							
Length of Audio InfoFrame	Length of Audio InfoFrame (10)							
Data Byte 1	CT3	CT2	CT1	CT0	Rsvd	CC2	CC1	CC0
Data Byte 2	Reserved (shall be 0)			SF2	SF1	SF0	SS1	SS0
Data Byte 3	Format depends on coding type (i.e., Data Byte 1)							
Data Byte 4	CA7	CA6	CA5	CA4	CA3	CA2	CA1	CA0
Data Byte 5	DM_I NH	LSV3	LSV2	LSV1	LSV0	Reserved (shall be 0)		
Data Byte 6	Reserved (shall be 0)							
Data Byte 7	Reserved (shall be 0)							
Data Byte 8	Reserved (shall be 0)							
Data Byte 9	Reserved (shall be 0)							
Data Byte 10	Reserved (shall be 0)							

6.3.1 Audio Identification Information

The information in Data Bytes 1-3 is useful in identifying the audio more quickly. If the DTV and the source device support more than “basic audio,” as defined by the physical/link specification, then this information shall be sent and shall accurately identify the stream while digital audio is being sent. If the source device only supports basic audio, it is not required to send this information (for backward compatibility with 861A), but it is recommended. In most cases, it is possible to identify the audio by parsing the actual audio stream (e.g., as specified in IEC61937 [25]). In cases where the audio information in the Audio InfoFrame does not agree with the actual audio stream being received, this additional information shall be ignored.

Note that the format of Data Byte 3 depends on the Audio Coding Type which is contained in Data Byte 1 (see Table 19). For the LPCM (i.e., uncompressed) audio, this data byte is not used and shall be considered reserved (i.e., all 0s). For any of the compressed audio formats (i.e., AC-3, MPEG1, MP3, MPEG2 multi-channel, AAC, or DTS), this field multiplied by 8 kHz represents the maximum bit rate of the audio stream. For compressed audio streams, the sample size in Data Byte 2 (see Table 20) is not applicable and shall be set to 00.

Table 19. Audio InfoFrame Data Byte 1

CT3	CT2	CT1	CT0	Auido Coding Type	CC2	CC1	CC0	Audio Channel Count
0	0	0	0	Refer to Stream Header	0	0	0	Refer to Stream Header
0	0	0	1	IEC60958 PCM [26, 27]	0	0	1	2ch
0	0	1	0	AC-3	0	1	0	3ch
0	0	1	1	MPEG1 (Layers 1 & 2)	0	1	1	4ch
0	1	0	0	MP3 (MPEG1 Layer 3)	1	0	0	5ch
0	1	0	1	MPEG2 (multichannel)	1	0	1	6ch
0	1	1	0	AAC	1	1	0	7ch
0	1	1	1	DTS	1	1	1	8ch
1	0	0	0	ATRAC				
09h-0Fh				Reserved				

Table 20. Audio InfoFrame Data Byte 2

SF2	SF1	SF0	Sampling Frequency	SS1	SS0	Sample Size
0	0	0	Refer to Stream Header	0	0	Refer to Stream header
0	0	1	32 kHz	0	1	16 bit
0	1	0	44.1 kHz (CD)	1	0	20 bit
0	1	1	48 kHz	1	1	24 bit
1	0	0	88.2 kHz			
1	0	1	96 kHz			
1	1	0	176.4 kHz			
1	1	1	192 kHz			

6.3.2 Speaker Mapping and Down-mix Information

Data Bytes 4 and 5 apply only to multi-channel LPCM (i.e., more than two channels).

This standard contains the possibility to transmit Multi-Channel Linear Pulse Code Modulation (LPCM) Audio by using up to four IEC60958 compliant transport streams. This is because the Audio InfoFrame and the CEA EDID Timing Extension are capable of supporting up to eight channels of LPCM. However, additional information is required to support carriage of Multi-Chanel LPCM streams. This information is provided by the speaker channel allocation information in Data Byte 4.

Data Byte 4 contains information that describes how various speaker locations are allocated to transmission channels. Data Byte 5 contains information that tells the DTV Monitor how much the source device attenuated the audio during a down-mixing operation. The down-mix inhibit flag (DM_INH) describes whether audio output is permitted to be down-mixed or not. This flag is used in DVD Audio applications.

The labels and placements of speakers used in this standard are defined in Figure 24 and Table 21.

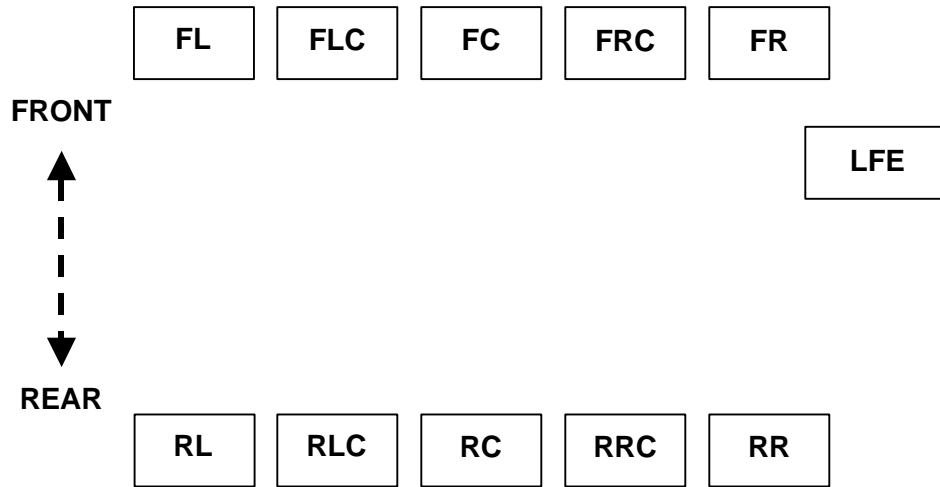

Figure 24 Speaker Placement

Table 21 Speaker Placement

FL	Front Left
FC	Front Center
FR	Front Right
FLC	Front Left Center
FRC	Front Right Center
RL	Rear Left
RC	Rear Center
RR	Rear Right
RLC	Rear Left Center
RRC	Rear Right Center
LFE	Low Frequency Effect

Data Byte 4 contains information that describes how various speaker locations are allocated to transmission channels. The channel allocation is shown in Table 22.

Table 22 Audio InfoFrame Data Byte 4

CA								Channel Number							
7	6	5	4	3	2	1	0	8	7	6	5	4	3	2	1
0	0	0	0	0	0	0	0	-	-	-	-	-	-	FR	FL
0	0	0	0	0	0	0	1	-	-	-	-	-	LFE	FR	FL
0	0	0	0	0	0	1	0	-	-	-	-	FC	-	FR	FL
0	0	0	0	0	0	1	1	-	-	-	-	FC	LFE	FR	FL
0	0	0	0	0	1	0	0	-	-	-	RC	-	-	FR	FL
0	0	0	0	0	1	0	1	-	-	-	RC	-	LFE	FR	FL
0	0	0	0	0	1	1	0	-	-	-	RC	FC	-	FR	FL
0	0	0	0	0	1	1	1	-	-	-	RC	FC	LFE	FR	FL
0	0	0	0	1	0	0	0	-	-	RR	RL	-	-	FR	FL
0	0	0	0	1	0	0	1	-	-	RR	RL	-	LFE	FR	FL
0	0	0	0	1	0	1	0	-	-	RR	RL	FC	-	FR	FL
0	0	0	0	1	0	1	1	-	-	RR	RL	FC	LFE	FR	FL
0	0	0	0	1	1	0	0	-	RC	RR	RL	-	-	FR	FL
0	0	0	0	1	1	0	1	-	RC	RR	RL	-	LFE	FR	FL
0	0	0	0	1	1	1	0	-	RC	RR	RL	FC	-	FR	FL
0	0	0	0	1	1	1	1	-	RC	RR	RL	FC	LFE	FR	FL
0	0	0	1	0	0	0	0	RRC	RLC	RR	RL	-	-	FR	FL
0	0	0	1	0	0	0	1	RRC	RLC	RR	RL	-	LFE	FR	FL
0	0	0	1	0	0	1	0	RRC	RLC	RR	RL	FC	-	FR	FL
0	0	0	1	0	0	1	1	RRC	RLC	RR	RL	FC	LFE	FR	FL
0	0	0	1	0	1	0	0	FRC	FLC	-	-	-	-	FR	FL
0	0	0	1	0	1	0	1	FRC	FLC	-	-	-	LFE	FR	FL
0	0	0	1	0	1	1	0	FRC	FLC	-	-	FC	-	FR	FL
0	0	0	1	0	1	1	1	FRC	FLC	-	-	FC	LFE	FR	FL
0	0	0	1	1	0	0	0	FRC	FLC	-	RC	-	-	FR	FL
0	0	0	1	1	0	0	1	FRC	FLC	-	RC	-	LFE	FR	FL
0	0	0	1	1	0	1	0	FRC	FLC	-	RC	FC	-	FR	FL
0	0	0	1	1	0	1	1	FRC	FLC	-	RC	FC	LFE	FR	FL
0	0	0	1	1	1	0	0	FRC	FLC	RR	RL	-	-	FR	FL
0	0	0	1	1	1	0	1	FRC	FLC	RR	RL	-	LFE	FR	FL
0	0	0	1	1	1	1	0	FRC	FLC	RR	RL	FC	-	FR	FL
0	0	0	1	1	1	1	1	FRC	FLC	RR	RL	FC	LFE	FR	FL
0	0	1	0	0	0	0	0	Reserved							
...															
1	1	1	1	1	1	1	1								

The sink device's speaker allocation is not always the same as that contained within the source audio. In this case, the source device should down mix the audio in order to properly meet the sink device's speaker configuration. In actual implementations, all down-mix coefficients are equally attenuated to prevent calculation overflows. The total sound level becomes lower after down-mixing. For this reason, the Level Shift Value should also be transmitted to the sink device to insure the proper sound level is achieved.

Data Byte 5 contains Level Shift Information and a Down-mix Inhibit Flag.

The values of attenuation associated with the Level Shift Values (LSV0-LSV3) are shown in Table 23.

Table 23 Audio InfoFrame Data Byte 5, Level Shift Value

LSV3	LSV2	LSV1	LSV0	Level Shift Value
0	0	0	0	0dB
0	0	0	1	1dB
0	0	1	0	2dB
0	0	1	1	3dB
0	1	0	0	4dB
0	1	0	1	5dB
0	1	1	0	6dB
0	1	1	1	7dB
1	0	0	0	8dB
1	0	0	1	9dB
1	0	1	0	10dB
1	0	1	1	11dB
1	1	0	0	12dB
1	1	0	1	13dB
1	1	1	0	14dB
1	1	1	1	15dB

The Down-mix Inhibit Flag is shown in Table 24.

Table 24 Audio InfoFrame Data Byte 5, Down-mix Inhibit Flag

DM_INH	Describes whether the down mixed stereo output is permitted or not.
0	Permitted or no information about any assertion of this
1	Prohibited

6.4 MPEG Source (MS) InfoFrame.

The MPEG Source (MS) InfoFrame is new to this version of 861 (i.e., EIA/CEA-861B). It describes aspects of the compressed video stream that were used to produce the uncompressed video. In many cases, the compressed source will be MPEG2, although this InfoFrame can be applied to any similar compressed format. Some DTV Monitors will be able to use this information to improve the displayed picture.

Transmission of this information by the source device is optional. Use of this information by the DTV Monitor is also optional. However, if the DTV Monitor has

included Version 3 (or higher) of the CEA EDID Timing Extension in its EDID data structure, it shall be able to receive Version 1 of this InfoFrame.

If the source device supports the transmission of the MS InfoFrame and if it determines that the DTV Monitor is capable of receiving the MS InfoFrame (i.e., the DTV Monitor has included CEA Timing Extension Version 3 in EDID), then this information should be sent once per video frame when applicable. The data applies to the next full frame of video data.

The format of the MS InfoFrame is shown in Table 25. See Annex G for the General format of InfoFrame and InfoPackets.

Table 25. MPEG Source InfoFrame format

InfoFrame Type Code	InfoFrame Type = 05 ₁₆ (new)
InfoFrame Version Number	Version = 01 ₁₆
Length of MPEG Source InfoFrame	Length of MPEG Source InfoFrame (10)
Data Byte 1	MB#0 (MPEG Bit Rate: Hz Lower → Upper)
Data Byte 2	MB#1 =
Data Byte 3	MB#2 =
Data Byte 4	MB#3 (Upper Byte)
Data Byte 5	Rsvd Rsvd Rsvd FR0 Rsvd Rsvd MF1 MF0
Data Byte 6	Reserved (shall be 0)
Data Byte 7	Reserved (shall be 0)
Data Byte 8	Reserved (shall be 0)
Data Byte 9	Reserved (shall be 0)
Data Byte 10	Reserved (shall be 0)

Data Bytes 1-4 give the MPEG bit rate. The MPEG Bit Rate is stored as a 32-bit number and is expressed in Hertz. MB#0 contains the least significant byte while MB#3 contains the most significant byte. If the MPEG Bit Rate is unknown or this field doesn't apply, then all of the bits in Data Bytes 1-4 shall be set to 0.

Example:

10 Mbps → 10,000,000 Hz (dec.) → 0x 00 98 96 80 (hex.) Upper ,, Lower Byte

Byte 1 MB#0 0x80 Lower Byte

Byte 2 MB#1 0x96

Byte 3 MB#2 0x98

Byte 4 MB#3 0x00 Upper

MF1 and MF0 in Data Byte 5 (see Table 26) designate whether the current field/frame was generated from an I, B, or P picture from the source MPEG stream. If this is unknown or doesn't apply, then the field shall be set to "unknown."

In some cases, the source device will create 60 field/second video from 24 frames/second source material. 3:2 pulldown is commonly used. FR0 can be used to designate whether a field is a repeated field or not. The DTV Monitor can use this

information to improve the picture. If 3:2 pulldown does not apply to the current video decoding, then all of the fields/frames should be marked as “New field.”

Table 26 MPEG Source InfoFrame Data Byte 5

FR0	Field Repeat (for 3:2 pull-down)	MF1	MF0	MPEG Frame
0	New field (picture)	0	0	Unknown (No Data)
1	Repeated Field	0	1	I Picture
		1	0	B Picture
		1	1	P Picture

7 EDID Data STRUCTURE

Extended Display Identification Data (EDID) was created by VESA to enable plug and play capabilities of monitors. This data, which would be stored in the DTV Monitor, describes video formats that the DTV Monitor is capable of receiving and rendering. The information is supplied to the source device, over the interface, upon the request of the source device. The source device then chooses its output format, taking into account the format of the original video stream and the formats supported by the DTV Monitor. The source device (e.g., STB) is responsible for the format conversions necessary to supply video in an understandable form to the DTV Monitor.

The EDID content shall comply with EDID data structure version 1, revision 3 [8]. This is known as Enhanced EDID (i.e., E-EDID). The DTV Monitor shall support E-DDC [9] as the method of transporting EDID information. It is recommended that a source device be capable of using “Enhanced DDC” to access EDID information since some of the formats may be contained in extensions outside of the base 128 structure.¹⁵ However, it should be noted that for implementations based on DVI 1.0 [2] or OpenLDI [7], the source device is only required to support DDC2B. Such a device would not be able to read block 2 and up. Therefore, only non-critical information should be placed in block 2 and up.

7.1 Use of CEA EDID Timing Extensions

At the time when 861 and 861A were written, the only way to describe CEA Video formats was to use EDID 18-byte Detailed Timing Descriptors [8]. Two of the four 18-byte descriptors contained in EDID Block 0 are reserved for a Monitor Range Limits Descriptor and a Monitor Name Descriptor.¹⁶ Consequently, the E-EDID standard provides a method for including only two detailed timing descriptors. However, six DTV formats for 60 Hz systems were defined in 861 and six DTV formats for 50 Hz systems were defined in 861A. To accommodate additional detailed timing descriptors for those formats plus possibly more in the future, a CEA EDID Timing Extension has been defined. The tag (02₁₆) for this timing extension was previously reserved within VESA, but has now been assigned to CEA for the purposes of this standard. Therefore, further changes to this structure are under the control of CEA. It is referred to in this standard as the CEA EDID Timing Extension.

Three versions of the CEA Timing Extension exist. If more than one CEA Timing Extension is included in EDID, they shall all be the same version.

¹⁵ VESA has recently published a display information extension (DI-EXT) for EDID [36]. To be able to accommodate this extension and other extensions (such as the extension containing additional detailed timing descriptors), a DTV Monitor may need to use E-DDC to be able to include more than one extension. It is recommended that the source device be able to read any extension that may be included per the guidelines contained in Enhanced EDID [8].

¹⁶ The E-EDID Standard defines a tag (02₁₆) that allows for a block to be added with additional timing formats. At the time when EIA/CEA-861 was being written, the format of this “Additional Timing Data Block” was being determined by VESA. Since that time, the Tag for this timing extension has been assigned to CEA for the purposes of this standard. The information in this section is now the controlling information on this extension and is considered normative.

In addition to providing extra room for video descriptors and miscellaneous discovery information, inclusion of a specific version of the CEA EDID Timing Extension signifies to the source device what (if any) InfoFrames, Digital Audio, or $YCbCr$ Pixel formats the DTV Monitor can accept.

To maintain backward compatibility, newer versions of the CEA EDID Timing Extension include all of the fields that were present in the previous versions. Additionally, length fields are provided to let the source device know how big a block is so that it can skip over it if it doesn't understand it. All future versions of the CEA EDID Timing Extension shall have the version number incremented and shall be backward compatible with previous versions.

7.1.1 861 Implementation

The first version was created for 861 and only provides a way to supply extra EDID 18-byte Detailed Timing Descriptors.

7.1.2 Full 861A Implementation

Version 2 of the CEA Timing Extension was created for 861A. This EDID Extension also allows extra 18-byte Detailed Descriptors to be included, and additionally provides a way to designate some of the formats as "native." Version 2 also includes some miscellaneous discovery information such as the ability for the DTV Monitor to signify that it supports "Basic Audio" (details of "basic audio" are defined by the phy/link interface specification used with 861B), $YCbCr$ pixel formats, etc.

The use of CEA EDID Timing Extension Version 2 signifies to the source box that the DTV Monitor has the capability to receive and interpret the Version 1 AVI InfoFrame (see Section 6.1).

If the DTV Monitor is a Dual Aspect Ratio DTV, then it shall include Version 2 (or higher) CEA EDID Timing Extension in its EDID data structure. If a DTV Monitor supports the "Basic Audio" available on the digital interface being used, then it shall include the version 2 (or higher) CEA EDID Timing Extension with the Basic Audio bit set. If a DTV Monitor supports $YCbCr$ (in addition to RGB), then it shall include the version 2 (or higher) CEA Timing Extension with at least one of the $YCbCr$ bits set.

7.1.3 Full 861B Implementation

Version 3 is new to this standard (i.e., 861B). It includes all of the fields and capabilities of Versions 1 & 2, but also includes the ability to specify any of the CEA video formats using "CEA Short Video Descriptors." It provides the ability for the DTV Monitor to specify what types of advanced audio it supports using "CEA Short Audio Descriptors." It also provides a way for the sink device to specify its speaker configuration. This information is complementary to the speaker channel allocation information that is sent in the Audio InfoFrame.

The use of the Version 3 CEA EDID Timing Extension signifies to the source box that the DTV Monitor has the capability to receive and interpret Versions 1 and 2 of the AVI InfoFrame, Version 1 Source Product Description InfoFrame, & Version 1 MPEG Source InfoFrame. It also signifies to the source box that the DTV Monitor can receive

the Audio InfoFrame. The ability to interpret the audio identification information in the Audio InfoFrame is indicated by the DTV Monitor's support of advanced audio (audio other than "basic audio"). The DTV Monitor's ability to act upon the speaker allocation information contained in the Audio InfoFrame is indicated by its support of multi-channel LPCM (i.e., more than two channels) in EDID.

If a DTV Monitor supports any of the new 861B video formats or digital audio other than what is defined as "basic audio," then it shall include the version 3 (or higher) CEA EDID Timing Extension in its EDID data structure. If the DTV Monitor supports any type of digital audio on this interface, then it shall also support Basic Audio (see Section 2.4) and shall indicate this by setting the Basic Audio bit in the CEA EDID Timing Extension. If the DTV Monitor supports multi-channel LPCM (i.e., more than two channels), then it shall include the Speaker Allocation Data Block in the CEA EDID Timing Extension. It is recommended that the DTV Monitor include a valid Speaker Allocation Data Block if it supports any type of digital audio on the interface, but this is not required.

7.2 Describing Video Formats in EDID

Two methods of describing video formats are used in the various 861 implementations (18-byte Detailed Timing Descriptors and CE Short Video Descriptors which are new in 861B).

7.2.1 861 and 861A Implementations

For 861 and 861A implementations, all of the CEA video formats listed in E-EDID are described using 18-byte Detailed Timing Descriptors. As stated in Section 7.1, there is only room for two 18-byte Detailed Timing Descriptors in EDID Block 0.

The CEA EDID Timing Extension shall be used to include any additional 18-byte detailed timing descriptors needed to describe the formats from this standard that the DTV Monitor supports.

Therefore, for 861 and 861A implementations, the DTV Monitor shall enumerate all of the DTV formats that it supports in EDID block 0 and in the CEA EDID Timing Extension. Consistent with other applications, it is not necessary to enumerate 640X480 since that format is required to be supported in all cases.

7.2.2 Full 861B Implementation

If a Version 3 CEA Timing Extension has been included in EDID, all CEA video formats shall be advertised using Short Video Descriptors, even if they are also required to be advertised using the 18-byte Detailed Timing Descriptors (see below).

Even though short descriptors are now available in the Version 3 CEA Timing Extension, there are still requirements to use 18-byte Detailed Timing Descriptors in some cases to maintain backward compatibility with the previous versions of 861. The required 861/861A formats shall continue to be advertised using the EDID 18-byte Detailed Timing Descriptors (for backward compatibility). The optional 861A formats (i.e., 480i and 576i) should be advertised in an EDID 18-byte Detailed Timing Descriptor (for backward compatibility), but this is not required. The optional formats from 861A

(720X480i, 720X576i) can be advertised using only Short Video Descriptors at the option of the DTV Monitor designer.

7.2.3 Use of EDID 18-byte Detailed Timing Descriptors

For the purposes of this standard, a DTV Monitor intended for 60 Hz countries shall support both the 60 Hz and 59.94 Hz version of any format it supports. The 60 Hz version shall be described in the EDID structure for HDTV formats, the 59.94Hz version shall be described for all 480-line formats.

The “preferred” timing format shall be described in the first 18-byte “detailed timing descriptor” and shall include the primary aspect ratio of the DTV Monitor.

Note that the EDID 18-byte detailed timing descriptor allows for the designation of an interlaced format. However, there are no provisions to specify separate vertical blanking/sync for Field 1 and Field 2. Therefore, for the purposes of this standard, the following rules apply for interlaced formats:

1. The Field 1 Vertical Blanking Interval shall equal the Vertical Blanking Lines in the Detailed Timing Descriptor.
2. The Field 2 Vertical Blanking Interval shall equal the Vertical Blanking Lines in the Detailed Timing Descriptor + 1.
3. The Field 1 Vertical Sync Offset shall equal the Vertical Sync Offset in the Detailed Timing Descriptor.
4. The Field 2 Vertical Sync Offset shall equal the Vertical Sync Offset in the Detailed Timing Descriptor + 1/2.

Different EDID 18-byte Detailed Timing Descriptors are required for video formats with different picture aspect ratios. The vertical and horizontal image size parameters shall contain numbers that describe the aspect ratio of the displayed video (actual dimensions are preferred, but not required). It is anticipated that there will be two cases: either 4:3 or 16:9.

Examples of EDID 18-byte Detailed Timing Descriptors for the 861 and 861A CEA video formats are contained in Annex A.

7.2.4 Order of 18-byte Detailed Timing Descriptors (Backward Compatibility with 861)

As explained in Section 4.1, a DTV Monitor compliant with EIA/CEA-861 could support only one picture aspect ratio of a basic format (i.e, 720X480p, 720X480i, 720X576p, and 720X576i) at a time. Now that a method of sending picture aspect ratio information from the source to the DTV Monitor has been standardized, it is possible that source devices will encounter 18-byte Detailed Timing Descriptors for both picture aspect ratios within a single DTV Monitor. To allow for this possibility, it was previously recommended that source devices consider the first occurrence of the format in the EDID data structure (e.g., 4:3) to be the format that would be displayed in the absence of aspect ratio information being carried from the source to display. For backward compatibility to these source devices, the EDID data structure of a DTV Monitor shall place the descriptor for the video format with the preferred picture aspect ratio (the one

that will be displayed if no aspect ratio information is received from the source device) before the descriptor for the video format with the other picture aspect ratio (when the two video formats use the same video format timing). Following these practices allows source devices compliant with EIA/CEA-861 to unambiguously send video data of a specific aspect ratio to a DTV Monitor that supports video formats available in multiple aspect ratios as described in this standard.

New source devices must also handle the situation of a DTV Monitor that is compliant with EIA/CEA-861 that does not support Aspect Ratio Indication (i.e., the reception of the AVI InfoFrame). In that case, the DTV Monitor only supports one of these two formats at a time as described in Section 4.1. The supported format would be advertised in the EDID data structure.

7.2.5 Source Device Guidance

If the DTV Monitor has provided a timing descriptor for a particular video format decoded in the source, it is recommended that the source send video across the interface without performing format conversion. If a conversion must be done, it is recommended that the conversion be to a format identified by the display as a 'native format' as explained in Section 7.4 and Section 7.5. Examples of different conversion processes are illustrated in Annex F.

If EDID can't be read correctly by the source device (perhaps cable is too long), then the source device may use 640X480p (default) since this format is required to be supported by the DTV Monitor in this standard and the general phy/link interface standards that can be used with this standard (see Section 3.1). If the source device can determine that the sink device is 861-compliant, then it may supply 720X480p since support for this format timing is required in all 861-compliant DTV Monitors. If the source device can determine the preferred picture aspect ratio for the 720X480p format, then it should use that picture aspect ratio.

7.3 CEA EDID Timing Extension Version 1

The first version was created for 861 and only provides a way to supply extra EDID 18-byte Detailed Timing Descriptors.

The following EDID Extension follows the format described in Section 2.2.1.3 of [8]. The EDID Extension Tag for this extension shall be 02h. VESA has given control of the definition of this extension to CEA for the purposes of this standard. As with EIA/CEA-861 [22], the first format listed in the base EDID data structure is the preferred format.

Table 27. CEA EDID Timing Extension Version 1 (originally defined in 861)

Byte #	Value	Description	Format
0	02h	Tag (02h)	
1	01h	Revision Number	
2		Byte number offset d where Detailed Timing data begins	d = offset for the byte following the reserved data block. If no data is provided in the reserved data block, then $d=4$. If no detailed timing descriptions are provided then $d=0$.
3		Reserved	Set to 00h
4		Start reserved data block	This section was previously reserved for 8 byte timing descriptors (See [22]) but is currently a reserved data block.
$d-1$		End of reserved data block.	
d		Start of 18-byte detailed timing descriptions	See Section 3.10.2 of [8]
$d+(18Xn)-1$		End of 18-byte detailed timing descriptions where n is the number of descriptors included	
$d+(18Xn)$	00h	Beginning of Padding	
126	00h	End of Padding	
127		Checksum	xxh = This byte should be programmed such that a one-byte checksum (add all bytes together) of the entire 128 byte block equals "00h".

7.4 CEA EDID Timing Extension Version 2

Version 2 of the CEA Timing Extension was created for 861A. This EDID Extension also allows extra 18-byte Detailed Descriptors to be included, and additionally provides a way to designate some of the formats as "native." Version 2 also includes some miscellaneous discovery information such as the ability for the DTV Monitor to signify that it supports "Basic Audio" ("basic audio" is defined by the interface specification used with 861B), $YC_B C_R$ pixel formats, etc.

Version 2 of the CEA Timing Extension (Table 28) contains a field for designating the number of native formats supported by the DTV Monitor. As with EIA/CEA-861 [22], the first format listed in the base EDID data structure is the preferred format. Other native formats should be listed consecutively after that format. The new field consists of the count of the number of timing descriptors, starting with any listed in the base 128 EDID data structure and continuing with those listed in the extension blocks, that are to be considered "native" timings (see Section 7.2.5). If more than one timing extension is needed, then the value shall be the same in all extensions. Value zero means that this information is not provided (for backward compatibility with EIA/CEA-861). Format Timings should not be repeated within a timing extension. Timing extensions shall be included to provide timing descriptors for all supported formats. The last timing extension may contain less than six 18-byte descriptors. All other timing extensions that contain detailed timing descriptors shall contain six 18-byte descriptors.

Table 28. CEA EDID Timing Extension Version 2 (originally defined in 861A)

Byte #	Value	Description	Format
0	02h	Tag (02h)	
1	02h	Revision Number	
2		Byte number offset <i>d</i> where Detailed Timing data begins	<i>d</i> = offset for the byte following the reserved data block. If no data is provided in the reserved data block, then <i>d</i> =4. If <i>d</i> =0, then no detailed timing descriptors are provided and no data is provided in the reserved data block.
3		Total number of native (preferred) formats described by 18 byte detailed timing descriptors in entire E-EDID structure. Also, indication of underscan support, audio support, and support of YC _B C _R is included	bit 7 (underscan) = 1 if DTV Monitor supports underscan. bit 6 (audio) = 1 if DTV Monitor supports basic audio bit 5 (YC _B C _R 4:4:4) = 1 if DTV Monitor supports YC _B C _R 4:4:4 in addition to RGB bit 4 (YC _B C _R 4:2:2) = 1 if DTV Monitor supports YC _B C _R 4:2:2 in addition to RGB lower 4 bits = total number of native formats.
4		Start reserved data block	This section was previously reserved for 8 byte timing descriptors ¹⁷ (See [22]) but is currently a reserved data block.
<i>d</i> -1		End of reserved data block.	
<i>d</i>		Start of 18-byte detailed timing descriptions	See Section 3.10.2 of [8]
<i>d</i> +(18X <i>n</i>)-1		End of 18-byte detailed timing descriptions where <i>n</i> is the number of descriptors included	
<i>d</i> +(18X <i>n</i>)	00h	Beginning of Padding	
126	00h	End of Padding	
127		Checksum	xxh = This byte should be programmed such that a one-byte checksum (add all bytes together) of the entire 128 byte block equals "00h".

7.5 CEA EDID Timing Extension Version 3

Version 3 is new to this standard (i.e., 861B). It includes all of the capabilities of Versions 1 & 2, but also includes the ability to specify any of the CEA formats using "CEA Short Video Descriptors." It provides the ability for the DTV Monitor to specify what types of advanced audio it supports using "CEA Short Audio Descriptors." It also provides a way for the sink device to specify its speaker configuration. This information

¹⁷ The 8-byte descriptors do not support the DTV formats defined in this standard since they are not compliant with VESA GTF [38].

is complementary to the speaker channel allocation information that is sent in the Audio InfoFrame.

Version 3 of the CEA EDID Timing Extension includes all of the indications contained in CEA EDID Timing Extension Version 2 including the field that designates the number of native formats described using 18-byte detailed descriptors. The use of this field is the same as in Version 2 of the CEA EDID Timing Extension.

Additionally, the Version 3 CEA EDID Timing Extension can include Short Video Descriptors for advertising the video formats defined in this standard and it can include Short Audio Descriptors for describing support of advanced audio formats (compressed and uncompressed). These descriptors are contained in data blocks identified by "Tags." Support of "basic audio" shall still be advertised using the basic audio bit. The DTV Monitor is required to support Basic Audio if it supports digital audio on this interface. The details of "basic audio" are defined by the interface specification used with 861B (see Section 2.4).

Version 3 of the CEA EDID Timing Extension can also include a Speaker Allocation Data Block. This data block contains information on the sink device's speaker configuration. This information is required if the sink device supports multi-channel LPCM digital audio as described using CEA Short Audio Descriptors.

Version 3 of the CEA EDID Timing Extension can also include a Vendor Specific Data Block. This data block can be used to include information not specifically defined in this standard. The format of this descriptor is determined by the owner of the Registration ID used at that beginning of the block. Any number of these data blocks (barring other restrictions) may be present in the CEA EDID Timing Extension Version 3.

CEA EDID Timing Extension Version 3 is shown below in Table 29:

Table 29. CEA EDID Timing Extension Version 3 (new in 861B)

Byte #	Value	Description	Format
0	02h	Tag (02h)	
1	03h	Revision Number	
2		Byte number offset d where Detailed Timing data begins	d = offset for the byte following the reserved data block. If no data is provided in the reserved data block, then $d=4$. If $d=0$, then no detailed timing descriptors are provided and no data is provided in the reserved data block.
3		Total number of native (preferred) formats described by 18 byte detailed timing descriptors in entire E-EDID structure. Also, indication of underscan support, audio support, and support of $YC_B C_R$ is included	bit 7 (underscan) = 1 if DTV Monitor supports underscan. bit 6 (audio) = 1 if DTV Monitor supports basic audio bit 5 ($YC_B C_R$ 4:4:4) = 1 if DTV Monitor supports $YC_B C_R$ 4:4:4 in addition to RGB bit 4 ($YC_B C_R$ 4:2:2) = 1 if DTV Monitor supports $YC_B C_R$ 4:2:2 in addition to RGB lower 4 bits = total number of native formats described using 18-byte detailed timing descriptors.
4		Start of data block collection	This section was previously reserved for 8 byte timing descriptors ¹⁸ (See [22]) but is currently used for CEA Data Block Collection (see Table 30).
$d-1$		End of data block collection.	
d		Start of 18-byte detailed timing descriptions	See Section 3.10.2 of [8]
$d+(18Xn)-1$		End of 18-byte detailed timing descriptions where n is the number of descriptors included	
$d+(18Xn)$	00h	Beginning of Padding	
126	00h	End of Padding	
127		Checksum	xxh = This byte should be programmed such that a one-byte checksum (add all bytes together) of the entire 128 byte block equals "00h".

Audio and Video Data Blocks shall contain Short Descriptors to indicate the support of optional capabilities not listed in other sections of EDID. Examples of the optional capabilities are support of various audio and video formats included in this standard (see Table 13 and Table 19).

For backward compatibility with EIA/CEA-861, video formats defined in 861 and 861A (see Table 13), except for the optional 480i and 576i formats, shall be listed as full 18-byte structures per the rules presented in Section 7.2.2. The 480i and 576i formats should be listed in EDID 18-byte structures for backward compatibility. Additionally, all formats defined in this standard (including the 861 and 861A formats) shall be listed

¹⁸ The 8-byte descriptors do not support the DTV formats defined in this standard since they are not compliant with VESA GTF [38].

using short video descriptors if the Version 3 CEA EDID Timing Extension is included in the DTV Monitor’s EDID data structure.

The format of the “CEA Data Block Collection” shall conform to that shown in Table 30. Note that the order of the Data Blocks is not constrained. It is also possible to have more than one of a specific type of data block if necessary to include all of the descriptors needed to describe the DTV Monitor’s capabilities. The header of a Data Block consists of one byte, with 3 bits used for the tag code to label the type of data and 5 bits used to indicate the length of the block (Table 31). Four of the possible seven tags have been defined: for audio, video, speaker allocation, and vendor specific. The list of tag codes is shown in Table 32.

Table 30. General Format of “CEA Data Block Collection”

	Byte#	Bits 5-7	Bits 0-4
Video Data Block	1	Video Tag Code	length=total number of video bytes following this byte (L_1)
	2	CEA Short Video Descriptor 1	
	3	CEA Short Video Descriptor 2	
	
	$1+L_1$	CEA Short Video Descriptor L_1	
Audio Data Block	$2+L_1$	Audio Tag Code	length=total number of audio bytes following this byte (L_2)
	$3+L_1$	CEA Short Audio Descriptor 1	
	$4+L_1$		
	$5+L_1$		
	...	CEA Short Audio Descriptor $L_2/3$	
	...		
	L_1+L_2		
	$1+L_1+L_2$	CEA Short Audio Descriptor $L_2/3$	
	$2+L_1+L_2$		
Speaker Allocation Data Block	$3+L_1+L_2$	Speaker Allocation Tag Code	length=total number of speaker allocation bytes following this byte ($L_3=3$)
	$4+L_1+L_2$	Speaker Allocation Data Block Payload (3 bytes)	
	$5+L_1+L_2$		
	$6+L_1+L_2$		
Vendor Specific Data Block	$7+L_1+L_2$	Vendor Specific Tag Code	length=total number of vendor specific bytes following this byte (L_4)
	$8+L_1+L_2$	24-bit IEEE Registration Identifier (least significant byte first)	
	$9+L_1+L_2$		
	$10+L_1+L_2$		
	Vendor Specific Data Block Payload (L_4-3 bytes)	
.....			

The General Tag format is shown in Table 31. The first three bits are a Tag Code. This tag code designates the format of the bytes that follow. The last five bits are a length field that designates the number of bytes in the data block associated with the tag. The number of bytes does not include the tag. In the case of a video data block or

an audio data block, the data block consists of a number of short descriptors. For other data blocks, the format may be different (e.g., Speaker Allocation Data Block). However, the length is always the number of bytes following the tag.

Table 31. General Tag Format

Byte#	bits							
	7	6	5	4	3	2	1	0
1	Tag Code			Length of following data block payload (in bytes)				

Table 32. CEA Data Block Tag Codes

Codes	Type of Data Block
0	Reserved
1	Audio Data Block (includes one or more Short Audio Descriptors)
2	Video Data Block (includes one or more Short Video Descriptors)
3	Vendor Specific Data Block
4	Speaker Allocation Data Block
5	Reserved
6	Reserved
7	Reserved

If audio is supported in the DTV Monitor, as indicated by the basic audio support bit in the Version 3 CEA EDID Timing Descriptor, then CEA short audio descriptors shall be used to declare which (if any) audio formats are supported in addition to basic audio. If only basic audio is supported, no Short Audio Descriptors are necessary.

The Short Audio Descriptor shall conform to the formats given in Table 33 and Table 34. Several types of audio may be supported, but each one must be listed in its own short audio descriptor with its designated code and the associated information. The list of audio coding types is given in Table 35.

There are two versions of Short Audio Descriptors. Each Short Audio Descriptor is 3-bytes long. There can be up to 32 bytes following any tag, therefore there may be up to 10 Short Audio Descriptors in the Audio Data Block.

The format of the third byte is determined by the audio format code contained in the first byte. One is used for uncompressed audio (i.e., Linear PCM), the other is used for compressed audio (i.e., AC-3, MPEG1, MP3, MPEG2, AAC, DTS, and ATRAC). The CEA Short Audio Descriptor are shown in Table 33 and Table 34.

Table 33. CEA Short Audio Descriptor for uncompressed audio

Byte#	bits							
	7	6	5	4	3	2	1	0
1	Rsvd	Audio Format Code = 0001				Max Number of channels - 1		
2	Rsvd	192KHz	176KHz	96KHz	88KHz	48kHz	44KHz	32KHz
3	Reserved (shall be 0)					24 bit	20 bit	16 bit

Table 34. CEA Short Audio Descriptor for compressed audio

Byte#	bits							
	7	6	5	4	3	2	1	0
1	Rsvd	Audio Format Code				Max Number of channels - 1		
2	Rsvd	192KHz	176KHz	96KHz	88KHz	48kHz	44KHz	32KHz
3	Maximum bit rate divided by 8 kHz.							

The Audio Format Codes used in each Short Audio Descriptor are shown below in Table 35. These values are the same as the values used in the Audio InfoFrame, which are shown in Table 19.

Table 35. Audio Format Codes

Codes	Audio Format Description
0	Reserved
1	Linear PCM (e.g., IEC60958)
2	AC-3
3	MPEG1 (Layers 1 & 2)
4	MP3 (MPEG1 Layer 3)
5	MPEG2 (multichannel)
6	AAC
7	DTS
8	ATRAC
9	Reserved for audio format 9
....	
14	Reserved for audio format 14
15	Reserved

Some information on typical audio applications is contained in Informative ANNEX J.

If the DTV Monitor supports multi-channel LPCM digital audio as described in the Audio Data Block, then the Speaker Allocation Data Block shall be included in the CEA EDID Timing Extension. It is recommended that the DTV Monitor include a valid Speaker Allocation Data Block if it supports any type of digital audio (including Basic Audio), but this is not required.

The payload of the Speaker Allocation Data Block is shown in Table 36. Note that in the Data Collection Block, this payload is preceded by a Tag Code Byte that includes a tag equal to four and a length of three (see Table 30). The first byte of the Data block payload consists of seven bits and one reserved bit. The DTV Monitor signifies that a speaker, or pair of speakers, is present by setting the bit associated with that speaker or pair of speakers to one. The speaker designations are the same as is used in the Audio InfoFrame (see Figure 24 and Table 21). The Front Left and Front Right channels are not independent and are shown as FL/FR in the table. The Front Left Center and Front Right Center (FLC/FRC) Rear Left and Rear Right (RL/RR), and Rear Left Center and Rear Right Center (RLC/RRC) channels are also not independent.

Table 36 Speaker Allocation Data Block Payload

		bits						
Byte#	7	6	5	4	3	2	1	0
1	Rsvd	RLC/ RRC	FLC/ FRC	RC	RL/ RR	FC	LFE	FL/ FR
2	Reserved (shall be 0)							
3	Reserved (shall be 0)							

When a Version 3 CEA Timing Extension is provided in the DTV Monitor’s EDID data structure, a short video descriptor shall be provided for each CEA video format supported by the DTV Monitor. The format of the short video descriptor shall conform to that shown in Table 37. The lower 7-bits are an index associated with the video format supported. These indexes are the same as those used in the AVI InfoFrame and are shown in Table 13. The first bit declares if the format is a native format of the display (native =1, not native = 0). The rules regarding how to handle formats marked as native apply (see Section 7.2.5).

Table 37. CEA Short Video Descriptor

		bits						
Byte#	7	6	5	4	3	2	1	0
1	Native	Video Identification Code						

ANNEX A: EXAMPLE EDID 18-Byte Detailed Timing Descriptors (Informative)

Table 38. Example EDID Detailed Timing Descriptor for 1280X720p (60 Hz, 16:9)

Byte# (HEX)	Function	Value (HEX)	Value (binary)	Notes
36	Pixel Clock/10,000 (LSB stored first)	01		Pixel Clock = 74.25MHz
37		1D		
38	Horizontal Active Pixels (lower 8 bits)	00		hor. active pixels = 1280 = 500h
39	Horizontal Blanking Pixels (lower 8 bits)	72		hor. blanking pixels = 370 = 172h
3A	Horizontal Active and Blanking Pixels (upper nibble = upper 4 bits of active) (lower nibble = upper 4 bits of blanking)	51		
3B	Vertical Active Lines, lower 8 bits	D0		vert. active lines = 720 = 2D0h
3C	Vertical Blanking Lines, lower 8 bits	1E		vert. blanking lines = 30 = 1Eh
3D	Vertical Active: Vertical Blanking (upper nibble = upper 4 bits of active) (lower nibble = upper 4 bits of blanking)	20		
3E	Horizontal sync. offset (pixels) (from blanking starts, lower 8 bits)	6E		offset = 110 pixels = 6Eh
3F	Horizontal sync pulse width (pixels) (lower 8 bits)	28		width = 40 pixels = 28h
40	Vert sync offset; Vert sync pulse width (upper nibble = lines, lower 4 bits of vertical sync offset) (lower nibble = lines, lower 4 bits of vertical sync pulse width)	55		vert sync. offset = 5 lines vert. sync width = 5 lines
41	bits 7,6: upper 2 bits of Hor. sync. offset bits 5,4: upper 2 bits of Hor. sync pulse width bits 3,2: upper 2 bits of vert sync offset bits 1,0: upper 2 bits of vert. sync pulse width	00	00000000	
42	Horizontal Image Size (mm, lower 8 bits)	C4		Hor. Image size = 708mm = 2C4h
43	Vertical Image Size (mm, lower 8 bits)	8E		Vert. Image Size = 398mm = 18Eh
44	Horizontal and Vertical Image Size (upper nibble = upper 4 bits of horiz.) (lower nibble = upper 4 bits of vert.)	21		
45	Horizontal Border ¹⁹ (pixels)	0		Must be 0
46	Vertical Border (pixels)	0		Must be 0
47	Flags (bit 7 = non-interlaced; bit 5,6 = normal display; bit 1, 2, 3,4 = sync description; bit 0 = don't care)	1E	00011110	Flag = non- interlaced; non-stereo; digital separate; positive V sync; positive H sync

¹⁹ A border is the portion of the display screen that is outside the addressable area of the display device screen; or the portion of the video signal that is not intended to be driven or scanned, when sent to a display electronics [8]. Borders are part of the blanking time. For CE products, border will not be used and in the 18 byte detailed timing descriptor, the horizontal and vertical borders shall be set to zero.

Table 39. Example EDID Detailed Timing Descriptor for 1920X1080i (60 Hz, 16:9)

Byte# (HEX)	Function	Value (HEX)	Value (binary)	Notes
36	Pixel Clock/10,000 (LSB stored first)	01		Pixel Clock = 74.25MHz
37		1D		
38	Horizontal Active Pixels (lower 8 bits)	80		hor. active pixels = 1920 = 780h
39	Horizontal Blanking Pixels (lower 8 bits)	18		hor. blanking pixels = 280 = 118h
3A	Horizontal Active and Blanking Pixels (upper nibble = upper 4 bits of active) (lower nibble = upper 4 bits of blanking)	71		
3B	Vertical Active Lines, lower 8 bits	1C		vert. active lines = 540 = 21Ch
3C	Vertical Blanking Lines, lower 8 bits	16		vert. blanking lines = 22 = 16h ²⁰
3D	Vertical Active: Vertical Blanking (upper nibble = upper 4 bits of active) (lower nibble = upper 4 bits of blanking)	20		
3E	Horizontal sync. offset (pixels) (from blanking starts, lower 8 bits)	58		offset = 88 pixels = 58h
3F	Horizontal sync pulse width (pixels) (lower 8 bits)	2C		width = 44 pixels = 2Ch
40	Vert sync offset; Vert sync pulse width (upper nibble = lines, lower 4 bits of vertical sync offset) (lower nibble = lines, lower 4 bits of vertical sync pulse width)	25		vert sync. offset = 2 lines ²¹ vert. sync width = 5 lines
41	bits 7,6: upper 2 bits of Hor. sync. offset bits 5,4: upper 2 bits of Hor. sync pulse width bits 3,2: upper 2 bits of vert sync offset bits 1,0: upper 2 bits of vert. sync pulse width	00	00000000	
42	Horizontal Image Size (mm, lower 8 bits)	C4		Hor. Image size = 708mm = 2C4h ²²
43	Vertical Image Size (mm, lower 8 bits)	8E		Vert. Image Size = 398mm = 18Eh
44	Horizontal and Vertical Image Size (upper nibble = upper 4 bits of horiz.) (lower nibble = upper 4 bits of vert.)	21		
45	Horizontal Border (pixels)	0		Must be 0
46	Vertical Border (pixels)	0		Must be 0
47	Flags (bit 7 = interlaced; bit 5,6 = normal display; bit 1, 2, 3,4 = sync description; bit 0 = don't care)	9E	10011110	Flag = interlaced; non-stereo; digital separate; positive V sync; positive H sync

²⁰ For interlaced display: Field 1 vertical blanking = Vertical Blanking Lines. Field 2 vertical blanking = Vertical Blanking Lines + 1 line.

²¹ For interlaced display: Field 1 vertical offset = Vertical Sync Offset. Field 2 vertical offset = Vertical Sync Offset + 0.5 lines.

²² Image size is display dependent. Ratio of Horizontal Image Size to Vertical Image Size shall be 16:9 or 4:3.

Table 40. Example EDID Detailed Timing Descriptor for 720x480p (59.94Hz, 4:3)

Byte# (HEX)	Function	Value (HEX)	Value (binary)	Notes
36	Pixel Clock/10,000 (LSB stored first)	8C		Pixel Clock = 27.00MHz
37		0A		
38	Horizontal Active Pixels (lower 8 bits)	D0		hor. active pixels = 720 = 2D0h
39	Horizontal Blanking Pixels (lower 8 bits)	8A		hor. blanking pixels = 138 = 8Ah
3A	Horizontal Active and Blanking Pixels (upper nibble = upper 4 bits of active) (lower nibble = upper 4 bits of blanking)	20		
3B	Vertical Active Lines, lower 8 bits	E0		vert. active lines = 480 = 1E0h
3C	Vertical Blanking Lines, lower 8 bits	2D		vert. blanking lines = 45 = 2Dh
3D	Vertical Active: Vertical Blanking (upper nibble = upper 4 bits of active) (lower nibble = upper 4 bits of blanking)	10		
3E	Horizontal sync. offset (pixels) (from blanking starts, lower 8 bits)	10		offset = 16 pixels = 10h
3F	Horizontal sync pulse width (pixels) (lower 8 bits)	3E		width = 62 pixels = 3Eh
40	Vert sync offset; Vert sync pulse width (upper nibble = lines, lower 4 bits of vertical sync offset) (lower nibble = lines, lower 4 bits of vertical sync pulse width)	96		vert sync. offset = 9 lines vert. sync width = 6 lines
41	bits 7,6: upper 2 bits of Hor. sync. offset bits 5,4: upper 2 bits of Hor. sync pulse width bits 3,2: upper 2 bits of vert sync offset bits 1,0: upper 2 bits of vert. sync pulse width	00	00000000	
42	Horizontal Image Size (mm, lower 8 bits)	13		Hor. Image size = 531mm = 213h
43	Vertical Image Size (mm, lower 8 bits)	8E		Vert. Image Size = 398mm = 18Eh (4:3 in this case).
44	Horizontal and Vertical Image Size (upper nibble = upper 4 bits of horiz.) (lower nibble = upper 4 bits of vert.)	21		
45	Horizontal Border (pixels)	0		Must be 0
46	Vertical Border (pixels)	0		Must be 0
47	Flags (bit 7 = non-interlaced; bit 5,6 = normal display; bit 1, 2, 3,4 = sync description; bit 0 = don't care)	18	00011000	Flag = non-interlaced; non-stereo; digital separate; negative V sync; negative H sync

Table 41. Example EDID Detailed Timing Descriptor for 720x480p (59.94Hz, 16:9)

Byte# (HEX)	Function	Value (HEX)	Value (binary)	Notes
36	Pixel Clock/10,000 (LSB stored first)	8C		Pixel Clock = 27.00MHz
37		0A		
38	Horizontal Active Pixels (lower 8 bits)	D0		hor. active pixels = 720 = 2D0h
39	Horizontal Blanking Pixels (lower 8 bits)	8A		hor. blanking pixels = 138 = 8Ah
3A	Horizontal Active and Blanking Pixels (upper nibble = upper 4 bits of active) (lower nibble = upper 4 bits of blanking)	20		
3B	Vertical Active Lines, lower 8 bits	E0		vert. active lines = 480 = 1E0h
3C	Vertical Blanking Lines, lower 8 bits	2D		vert. blanking lines = 45 = 2Dh
3D	Vertical Active: Vertical Blanking (upper nibble = upper 4 bits of active) (lower nibble = upper 4 bits of blanking)	10		
3E	Horizontal sync. offset (pixels) (from blanking starts, lower 8 bits)	10		offset = 16 pixels = 10h
3F	Horizontal sync pulse width (pixels) (lower 8 bits)	3E		width = 62 pixels = 3Eh
40	Vert sync offset; Vert sync pulse width (upper nibble = lines, lower 4 bits of vertical sync offset) (lower nibble = lines, lower 4 bits of vertical sync pulse width)	96		vert sync. offset = 9 lines vert. sync width = 6 lines
41	bits 7,6: upper 2 bits of Hor. sync. offset bits 5,4: upper 2 bits of Hor. sync pulse width bits 3,2: upper 2 bits of vert sync offset bits 1,0: upper 2 bits of vert. sync pulse width	00	00000000	
42	Horizontal Image Size (mm, lower 8 bits)	C4		Hor. Image size = 708mm = 2C4h
43	Vertical Image Size (mm, lower 8 bits)	8E		Vert. Image Size = 398mm = 18Eh (16:9 in this case).
44	Horizontal and Vertical Image Size (upper nibble = upper 4 bits of horiz.) (lower nibble = upper 4 bits of vert.)	21		
45	Horizontal Border (pixels)	0		Must be 0
46	Vertical Border (pixels)	0		Must be 0
47	Flags (bit 7 = non-interlaced; bit 5,6 = normal display; bit 1, 2, 3,4 = sync description; bit 0 = don't care)	18	00011000	Flag = non-interlaced; non-stereo; digital separate; negative V sync; negative H sync

Table 42. Example EDID Detailed Timing Descriptor for 720x480i (59.94Hz, 4:3)

Byte# (HEX)	Function	Value (HEX)	Value (binary)	Notes
36	Pixel Clock/10,000 (LSB stored first)	8C		Pixel Clock = 27.00MHz
37		0A		
38	Horizontal Active Pixels (lower 8 bits)	A0		hor. active pixels = 1440 = 5A0h
39	Horizontal Blanking Pixels (lower 8 bits)	14		hor. blanking pixels = 276 = 114h
3A	Horizontal Active and Blanking Pixels (upper nibble = upper 4 bits of active) (lower nibble = upper 4 bits of blanking)	51		
3B	Vertical Active Lines, lower 8 bits	F0		vert. active lines = 240 = F0h
3C	Vertical Blanking Lines, lower 8 bits	16		vert. blanking lines = 22 = 16h
3D	Vertical Active: Vertical Blanking (upper nibble = upper 4 bits of active) (lower nibble = upper 4 bits of blanking)	00		
3E	Horizontal sync. offset (pixels) (from blanking starts, lower 8 bits)	26		offset = 38 pixels = 26h
3F	Horizontal sync pulse width (pixels) (lower 8 bits)	7C		width = 124 pixels = 7Ch
40	Vert sync offset; Vert sync pulse width (upper nibble = lines, lower 4 bits of vertical sync offset) (lower nibble = lines, lower 4 bits of vertical sync pulse width)	43		vert sync. offset = 4 lines vert. sync width = 3 lines
41	bits 7,6: upper 2 bits of Hor. sync. offset bits 5,4: upper 2 bits of Hor. sync pulse width bits 3,2: upper 2 bits of vert sync offset bits 1,0: upper 2 bits of vert. sync pulse width	00	00000000	
42	Horizontal Image Size (mm, lower 8 bits)	13		Hor. Image size = 531mm = 213h
43	Vertical Image Size (mm, lower 8 bits)	8E		Vert. Image Size = 398mm = 18Eh (4:3 in this case).
44	Horizontal and Vertical Image Size (upper nibble = upper 4 bits of horiz.) (lower nibble = upper 4 bits of vert.)	21		
45	Horizontal Border (pixels)	0		Must be 0
46	Vertical Border (pixels)	0		Must be 0
47	Flags (bit 7 = non-interlaced; bit 5,6 = normal display; bit 1, 2, 3,4 = sync description; bit 0 = don't care)	98	10011000	Flag = interlaced; non-stereo; digital separate; negative V sync; negative H sync

Table 43. Example EDID Detailed Timing Descriptor for 720x480i (59.94Hz, 16:9)

Byte# (HEX)	Function	Value (HEX)	Value (binary)	Notes
36	Pixel Clock/10,000 (LSB stored first)	8C		Pixel Clock = 27.00MHz
37		0A		
38	Horizontal Active Pixels (lower 8 bits)	A0		hor. active pixels = 1440 = 5A0h
39	Horizontal Blanking Pixels (lower 8 bits)	14		hor. blanking pixels = 276 = 114h
3A	Horizontal Active and Blanking Pixels (upper nibble = upper 4 bits of active) (lower nibble = upper 4 bits of blanking)	51		
3B	Vertical Active Lines, lower 8 bits	F0		vert. active lines = 240 = F0h
3C	Vertical Blanking Lines, lower 8 bits	16		vert. blanking lines = 22 = 16h
3D	Vertical Active: Vertical Blanking (upper nibble = upper 4 bits of active) (lower nibble = upper 4 bits of blanking)	00		
3E	Horizontal sync. offset (pixels) (from blanking starts, lower 8 bits)	26		offset = 38 pixels = 26h
3F	Horizontal sync pulse width (pixels) (lower 8 bits)	7C		width = 124 pixels = 7Ch
40	Vert sync offset; Vert sync pulse width (upper nibble = lines, lower 4 bits of vertical sync offset) (lower nibble = lines, lower 4 bits of vertical sync pulse width)	43		vert sync. offset = 4 lines vert. sync width = 3 lines
41	bits 7,6: upper 2 bits of Hor. sync. offset bits 5,4: upper 2 bits of Hor. sync pulse width bits 3,2: upper 2 bits of vert sync offset bits 1,0: upper 2 bits of vert. sync pulse width	00	00000000	
42	Horizontal Image Size (mm, lower 8 bits)	C4		Hor. Image size = 708mm = 2C4h
43	Vertical Image Size (mm, lower 8 bits)	8E		Vert. Image Size = 398mm = 18Eh (16:9 in this case).
44	Horizontal and Vertical Image Size (upper nibble = upper 4 bits of horiz.) (lower nibble = upper 4 bits of vert.)	21		
45	Horizontal Border (pixels)	0		Must be 0
46	Vertical Border (pixels)	0		Must be 0
47	Flags (bit 7 = non-interlaced; bit 5,6 = normal display; bit 1, 2, 3,4 = sync description; bit 0 = don't care)	98	10011000	Flag = interlaced; non-stereo; digital separate; negative V sync; negative H sync

Table 44. Example EDID Detailed Timing Descriptor for 1280X720p (50 Hz, 16:9)

Byte# (HEX)	Function	Value (HEX)	Value (binary)	Notes
36	Pixel Clock/10,000 (LSB stored first)	01		Pixel Clock = 74.25MHz
37		1D		
38	Horizontal Active Pixels (lower 8 bits)	00		hor. active pixels = 1280 = 500h
39	Horizontal Blanking Pixels (lower 8 bits)	BC		hor. blanking pixels = 700 = 2BCh
3A	Horizontal Active and Blanking Pixels (upper nibble = upper 4 bits of active) (lower nibble = upper 4 bits of blanking)	52		
3B	Vertical Active Lines, lower 8 bits	D0		vert. active lines = 720 = 2D0h
3C	Vertical Blanking Lines, lower 8 bits	1E		vert. blanking lines = 30 = 1Eh
3D	Vertical Active: Vertical Blanking (upper nibble = upper 4 bits of active) (lower nibble = upper 4 bits of blanking)	20		
3E	Horizontal sync. offset (pixels) (from blanking starts, lower 8 bits)	B8		offset = 440 pixels = 1B8h
3F	Horizontal sync pulse width (pixels) (lower 8 bits)	28		width = 40 pixels = 28h
40	Vert sync offset; Vert sync pulse width (upper nibble = lines, lower 4 bits of vertical sync offset) (lower nibble = lines, lower 4 bits of vertical sync pulse width)	55		vert sync. offset = 5 lines vert. sync width = 5 lines
41	bits 7,6: upper 2 bits of Hor. sync. offset bits 5,4: upper 2 bits of Hor. sync pulse width bits 3,2: upper 2 bits of vert sync offset bits 1,0: upper 2 bits of vert. sync pulse width	40	01000000	
42	Horizontal Image Size (mm, lower 8 bits)	C4		Hor. Image size = 708mm = 2C4h
43	Vertical Image Size (mm, lower 8 bits)	8E		Vert. Image Size = 398mm = 18Eh
44	Horizontal and Vertical Image Size (upper nibble = upper 4 bits of horiz.) (lower nibble = upper 4 bits of vert.)	21		
45	Horizontal Border (pixels)	0		Must be 0
46	Vertical Border (pixels)	0		Must be 0
47	Flags (bit 7 = non-interlaced; bit 5,6 = normal display; bit 1, 2, 3,4 = sync description; bit 0 = don't care)	1E	00011110	Flag = non- interlaced; non-stereo; digital separate; positive V sync; positive H sync

Table 45. Example EDID Detailed Timing Descriptor for 1920X1080i (50 Hz, 16:9)

Byte# (HEX)	Function	Value (HEX)	Value (binary)	Notes
36	Pixel Clock/10,000 (LSB stored first)	01		Pixel Clock = 74.25MHz
37		1D		
38	Horizontal Active Pixels (lower 8 bits)	80		hor. active pixels = 1920 = 780h
39	Horizontal Blanking Pixels (lower 8 bits)	D0		hor. blanking pixels = 720 = 2D0h
3A	Horizontal Active and Blanking Pixels (upper nibble = upper 4 bits of active) (lower nibble = upper 4 bits of blanking)	72		
3B	Vertical Active Lines, lower 8 bits	1C		vert. active lines = 540 = 21Ch
3C	Vertical Blanking Lines, lower 8 bits	16		vert. blanking lines = 22 = 16h
3D	Vertical Active: Vertical Blanking (upper nibble = upper 4 bits of active) (lower nibble = upper 4 bits of blanking)	20		
3E	Horizontal sync. offset (pixels) (from blanking starts, lower 8 bits)	10		offset = 528 pixels = 210h
3F	Horizontal sync pulse width (pixels) (lower 8 bits)	2C		width = 44 pixels = 2Ch
40	Vert sync offset; Vert sync pulse width (upper nibble = lines, lower 4 bits of vertical sync offset) (lower nibble = lines, lower 4 bits of vertical sync pulse width)	25		vert sync. offset = 2 lines vert. sync width = 5 lines
41	bits 7,6: upper 2 bits of Hor. sync. offset bits 5,4: upper 2 bits of Hor. sync pulse width bits 3,2: upper 2 bits of vert sync offset bits 1,0: upper 2 bits of vert. sync pulse width	80	10000000	
42	Horizontal Image Size (mm, lower 8 bits)	C4		Hor. Image size = 708mm = 2C4h
43	Vertical Image Size (mm, lower 8 bits)	8E		Vert. Image Size = 398mm = 18Eh
44	Horizontal and Vertical Image Size (upper nibble = upper 4 bits of horiz.) (lower nibble = upper 4 bits of vert.)	21		
45	Horizontal Border (pixels)	0		Must be 0
46	Vertical Border (pixels)	0		Must be 0
47	Flags (bit 7 = interlaced; bit 5,6 = normal display; bit 1, 2, 3,4 = sync description; bit 0 = don't care)	9E	10011110	Flag = interlaced; non-stereo; digital separate; positive V sync; positive H sync

Table 46. Example EDID Detailed Timing Descriptor for 720x576p (50 Hz, 4:3)

Byte# (HEX)	Function	Value (HEX)	Value (binary)	Notes
36	Pixel Clock/10,000 (LSB stored first)	8C		Pixel Clock = 27.00MHz
37		0A		
38	Horizontal Active Pixels (lower 8 bits)	D0		hor. active pixels = 720 = 2D0h
39	Horizontal Blanking Pixels (lower 8 bits)	90		hor. blanking pixels = 144 = 90h
3A	Horizontal Active and Blanking Pixels (upper nibble = upper 4 bits of active) (lower nibble = upper 4 bits of blanking)	20		
3B	Vertical Active Lines, lower 8 bits	40		vert. active lines = 576 = 240h
3C	Vertical Blanking Lines, lower 8 bits	31		vert. blanking lines = 49 = 31h
3D	Vertical Active: Vertical Blanking (upper nibble = upper 4 bits of active) (lower nibble = upper 4 bits of blanking)	20		
3E	Horizontal sync. offset (pixels) (from blanking starts, lower 8 bits)	0C		offset = 12 pixels = 0Ch
3F	Horizontal sync pulse width (pixels) (lower 8 bits)	40		width = 64 pixels = 40h
40	Vert sync offset; Vert sync pulse width (upper nibble = lines, lower 4 bits of vertical sync offset) (lower nibble = lines, lower 4 bits of vertical sync pulse width)	55		vert sync. offset = 5 lines vert. sync width = 5 lines
41	bits 7,6: upper 2 bits of Hor. sync. offset bits 5,4: upper 2 bits of Hor. sync pulse width bits 3,2: upper 2 bits of vert sync offset bits 1,0: upper 2 bits of vert. sync pulse width	00	00000000	
42	Horizontal Image Size (mm, lower 8 bits)	13		Hor. Image size = 531mm = 213h
43	Vertical Image Size (mm, lower 8 bits)	8E		Vert. Image Size = 398mm = 18Eh (4:3 in this case).
44	Horizontal and Vertical Image Size (upper nibble = upper 4 bits of horiz.) (lower nibble = upper 4 bits of vert.)	21		
45	Horizontal Border (pixels)	0		Must be 0
46	Vertical Border (pixels)	0		Must be 0
47	Flags (bit 7 = non-interlaced; bit 5,6 = normal display; bit 1, 2, 3,4 = sync description; bit 0 = don't care)	18	00011000	Flag = non-interlaced; non-stereo; digital separate; negative V sync; negative H sync

Table 47. Example EDID Detailed Timing Descriptor for 720x576p (50 Hz, 16:9)

Byte# (HEX)	Function	Value (HEX)	Value (binary)	Notes
36	Pixel Clock/10,000 (LSB stored first)	8C		Pixel Clock = 27.00MHz
37		0A		
38	Horizontal Active Pixels (lower 8 bits)	D0		hor. active pixels = 720 = 2D0h
39	Horizontal Blanking Pixels (lower 8 bits)	90		hor. blanking pixels = 144 = 90h
3A	Horizontal Active and Blanking Pixels (upper nibble = upper 4 bits of active) (lower nibble = upper 4 bits of blanking)	20		
3B	Vertical Active Lines, lower 8 bits	40		vert. active lines = 576 = 240h
3C	Vertical Blanking Lines, lower 8 bits	31		vert. blanking lines = 49 = 31h
3D	Vertical Active: Vertical Blanking (upper nibble = upper 4 bits of active) (lower nibble = upper 4 bits of blanking)	20		
3E	Horizontal sync. offset (pixels) (from blanking starts, lower 8 bits)	0C		offset = 12 pixels = 0Ch
3F	Horizontal sync pulse width (pixels) (lower 8 bits)	40		width = 64 pixels = 40h
40	Vert sync offset; Vert sync pulse width (upper nibble = lines, lower 4 bits of vertical sync offset) (lower nibble = lines, lower 4 bits of vertical sync pulse width)	55		vert sync. offset = 5 lines vert. sync width = 5 lines
41	bits 7,6: upper 2 bits of Hor. sync. offset bits 5,4: upper 2 bits of Hor. sync pulse width bits 3,2: upper 2 bits of vert sync offset bits 1,0: upper 2 bits of vert. sync pulse width	00	00000000	
42	Horizontal Image Size (mm, lower 8 bits)	C4		Hor. Image size = 708mm = 2C4h
43	Vertical Image Size (mm, lower 8 bits)	8E		Vert. Image Size = 398mm = 18Eh (16:9 in this case).
44	Horizontal and Vertical Image Size (upper nibble = upper 4 bits of horiz.) (lower nibble = upper 4 bits of vert.)	21		
45	Horizontal Border (pixels)	0		Must be 0
46	Vertical Border (pixels)	0		Must be 0
47	Flags (bit 7 = non-interlaced; bit 5,6 = normal display; bit 1, 2, 3,4 = sync description; bit 0 = don't care)	18	00011000	Flag = non-interlaced; non-stereo; digital separate; negative V sync; negative H sync

Table 48. Example EDID Detailed Timing Descriptor for 720x576i (50 Hz, 4:3)

Byte# (HEX)	Function	Value (HEX)	Value (binary)	Notes
36	Pixel Clock/10,000 (LSB stored first)	8C		Pixel Clock = 27.00MHz
37		0A		
38	Horizontal Active Pixels (lower 8 bits)	A0		hor. active pixels = 1440 = 5A0h
39	Horizontal Blanking Pixels (lower 8 bits)	20		hor. blanking pixels = 288 = 120h
3A	Horizontal Active and Blanking Pixels (upper nibble = upper 4 bits of active) (lower nibble = upper 4 bits of blanking)	51		
3B	Vertical Active Lines, lower 8 bits	20		vert. active lines = 288 = 120h
3C	Vertical Blanking Lines, lower 8 bits	18		vert. blanking lines = 24 = 18h
3D	Vertical Active: Vertical Blanking (upper nibble = upper 4 bits of active) (lower nibble = upper 4 bits of blanking)	10		
3E	Horizontal sync. offset (pixels) (from blanking starts, lower 8 bits)	18		offset = 24 pixels = 18h
3F	Horizontal sync pulse width (pixels) (lower 8 bits)	7E		width = 126 pixels = 7Ch
40	Vert sync offset; Vert sync pulse width (upper nibble = lines, lower 4 bits of vertical sync offset) (lower nibble = lines, lower 4 bits of vertical sync pulse width)	23		vert sync. offset = 2 lines vert. sync width = 3 lines
41	bits 7,6: upper 2 bits of Hor. sync. offset bits 5,4: upper 2 bits of Hor. sync pulse width bits 3,2: upper 2 bits of vert sync offset bits 1,0: upper 2 bits of vert. sync pulse width	00	00000000	
42	Horizontal Image Size (mm, lower 8 bits)	13		Hor. Image size = 531mm = 213h
43	Vertical Image Size (mm, lower 8 bits)	8E		Vert. Image Size = 398mm = 18Eh (4:3 in this case).
44	Horizontal and Vertical Image Size (upper nibble = upper 4 bits of horiz.) (lower nibble = upper 4 bits of vert.)	21		
45	Horizontal Border (pixels)	0		Must be 0
46	Vertical Border (pixels)	0		Must be 0
47	Flags (bit 7 = non-interlaced; bit 5,6 = normal display; bit 1, 2, 3,4 = sync description; bit 0 = don't care)	98	10011000	Flag = interlaced; non-stereo; digital separate; negative V sync; negative H sync

Table 49. Example EDID Detailed Timing Descriptor for 720x576i (50 Hz, 16:9)

Byte# (HEX)	Function	Value (HEX)	Value (binary)	Notes
36	Pixel Clock/10,000 (LSB stored first)	8C		Pixel Clock = 27.00MHz
37		0A		
38	Horizontal Active Pixels (lower 8 bits)	A0		hor. active pixels = 1440 = 5A0h
39	Horizontal Blanking Pixels (lower 8 bits)	20		hor. blanking pixels = 288 = 120h
3A	Horizontal Active and Blanking Pixels (upper nibble = upper 4 bits of active) (lower nibble = upper 4 bits of blanking)	51		
3B	Vertical Active Lines, lower 8 bits	20		vert. active lines = 288 = 120h
3C	Vertical Blanking Lines, lower 8 bits	18		vert. blanking lines = 24 = 18h
3D	Vertical Active: Vertical Blanking (upper nibble = upper 4 bits of active) (lower nibble = upper 4 bits of blanking)	10		
3E	Horizontal sync. offset (pixels) (from blanking starts, lower 8 bits)	18		offset = 24 pixels = 18h
3F	Horizontal sync pulse width (pixels) (lower 8 bits)	7E		width = 126 pixels = 7Eh
40	Vert sync offset; Vert sync pulse width (upper nibble = lines, lower 4 bits of vertical sync offset) (lower nibble = lines, lower 4 bits of vertical sync pulse width)	23		vert sync. offset = 2 lines vert. sync width = 3 lines
41	bits 7,6: upper 2 bits of Hor. sync. offset bits 5,4: upper 2 bits of Hor. sync pulse width bits 3,2: upper 2 bits of vert sync offset bits 1,0: upper 2 bits of vert. sync pulse width	00	00000000	
42	Horizontal Image Size (mm, lower 8 bits)	C4		Hor. Image size = 708mm = 2C4h
43	Vertical Image Size (mm, lower 8 bits)	8E		Vert. Image Size = 398mm = 18Eh (16:9 in this case).
44	Horizontal and Vertical Image Size (upper nibble = upper 4 bits of horiz.) (lower nibble = upper 4 bits of vert.)	21		
45	Horizontal Border (pixels)	0		Must be 0
46	Vertical Border (pixels)	0		Must be 0
47	Flags (bit 7 = non-interlaced; bit 5,6 = normal display; bit 1, 2, 3,4 = sync description; bit 0 = don't care)	98	10011000	Flag = interlaced; non-stereo; digital separate; negative V sync; negative H sync

ANNEX B: APPLICATION TO DVI 1.0 (Normative)

All mandatory aspects of DVI 1.0 [2] shall be implemented with the exception of those expressly identified as optional or informative in that standard when DVI 1.0 is used to implement this standard (861B). It should be noted that this version of DVI does not support transport of CEA InfoPackets. New interfaces that support the transmission of InfoPackets and are backward compatible with DVI 1.0 are expected to be available soon¹. However, CEA/EIA-861B can still be implemented on DVI 1.0 (with reduced functionality) as explained in Section 6.

All sections in this Annex are normative when DVI 1.0 is used to implement this standard except as otherwise noted.

B.1 DVI Synchronization (informative)

The synchronizing signals are carried like other control words, using 7-transition words (as opposed to the 5-transition words used for video data). The Hsync and Vsync are sent as C1 and C0 with the blue channel, and are sent when the data enable signal (DE) is low. The following table shows the 10-bit code words used for each of the four possible states of the Hsync-Vsync signal pair.

Table 50. Synchronizing signal data for DVI

State	C1	C0	10-bit Code word
Both low	0	0	0010101011
Vsync high	0	1	1101010100
Hsync high	1	0	0010101010
Both High	1	1	1101010101

B.2 Connector and Cable

The connector used shall be DVI-Digital, Single Link [2].

The cable supplied with the product shall be capable of reliably carrying the signal with the maximum pixel clock frequency compatible with the product.

B.3 Digital Content Protection

High -bandwidth Digital Content Protection (HDCP) [4] shall be available to authenticate display devices and encrypt content transmitted across the DVI interface.

B.4 Additional Information

EIA/CEA-861-B

DVI 1.0: www.ddwg.org

HDCP: www.digital-cp.com

ANNEX C: APPLICATION TO Open LDI (Normative)

All mandatory aspects of OpenLDI 0.95 [7] shall be implemented with the exception of those expressly identified as optional or informative in that standard when OpenLDI 0.95 is used to implement this standard (861B). It should be noted that at the time of this writing, a version of OpenLDI that supports transport of CEA InfoPackets was not available. However, CEA/EIA-861B can still be implemented on OpenLDI 0.95 (with reduced functionality) as explained in Section 6.

All sections in this Annex are normative when OpenLDI 0.95 is used to implement this standard except as otherwise noted.

C.1 Open LDI Data and Control Signals

OpenLDI has two options for display synchronization:

1. DC Balance Mode:
2. Non DC Balance Mode:

In DC Balance mode synchronization is accomplished by transmitting control signals during the Display blanking intervals as shown in Figure 25.

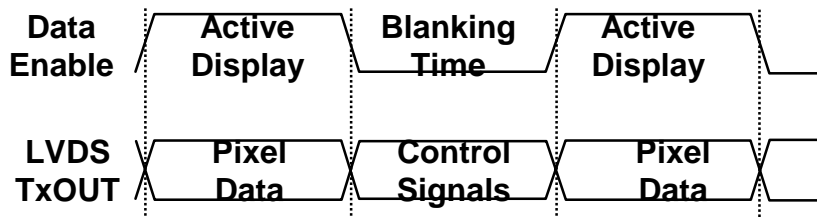

Figure 25. OpenLDI Synchronization

In the single or dual LVDS bus mode (24 or 48 bit Total) the control signals are transmitted over 7 transition words on specific output signals during the blanking period as indicated in Table 51.

Table 51. OpenLDI Control Signals

Control Signal	Signal Level	Output Signal	Data Pattern
DE	High	CLK1 and CLK2	1111000 or 1110000
	Low		1111100 or 1100000
HSYNC	High	A0	1100000 or 1111100
	Low		1110000 or 1111000
VSYNC	High	A1	1100000 or 1111100
	Low		1110000 or 1111000

C.2 Non DC Balanced Mode:

Control signals are transmitted as part the LVDS serialized data stream. The controls signals are then de-serialized and regenerated at the receiver outputs to the EDTV/HDTV Monitor.

C.3 OpenLDI Cabling Information:

An OpenLDI cable assembly shall consist of a cable meeting the requirements of this section with an OpenLDI plug on each end or an OpenLDI plug on one end and the other end permanently affixed to the display device. Acceptable cables for OpenLDI may use either shielded or unshielded twisted pairs. It is up to the manufacturer of the OpenLDI equipment to use the grade and type of cable required to meet applicable regulatory requirements. Adherence to this standard does not guarantee regulatory compliance.

When the OpenLDI is an interface internal to an assembly and not accessible externally, the OpenLDI cable may be replaced with any cable or connection means appropriate to the requirements of the assembly.

C.3.1 Cable Length

The maximum cable length shall be 10m.

C.3.2 Number of Signal Conductors

The OpenLDI cable shall comprise 11 twisted pairs and 10 individual conductors.

C.3.3 Wire Gauge

Each conductor in an OpenLDI cable shall be no less than 28AWG.

C.3.4 Conductor Resistance

The resistance of a single conductor of an OpenLDI cable shall not exceed 4Ω when the conductor is of the maximum length specified in this standard.

C.3.5 Insulation

Each conductor in the cable shall be separately insulated. The minimum insulation resistance shall be $1G\Omega$.

C.3.6 Shield Requirement

The OpenLDI cable shall be encompassed by a single shield, surrounding all conductors in the cable. The shield shall provide a minimum of 90% coverage.

For shielded twisted pair cable, each twisted pair shall be shielded individually. Each shield shall provide a minimum of 90% coverage.

C.3.7 Single Twisted Pair Transmission Skew

The differential time of transmission (single pair transmission skew) of a pulse through a single differential pair in an OpenLDI cable shall not exceed 300ps.

C.3.8 Multiple Twisted Pair Transmission Skew

The differential time of transmission (pair to pair transmission skew) of a pulse through any two differential pairs in an OpenLDI cable shall not exceed 1 bit time.

C.3.9 USB Cable Requirements

The conductors used for transmission of USB signals on the OpenLDI cable shall meet the requirements stated in the Universal Serial Bus Specification, Version 1.0, January 15, 1996.

C.3.10 DDC Cable Requirements

The conductors used for transmission of DDC signals on the OpenLDI cable shall meet the requirements stated in the VESA Display Data Channel Command Interface (DDC/CI) Standard, Version 1, August 14, 1998 [35].

More information on the connector is available in Section 7.2 of the OpenLDI specification [7].

OpenLDI .95 website Location:

WWW.National.com/appinfo/fpd

ANNEX D: Reserved for Future Use

ANNEX E: Reserved for Future Use

ANNEX F: Format Conversion Examples

(Informative)

In the example shown below in Figure 26, the DTV Monitor indicates by its EDID data that it can accept 1080i, 720p, 480i, or 480p. In the cases labeled (a), the conversion from the source material to 1080i is happening in the source box. In the other case, labeled (b), the source does no format conversion and delivers the as-decoded format across the interface. Conversion to 1080i is happening in the Display. If the Display indicates it has a single 1080i native format, it may not matter where the conversion takes place. If the Display is multi-scan and indicates the other formats are supported natively also, the best image presentation will probably result if the conversion takes place in the Display.

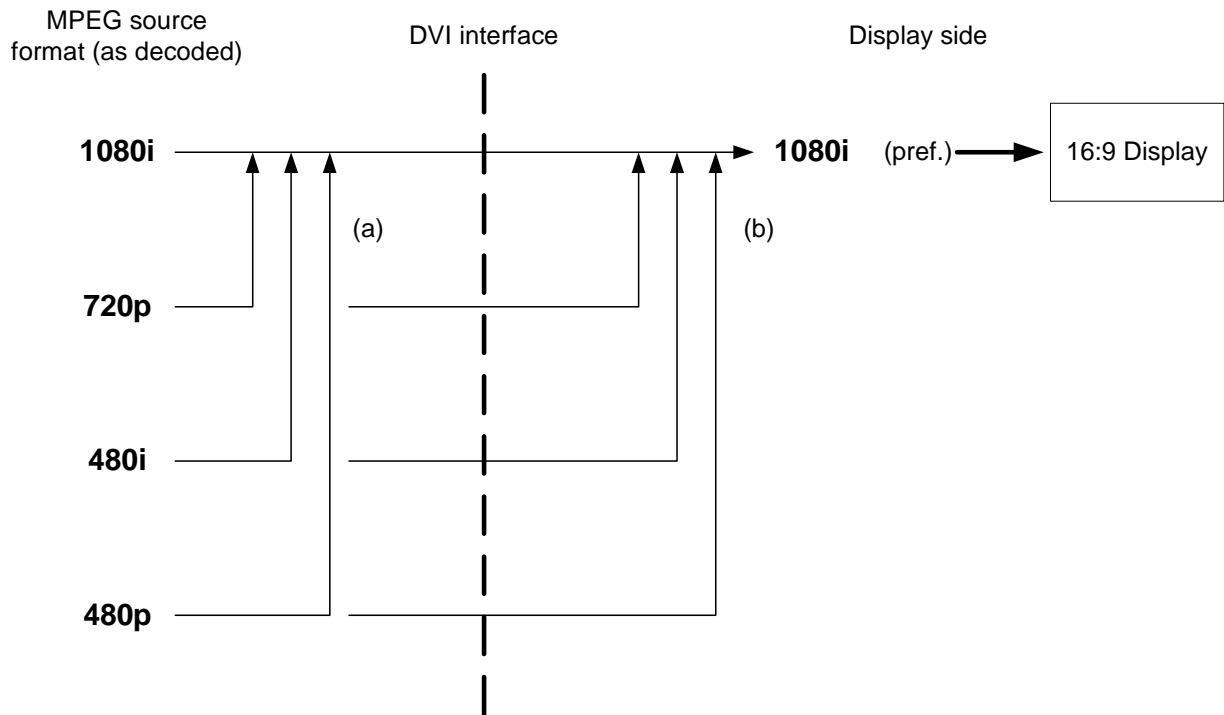

Figure 26. Example of options for format conversion

In the example in Figure 27, the DTV Monitor can once again support 1080i, 720p, 480i, or 480p. In this case, the display is a 1024 by 576 LCD panel so none of these formats is native (although 720p is indicated as being “preferred”). The illustration shows conversions either taking place in the source device, in the Display, or in both. Any conversion performed in the source box is to 720p because 720p is indicated as the preferred format. This is a situation where at least one conversion must take place. In general, format conversions introduce errors and display artifacts. In the optimum system, at most one format conversion should be done between the MPEG-2 decoder and visual presentation.

In Figure 27, MPEG-2 video in 1080i format is decoded, and can be converted (c) into the display’s preferred 720p format. In this case, the Display re-converts 720p into its native 1024 x 576 LCD format. Alternatively, the 1080i video can be delivered unconverted across the interface (d) where the Display performs one conversion to its native format. The cases marked (e) are similar, in that two conversions result if the source re-formats into 720p before delivering the data across the interface, but just one conversion results if the video is delivered in the same format as it was decoded. These cases illustrate that the best visual presentation may result when the source device transports the video to the Display in the same basic format as the decoded MPEG2 stream (assuming the ultimate source is MPEG2).

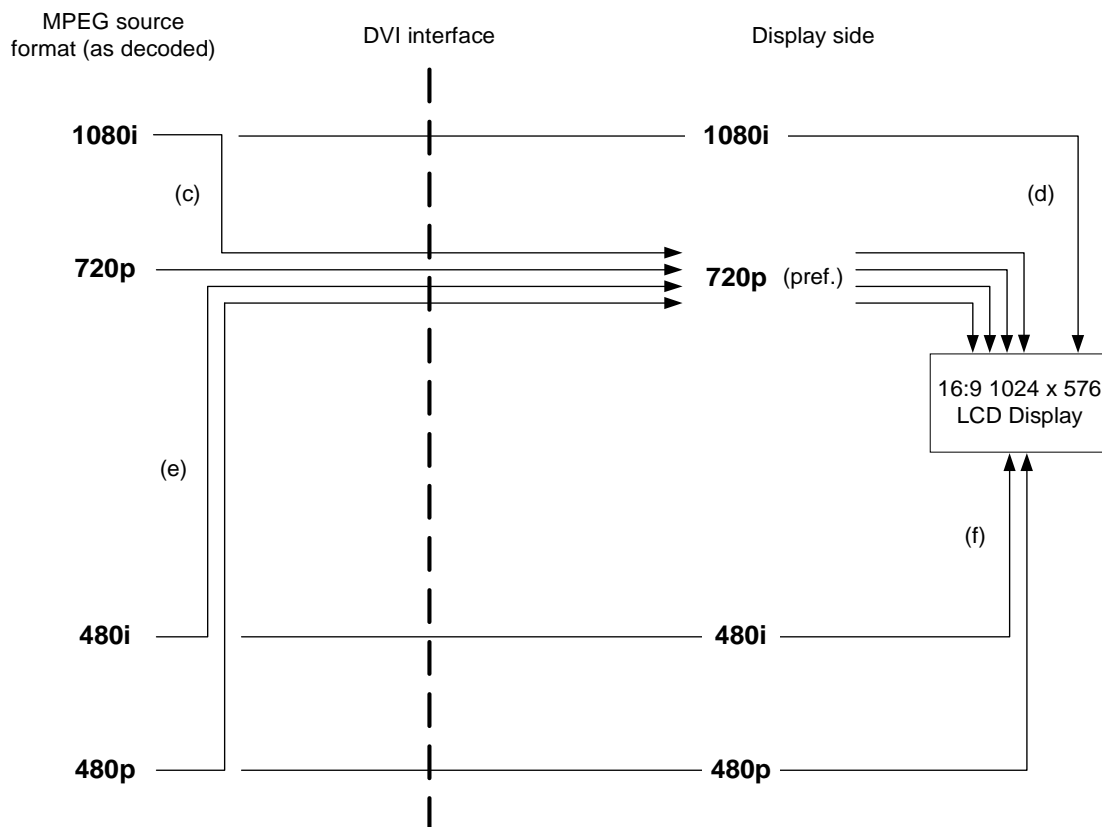

Figure 27. Multiple conversions example

ANNEX G: InfoPacket Framework

(Normative)

G.1 General Format of InfoPackets and InfoFrames

The general format of the InfoPacket is shown in Table 52. An InfoPacket can carry more than one InfoFrame. One InfoPacket can be sent every video frame. In order to accommodate the addition of future “InfoFrames,” the data envelope provided by the interface (e.g., DVI or OpenLDI) shall be capable of transporting a total of 255 bytes every video frame. To allow for hardware parsing, each InfoFrame shall be limited to 28 bytes. A means for discovering how many InfoFrames are supported by the sink device (i.e., DTV Monitor) is interface implementation specific and can be provided through the use of the Vendor Specific Data Block in the CEA EDID Timing Extension.

The InfoPacket structure is a middle layer of a communication protocol. The information can be transported from the source to destination over several different physical/link layers. It is anticipated that the InfoPacket will be supplied to the lower layers in the source device via a serial link, set of registers, or something similar and that it will be transferred to the upper layers from the physical/link layer on the receiving end exactly as it was constructed on the source end. The physical/link layers may segment the InfoPacket at the source and reassemble it on the receiving end.

Table 52. General Format of InfoPacket

Byte#	Field Name	Contents	
1	Start Code	10101010	
2	Total Length	L_T - Total number of bytes in InfoPacket following this byte.	
InfoFrame 1	3	InfoFrame 1 Type	Info Frame 1 Type Code (See Table 53)
	4	InfoFrame 1 Version	InfoFrame 1 Version Number
	5	InfoFrame 1 Length	L_1 - Total number of bytes in InfoFrame 1 Payload.
	6 ... $3+L_1-1$	InfoFrame 1 Payload	Dependent on type of InfoFrame. For AVI payload, see Section 6.
InfoFrame 2	$3+L_1$	InfoFrame 2 Type	Info Frame 2 Type Code (See Table 53)
		InfoFrame 2 Version	InfoFrame 2 Version Number
	$3+L_1+1$	InfoFrame 2 Length	L_2 - Total number of bytes in InfoFrame 2 Payload.
	$3+L_1+2$... $3+L_1+L_2-1$	InfoFrame 2 Payload	
...	
InfoFrame N	L_T-L_N	InfoFrame N Type	InfoFrame N Type Code (See Table 53)
		InfoFrame N Version	InfoFrame N Version Number
	L_T-L_N+1	InfoFrame N Length	L_N - Total number of bytes in InfoFrame N Payload.
	L_T-L_N+2 ... L_T-1	InfoFrame N Payload	
	L_T	Checksum	Chosen such that the sum of all of the bytes including this checksum equals 00h.

If the checksum of the InfoPacket received at the DTV Monitor is incorrect, it is recommended that the DTV Monitor discard that InfoPacket.

The length field of the InfoPacket shall be set to the number of bytes following the length field including the checksum.

G.2 Types of InfoFrames

The InfoPacket is an extensible packet structure designed to carry various types of InfoFrames from a video source to a video destination across an uncompressed digital video interface such as DVI, OpenLDI, or similar physical interface. This general packet structure is required so that new or modified InfoFrames can be added in the future without breaking backward compatibility to this standard and subsequent versions of this standard. Five types of InfoFrames are defined in this standard (Auxiliary Video Information InfoFrame, Vendor Specific InfoFrame, Source Product Description InfoFrame, Audio InfoFrame, and MPEG Source InfoFrame). The assigned

type codes for these InfoFrames are shown in Table 53. Note that the first byte of the InfoFrame designates the type of InfoFrame while the second byte indicates the version of that particular InfoFrame. All future versions of a specific InfoFrame shall be backward compatible with previous versions. They may contain additional information, but old and new devices should be able to access and interpret the information previously present. All of the InfoFrames defined in this standard are version 1 except for the AVI InfoFrame which has a version 1 and version 2. The InfoFrame Length Field is contained in the third byte of each InfoFrame. This length field is the total number of bytes in the InfoFrame Payload. It does not include the Type, Version, or Length fields. In the case of the Vendor Specific InfoFrame, the length includes the 24-bit IEEE Registration ID (see Table 54).

When creating new versions of an InfoFrame, the version number shall be incremented from what it was in the previous version. New versions of any specific InfoFrame shall contain all of the fields in the previous version for the purpose of backward compatibility. The length field shall always be set correctly so that DTV Monitors that don't fully understand the format of a given InfoFrame may skip to the end.

Table 53. List of InfoFrame Type Codes

Info Frame Type Code	Type of InfoFrame
00 ₁₆	Reserved
01 ₁₆	Vendor Specific (defined in this Annex)
02 ₁₆	Auxiliary Video Information (defined in Section 6.1 of this document)
03 ₁₆	Source Product Description (defined in Section 6.2 of this document)
04 ₁₆	Audio (defined in Section 6.3 of this document)
05 ₁₆	MPEG Source (defined in Section 6.4 of this document)
06 ₁₆ -FF ₁₆	Reserved for future

The contents of the Auxiliary Video Information InfoFrame is described in Section 6.1. The contents of the Product Description InfoFrame is described in Section 6.2. The contents of the Audio InfoFrame is described in Section 6.3. The contents of the MPEG Source InfoFrame is described in Section 6.4.

The content of the Vendor Specific InfoFrame is defined in Table 54 below. This InfoFrame can be used by product manufacturers or organizations who have an assigned 24-bit IEEE Registration Identifier to transport information not defined elsewhere. The Vendor Specific Payload would be defined by the organization to which the 24-bit IEEE number refers. The 24-bit IEEE number is sent lower byte first. It is recommended that the Vendor Specific Payload contain a "length field" to facilitate extensibility, but this is not required.

Table 54. Vendor Specific InfoFrame

Byte #	Field Name	Contents
n	Vendor Specific InfoFrame Type Code	01 ₁₆
n+1	Vendor Specific InfoFrame Version	01 ₁₆
n+2	L _V InfoFrame Length	Total number of bytes in InfoFrame Payload including IEEE Registration ID
n+3	24 bit IEEE Registration Identifier	24 bit IEEE Registration ID ²³ (Least Significant Byte first)
....		
n+5		
...	Vendor Specific Payload	Vendor Specific Payload
n+L _V -1		

G.3 Example AVI InfoFrame in InfoPacket

An example of an InfoPacket containing one AVI InfoFrame is shown in Table 55 below.

²³ The IEEE Registration Authority maintains a database of 24-bit numbers uniquely assigned to organizations and vendors. Any organization or vendor that wishes to define a vendor specific InfoFrame shall obtain a registration ID (also known as vendor ID, organizationally unique ID, or company ID) from:
 Institute of Electrical and Electronic Engineers, Inc.
 IEEE Registration Authority
 c/o IEEE Standards Association
 445 Hoes Lane
 Piscataway, NJ 08855-1331

Table 55. Example Version 1 AVI InfoFrame in InfoPacket (Informative)

Start Code	1	0	1	0	1	0	1	0
Info Packet Length following this byte	0	0	0	1	0	0	0	1
AVI Info Frame Type Code	0	0	0	0	0	0	1	0
AVI InfoFrame Version Number	0	0	0	0	0	0	0	1
AVI Info Frame Payload Length	0	0	0	0	1	1	0	1
Data Byte 1	0	0	0	1	1	1	0	0
Data Byte 2	0	0	0	1	1	0	1	0
Data Byte 3	0	0	0	0	0	0	0	0
Data Byte 4	0	0	0	0	0	0	0	0
Data Byte 5	0	0	0	0	0	0	0	0
Data Byte 6 (End of Top Bar - upper byte)	0	0	0	0	0	0	0	0
Data Byte 7 (End of Top Bar - lower byte)	0	0	1	1	1	1	0	0
Data Byte 8 (Beginning of Bottom Bar - upper byte)	0	0	0	0	0	0	0	1
Data Byte 9 (Beginning of Bottom Bar - lower byte)	1	0	1	0	0	1	0	1
Data Byte 10 (End of Left Bar - upper byte)	0	0	0	0	0	0	0	0
Data Byte 11 (End of Left Bar - lower byte)	0	0	0	0	0	0	0	0
Data Byte 12 (Beginning of Right Bar - upper byte)	0	0	0	0	0	0	1	0
Data Byte 13 (Beginning of Right Bar - lower byte)	1	1	0	1	0	0	0	1
Checksum	0	1	0	0	1	0	1	0

In this example:

- Y0=0 and Y1=0 indicating data is in RGB format (default)
- A0=1 indicating that active format information is present
- B0=1 indicating that Vertical Bar information is valid.
- B1=1 indicating that Horizontal Bar information is valid
- S1 and S0 = 0 indicating no information regarding underscan/overscan
- C1 and C0 = 0 indicating no information on colorimetry

- $M1|M0 = 01$ indicating a 4:3 picture (the DTV Monitor knows it is receiving 720X480 format from the video itself).
- $R3|R2|R1|R0 = 1010$ indicating an active format of 16:9
- $SC1$ and $SC0 = 0$ indicating no known non-uniform scaling.
- Line Number of End of Top Horizontal Bar = $60 = 3C_{16}$
- Line Number of Start of Bottom Horizontal Bar = $421 = 1A5_{16}$
- Pixel Number of End of Left Vertical Bar = 0
- Pixel Number of Start of Right Vertical Bar = $721 = 2D1_{16}$

ANNEX H: DVB Active Format Description (Informative)

This Annex is extracted from Annex B of the DVB Guidelines document [3]. Figure 28 illustrates the meanings of the bounding rectangles, gray areas, and white circles as used in Table 56.

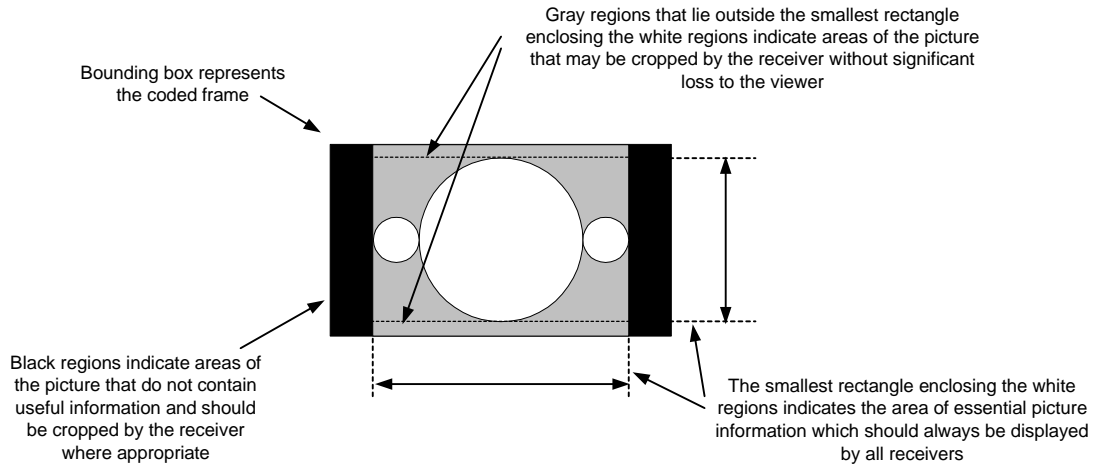
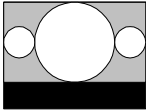
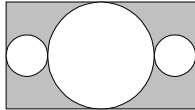
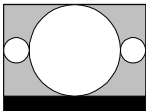
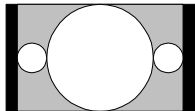
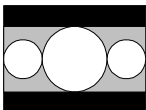
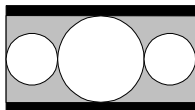
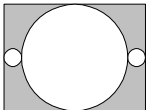
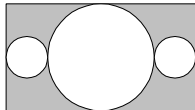
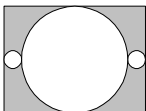
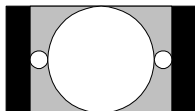
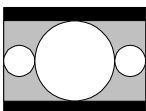
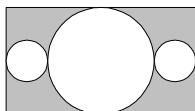
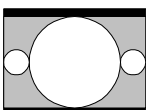
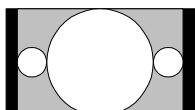
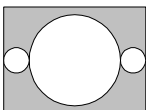
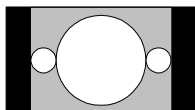
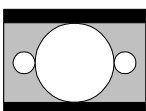
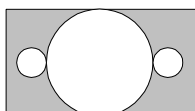
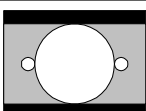
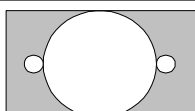

Figure 28. Active Format Illustration

Definitions:

Coded Frame	A picture within a compressed video stream such as MPEG2 that is coded as a single frame or as two fields.
Coded Frame Aspect Ratio	The picture aspect ratio associated with the coded frame of a compressed video stream such as MPEG2. It is either 4:3 or 16:9.

Table 56. AFD Coding

active_format		illustration of described format	
value	description	in 4:3 coded frame	in 16:9 coded frame
0000 - 0001	reserved		
0010	box 16:9 (top)		
0011	box 14:9 (top)		
0100	box > 16:9 (center)		
0101 - 0111	reserved		
1000	As the coded frame		
1001	4:3 (center)		 ¹⁸
1010	16:9 (center)		
1011	14:9 (center)		
1100	reserved		
1101	4:3 (with shoot & protect 14:9 center)		 ¹⁸
1110	16:9 (with shoot & protect 14:9 center)		
1111	16:9 (with shoot & protect 4:3 center)		

¹⁸ It is recommended to use the 4:3 coded frame mode to transmit 4:3 source material rather than using a pillar box to transmit it in a 16:9 coded frame. This allows for higher horizontal resolution on both 4:3 and 16:9 sets.

ANNEX I: Picture Aspect Ratio Conversion Example (Informative)

The example below illustrates a possible problem if both the source and DTV Monitor stretch the video horizontally to fit into a picture with a larger aspect ratio.

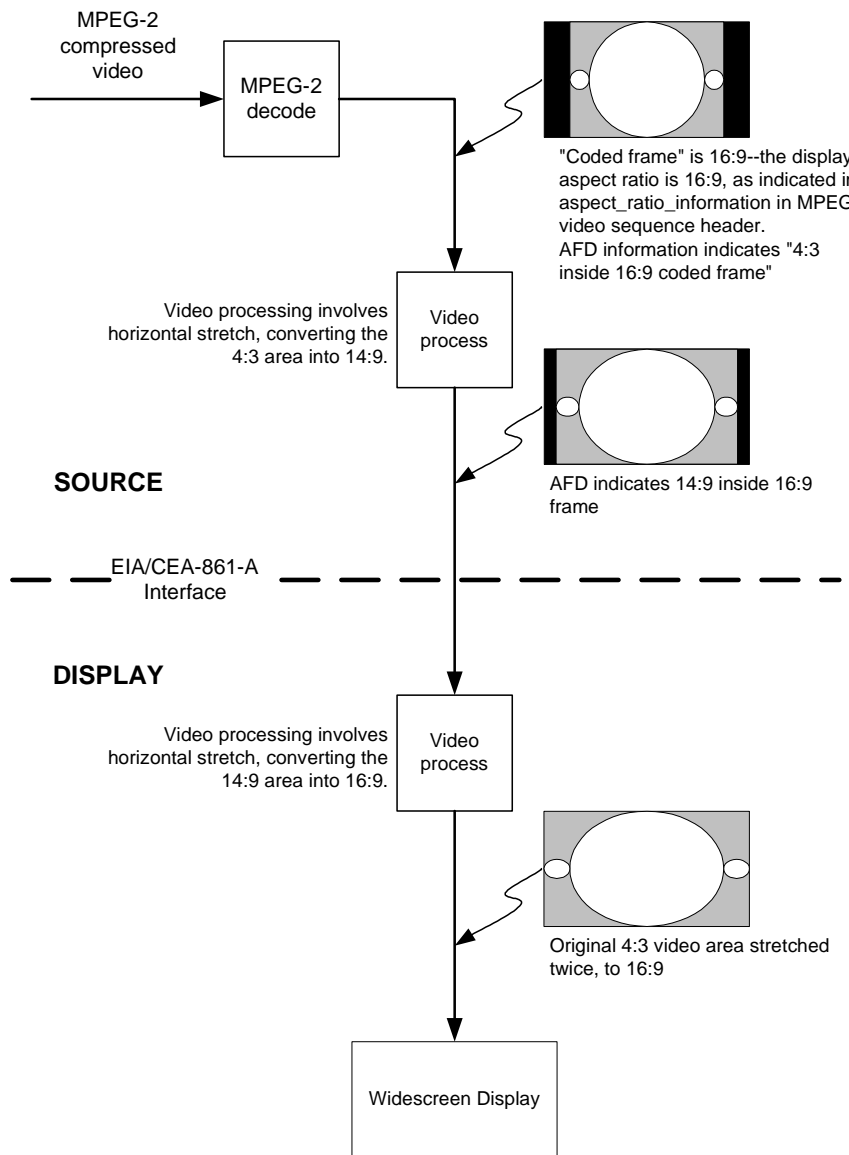

Figure 29. Example of problem resulting from double stretch

ANNEX J: Typical Audio Applications (Informative)

Table 57. Some Typical Audio Applications

Audio Type	Application	Constraints	References
LPCM	DVD-Video	Sample Rate = 48kHz or 96kHz. Sample Size = 16, 20, 24 bits Max Channels = 8	17
LPCM	DVD-Audio	Sample Rate = 44.1, 48, 88.2, 176.4, 192kHz Sample Size = 16, 20, 24 bits Max Channels = 6	18
AC-3	ATSC/SCTE	Sample Rate = 48kHz Max Bit Rate = 128, 192, 384, 448, 512kbps	21, 15
AC-3	DVD-Video	Sample Rate = 48kHz Max Bit Rate = 64, 448kbps	17
MPEG1 (layers 1 & 2)	MPEG Satellite	Sample Rate = 32, 44.1, 48kHz Max Bit Rate (layer 1) = 32, 64, 96, 128, 160, 192, 224, 256, 288, 320, 352, 384kbps Max Bit Rate (layer 2) = 32, 48, 56, 64, 80, 96, 112, 128, 160, 192, 224, 256, 320, 384kbps	21, 28
MPEG1 (layers 1 & 2)	DVD-Video	Sample Rate = 48kHz Max Bit Rate = 384kbps	17, 28
MPEG1 (layers 1 & 2)	DVB	Same as "MPEG Satellite"	24, 28
MPEG2	DVD-Video	Sample Rate = 48kHz Max Bit Rate = 528kbps, 912kbps for main plus extension.	17, 29
MPEG2	DVB	Max Bit Rate of Extension = 682kbps	24, 29
MP3 (MPEG1 - layer 3)	MP3 Players	Sample Rate = 32, 44.1, 48kHz Max Bit Rate = 32, 40, 48, 56, 64, 80, 96, 112, 128, 160, 192, 224, 256, 320kbps	28
AAC (MPEG4)	Natural Audio Profile	Sampling Rate = 48, 96kHz	30

EIA Document Improvement Proposal

If in the review or use of this document, a potential change is made evident for safety, health or technical reasons, please fill in the appropriate information below and mail or FAX to:

Electronic Industries Alliance
Technology Strategy & Standards Department – Publications Office
2500 Wilson Blvd.
Arlington, VA 22201
FAX: (703) 907-7501

Document No.	Document Title:
Submitter's Name:	Telephone No.: FAX No.: e-mail:
Address:	
Urgency of Change: Immediate: <input type="checkbox"/> At next revision: <input type="checkbox"/>	
Problem Area: a. Clause Number and/or Drawing: b. Recommended Changes: c. Reason/Rationale for Recommendation:	
Additional Remarks:	
Signature:	Date:
FOR EIA USE ONLY	
Responsible Committee:	
Chairman:	
Date comments forwarded to Committee Chairman:	

