



LCD Monitor User Manual

G2590FX LED backlight



Safety.....	4
National Conventions.....	4
Power	5
Installation.....	6
Cleaning.....	7
Other.....	8
Setup	9
Contents in Box	9
Setup Base&Stand.....	10
Adjusting Viewing Angle.....	11
Connecting the Monitor.....	12
Wall Mounting	13
Free-Sync function.....	14
Adjusting	15
Setting Optimal Resolution	15
Windows 10	15
Windows 8	17
Windows 7	19
Hotkeys.....	21
OSD Setting.....	22
Luminance	23
Image Setup	24
Color Setup.....	25
Picture Boost	26
OSD Setup	27
Game Setting.....	28
Extra	29
Exit.....	30
LED Indicator.....	30
Driver	31
Monitor Driver	31
Windows 10	31
Windows 8	35
Windows 7	39
i-Menu.....	42
e-Saver	43
Screen+	44
Troubleshoot.....	45
Specification.....	46
General Specification	46
Preset Display Modes.....	47
Pin Assignments	48
Plug and Play.....	50
WEEE Declaration	50
Regulation.....	51
FCC Notice	51

Restriction on Hazardous Substances statement (India)	52
E-Waste Declaration for India	52
Service	53
Warranty Statement for Europe.....	53
Warranty Statement for Middle East and Africa (MEA)	55
AOC PIXEL POLICY	57
ISO 9241-307 CLASS 1	57
Warranty Statement for North & South America (excluding Brazil)	58
Warranty Statement for India	60
EASE PROGRAME	63

Safety

National Conventions

The following subsections describe notational conventions used in this document.

Notes, Cautions, and Warnings

Throughout this guide, blocks of text may be accompanied by an icon and printed in bold type or in italic type. These blocks are notes, cautions, and warnings, and they are used as follows:



NOTE: A NOTE indicates important information that helps you make better use of your computer system.





CAUTION: A CAUTION indicates either potential damage to hardware or loss of data and tells you how to avoid the problem.





WARNING: A WARNING indicates the potential for bodily harm and tells you how to avoid the problem. Some warnings may appear in alternate formats and may be unaccompanied by an icon. In such cases, the specific presentation of the warning is mandated by regulatory authority.

Power

 The monitor should be operated only from the type of power source indicated on the label. If you are not sure of the type of power supplied to your home, consult your dealer or local power company.

 The monitor is equipped with a three-pronged grounded plug, a plug with a third (grounding) pin. This plug will fit only into a grounded power outlet as a safety feature. If your outlet does not accommodate the three-wire plug, have an electrician install the correct outlet, or use an adapter to ground the appliance safely. Do not defeat the safety purpose of the grounded plug.

 Unplug the unit during a lightning storm or when it will not be used for long periods of time. This will protect the monitor from damage due to power surges.

 Do not overload power strips and extension cords. Overloading can result in fire or electric shock.

 To ensure satisfactory operation, use the monitor only with UL listed computers which have appropriate configured receptacles marked between 100-240V AC, Min. 5A.

 The wall socket shall be installed near the equipment and shall be easily accessible.

Installation

! Do not place the monitor on an unstable cart, stand, tripod, bracket, or table. If the monitor falls, it can injure a person and cause serious damage to this product. Use only a cart, stand, tripod, bracket, or table recommended by the manufacturer or sold with this product. Follow the manufacturer's instructions when installing the product and use mounting accessories recommended by the manufacturer. A product and cart combination should be moved with care.

! Never push any object into the slot on the monitor cabinet. It could damage circuit parts causing a fire or electric shock. Never spill liquids on the monitor.

! Do not place the front of the product on the floor.

! If you mount the monitor on a wall or shelf, use a mounting kit approved by the manufacturer and follow the kit instructions.

! Leave some space around the monitor as shown below. Otherwise, air-circulation may be inadequate hence overheating may cause a fire or damage to the monitor.

See below the recommended ventilation areas around the monitor when the monitor is installed on the wall or on the stand:

Installed with stand

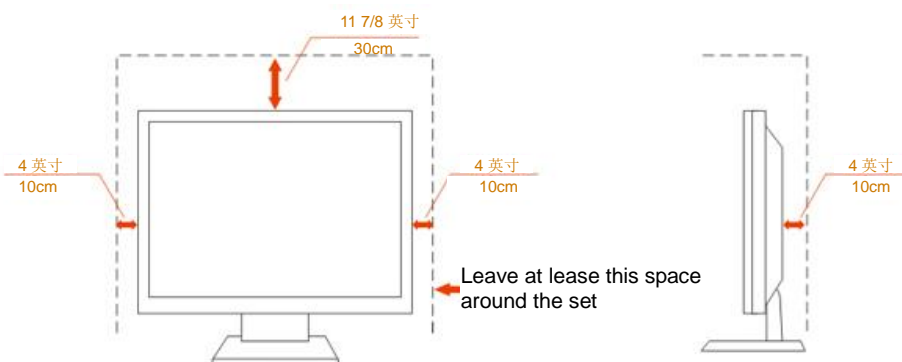

Cleaning

⚠ Clean the cabinet regularly with cloth. You can use soft-detergent to wipe out the stain, instead of strong-detergent which will cauterize the product cabinet.

⚠ When cleaning, make sure no detergent is leaked into the product. The cleaning cloth should not be too rough as it will scratch the screen surface.

⚠ Please disconnect the power cord before cleaning the product.



Other

 If the product is emitting a strange smell, sound or smoke, disconnect the power plug IMMEDIATELY and contact a Service Center.

 Make sure that the ventilating openings are not blocked by a table or curtain.

 Do not engage the LCD monitor in severe vibration or high impact conditions during operation.

 Do not knock or drop the monitor during operation or transportation.

Setup

Contents in Box



Monitor

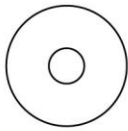

CD Manual



Warranty card



Stand

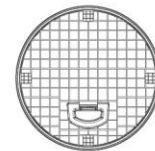

Base



Power Cable



Audio Cable



Analog Cable



DP Cable



HDMI Cable

* Not all signal cables (Audio, Analog, DP, HDMI cables) will be provided for all countries and regions. Please check with the local dealer or AOC branch office for confirmation.

Setup Base&Stand

Please setup or remove the base following the steps as below.

Please place the monitor on a soft and flat surface to prevent the scratch.

Setup:

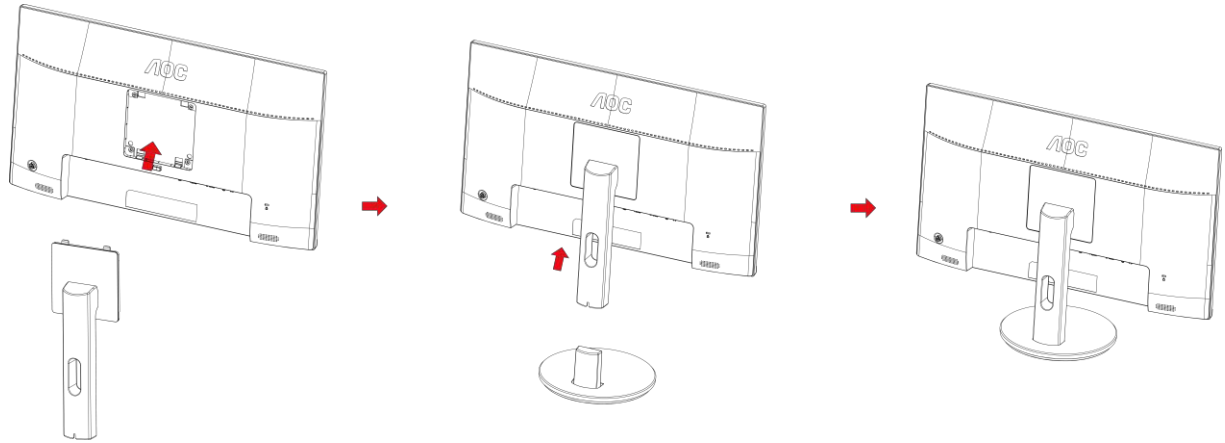

Remove:

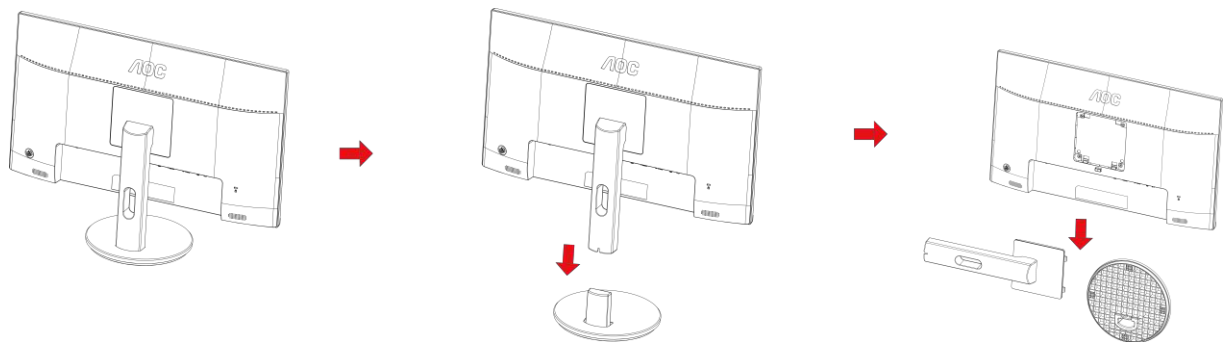

Adjusting Viewing Angle

For optimal viewing it is recommended to look at the full face of the monitor, then adjust the monitor's angle to your own preference.

Hold the stand so you will not topple the monitor when you change the monitor's angle.

You are able to adjust the monitor as below:

Tilt angle: -5° ~ 23°

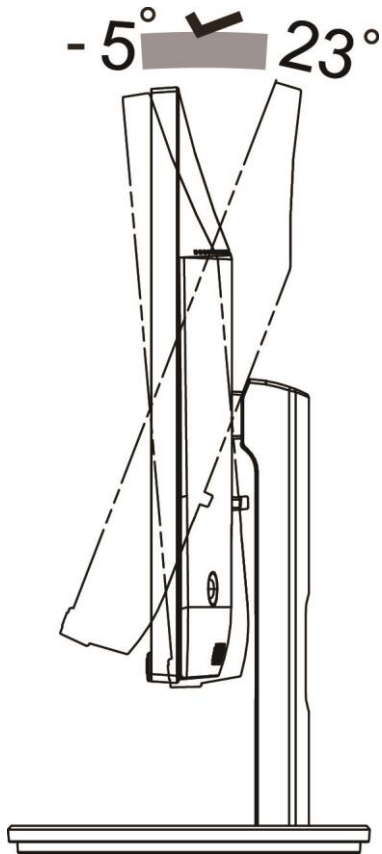

NOTE:

Do not adjust the viewing angle over 23 degrees in order to avoid damage.

Connecting the Monitor

Cable Connections In Back of Monitor and Computer:

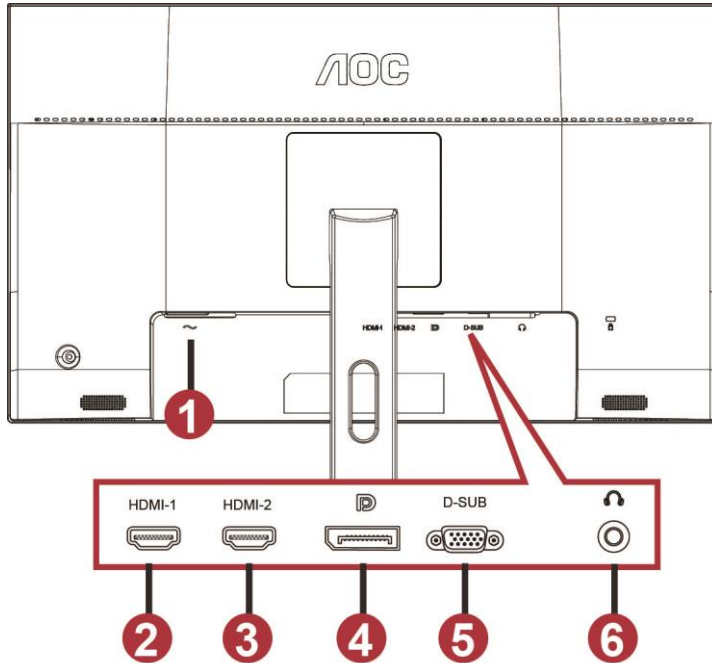

- 1 Power
- 2 HDMI-1
- 3 HDMI-2
- 4 DP
- 5 VGA
- 6 Earphone

To protect equipment, always turn off the PC and LCD monitor before connecting.

- 1 Connect the power cable to the AC port on the back of the monitor.
- 2 Connect one end of the 15-pin D-Sub cable to the back of the monitor and connect the other end to the computer's D-Sub port.
- 3 (Optional – Requires a video card with HDMI port) - Connect one end of the HDMI cable to the back of the monitor and connect the other end to the computer's HDMI port.
- 4 (Optional –Requires a video card with Audio port) - Connect one end of the Audio cable to the back of the monitor and connect the other end to the computer's Audio port.
- 5 (Optional–Requires a video card with DP port) –Connect one end of the DP cable to the back of the monitor and connect the other end to the computer's DP port.
- 6 Turn on your monitor and computer.
- 7 Video content supporting resolution:
 - VGA: 1920 x1080@60Hz (Maximum)
 - HDMI/DP: 1920x1080@144Hz (Maximum)

If your monitor displays an image, installation is complete. If it does not display an image, please refer Troubleshooting.

Wall Mounting

Preparing to Install An Optional Wall Mounting Arm.

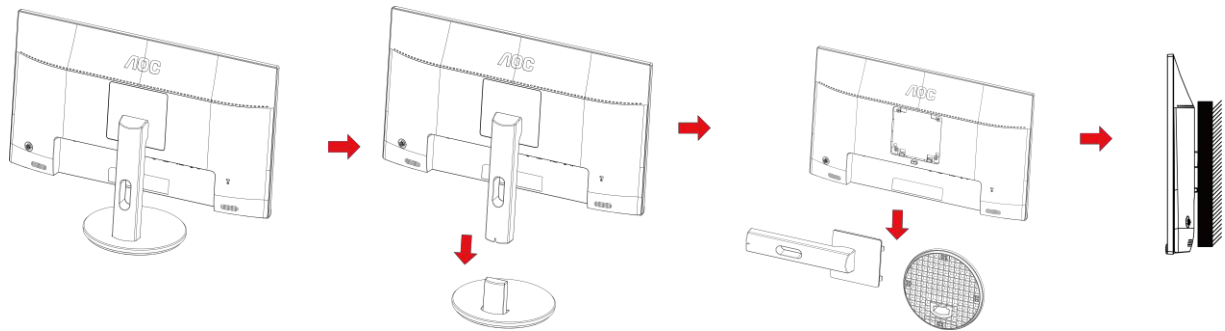

This monitor can be attached to a wall mounting arm you purchase separately. Disconnect power before this procedure. Follow these steps:

1. Remove the base.
2. Follow the manufacturer's instructions to assemble the wall mounting arm.
3. Place the wall mounting arm onto the back of the monitor. Line up the holes of the arm with the holes in the back of the monitor.
4. Insert the 4 screws into the holes and tighten.
5. Reconnect the cables. Refer to the user's manual that came with the optional wall mounting arm for instructions on attaching it to the wall.

Noted : VESA mounting screw holes are not available for all models, please check with the dealer or official department of AOC.

Free-Sync function

1. Free-Sync function is working with DP/HDMI1/HDMI2

- HDMI/DP : 30~144Hz

2. Compatible Graphics Card: Recommend list is as the below, also could be checked by visiting www.AMD.com

- AMD Radeon™ RX 480

- AMD Radeon™ RX 470

- AMD Radeon™ RX 460

Radeon Pro Duo

- AMD Radeon R9 300 Series

- AMD Radeon R9 Fury X

- AMD Radeon R9 360

- AMD Radeon R7 360

- AMD Radeon R9 295X2

- AMD Radeon R9 290X

- AMD Radeon R9 290

- AMD Radeon R9 285

- AMD Radeon R7 260X

- AMD Radeon R7 260

Adjusting

Setting Optimal Resolution

Windows 10

For Windows 10:

- Right click START.
- Click "**CONTROL PANEL**".

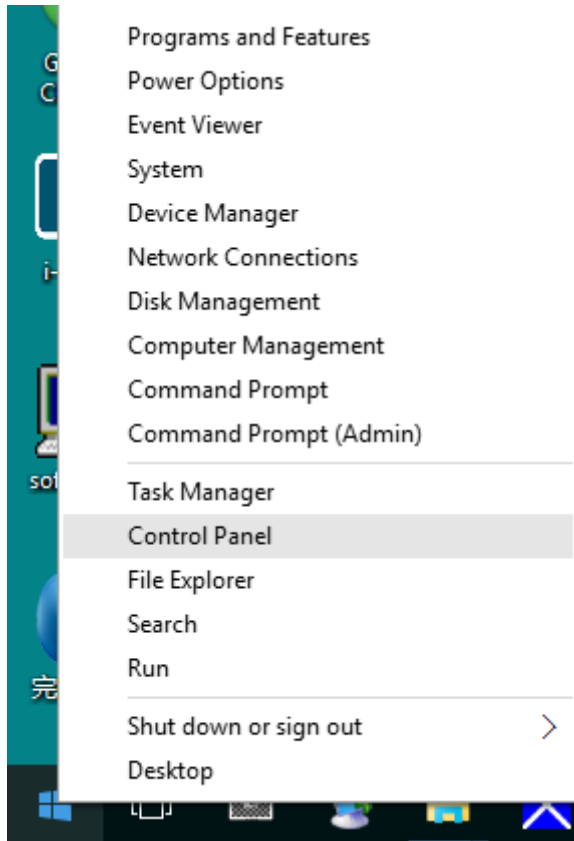

- Click "**DISPLAY**".

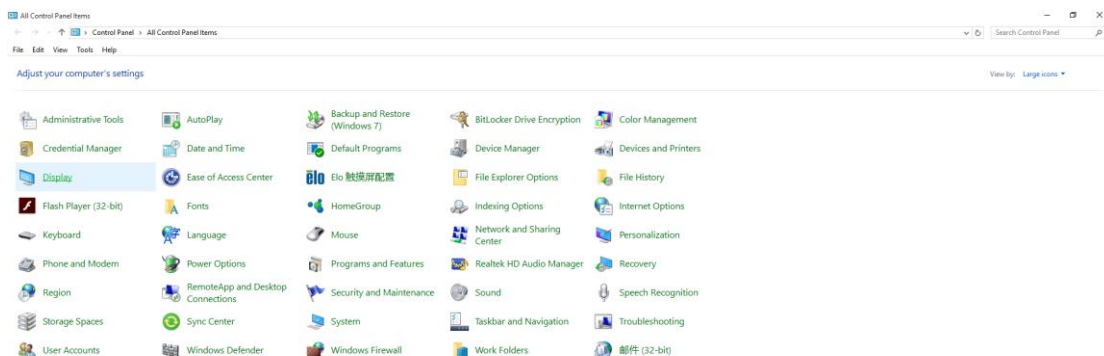

- Click on the "Change display settings" button.

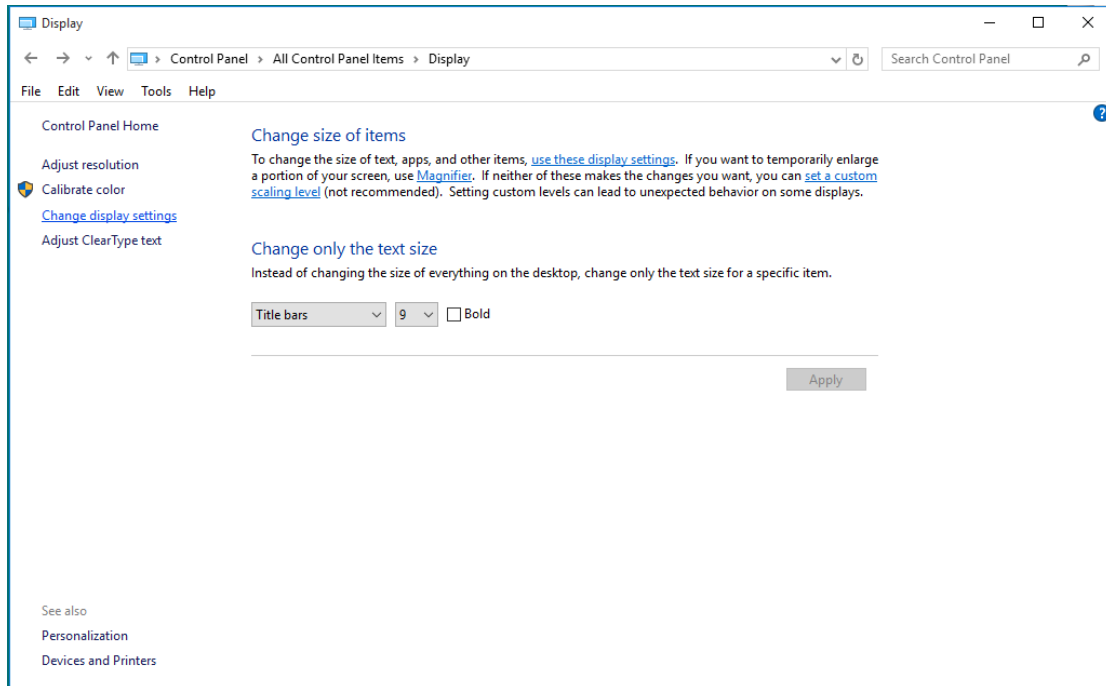

- Set the resolution **SLIDE-BAR** to Optimal preset resolution.

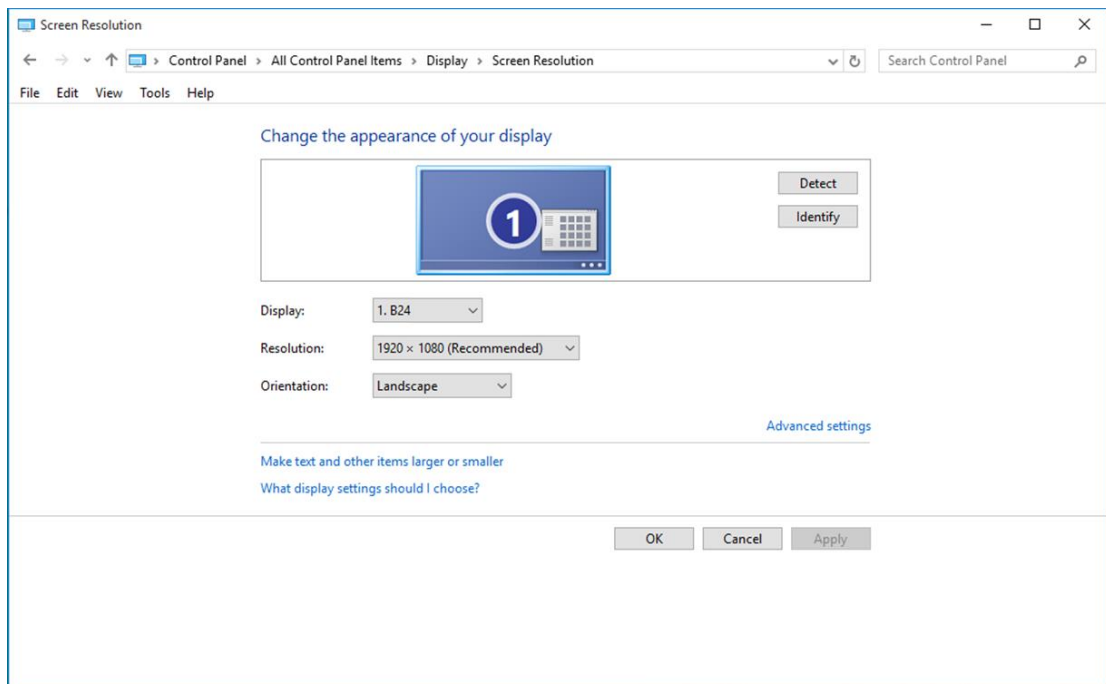

Windows 8

For Windows 8:

- Right click and click **All apps** at the bottom-right of the screen.

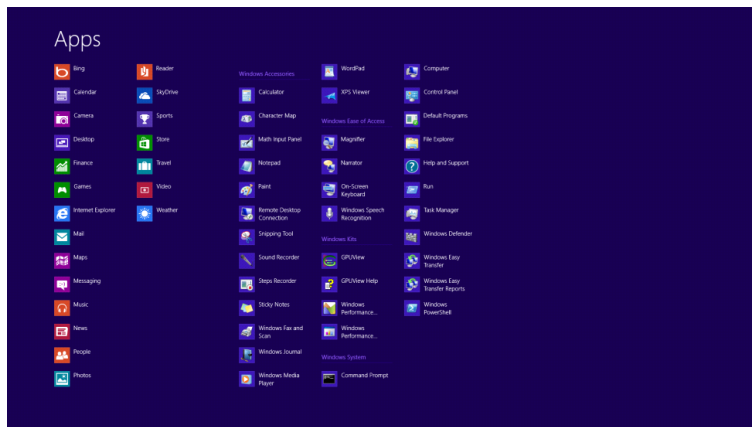
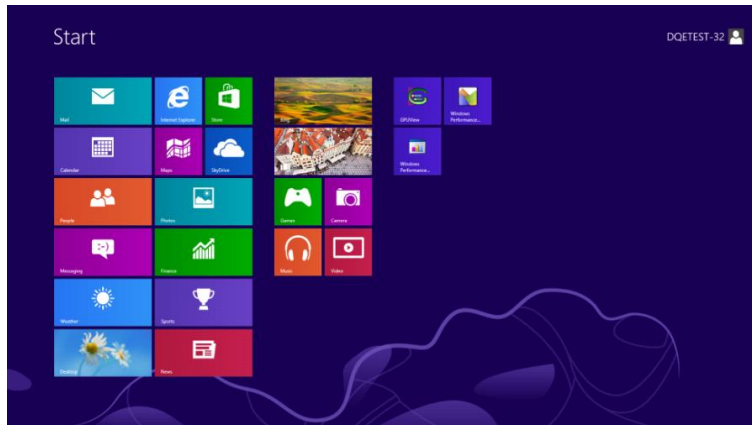

- Set the "View by" to "Category".
- Click "Appearance and Personalization".

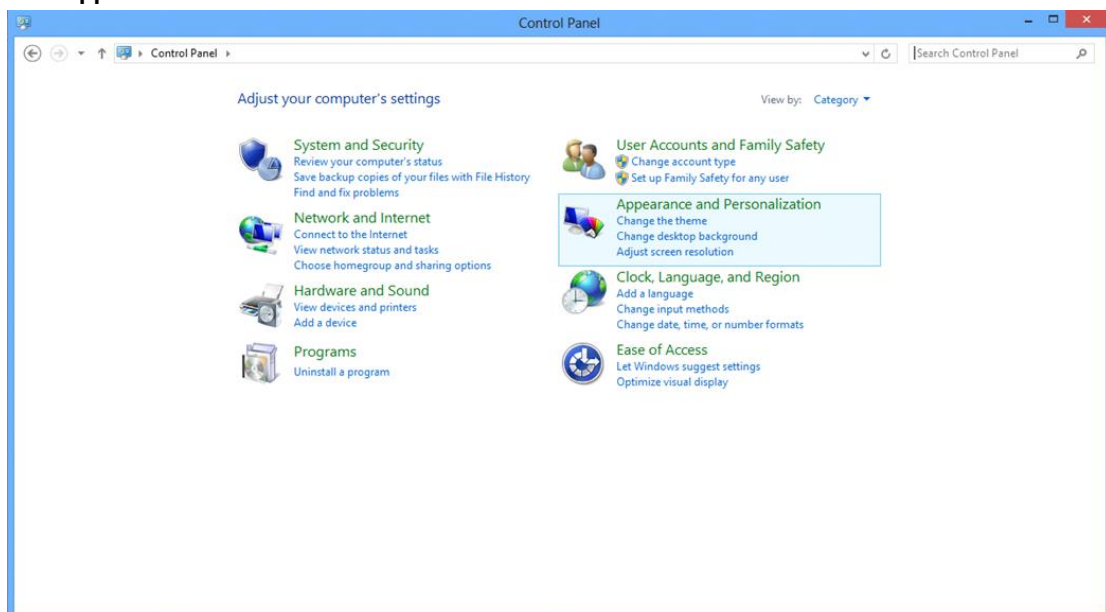

- Click "**DISPLAY**".

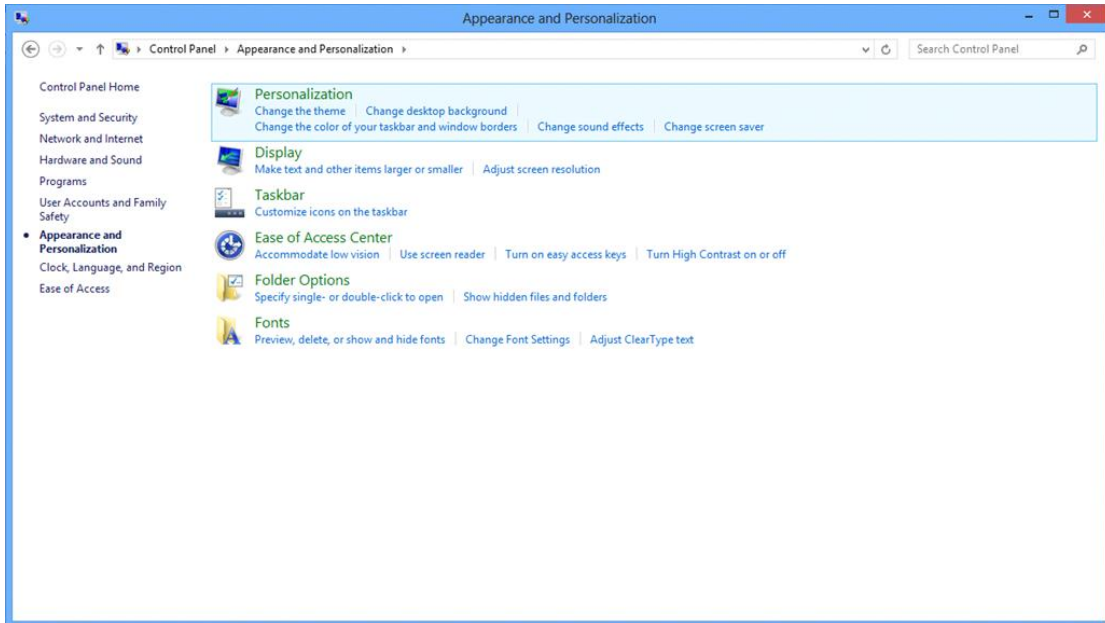

- Set the resolution **SLIDE-BAR** to Optimal preset resolution

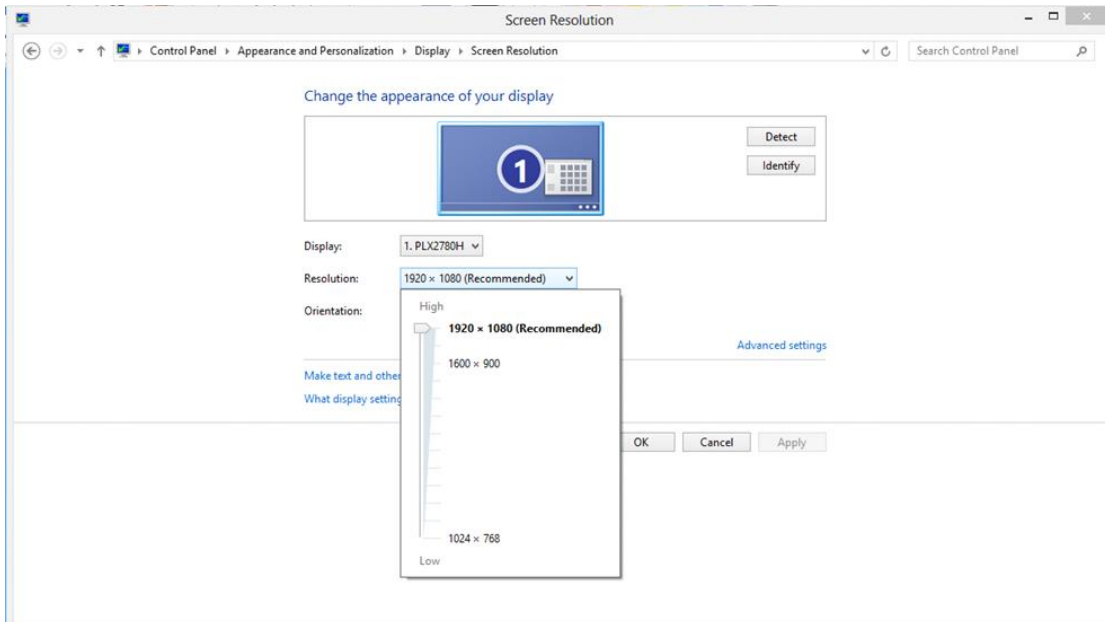

Windows 7

For Windows 7:

- Click **START**.
- Click **"CONTROL PANEL"**.

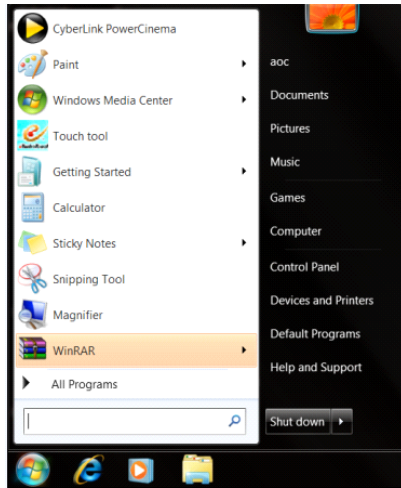

- Click **"Appearance"**.

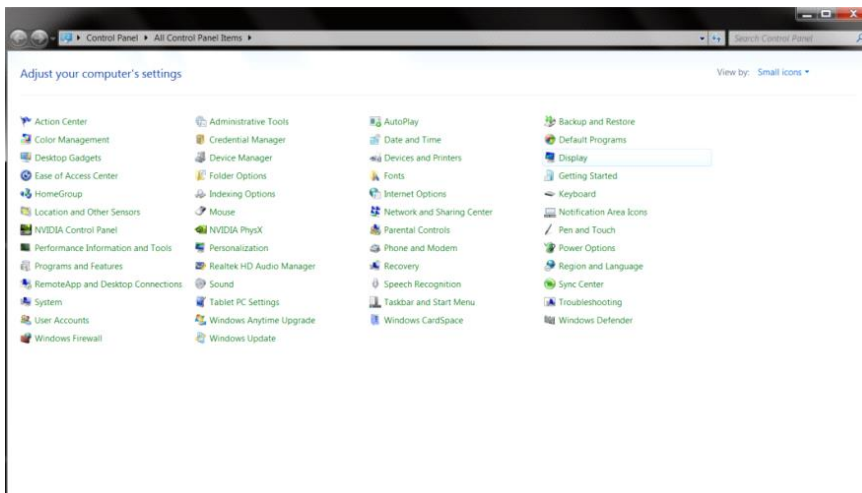

- Click **"DISPLAY"**.

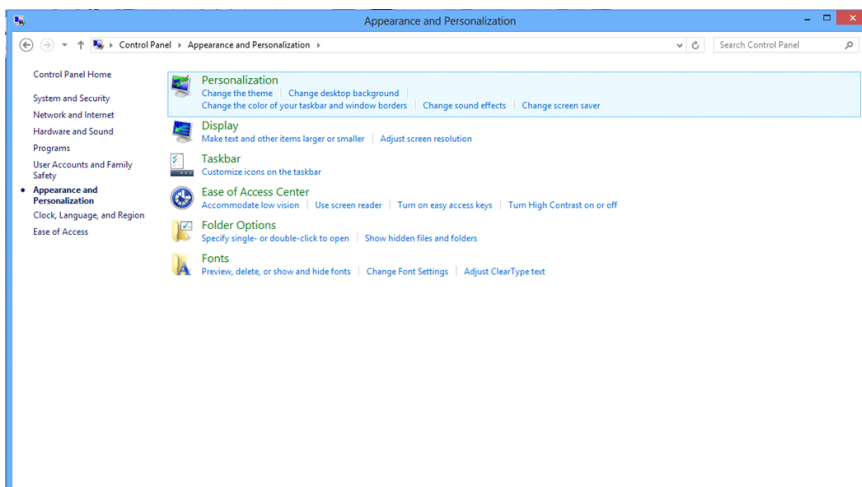

- Click on the "**Change display settings**" button.

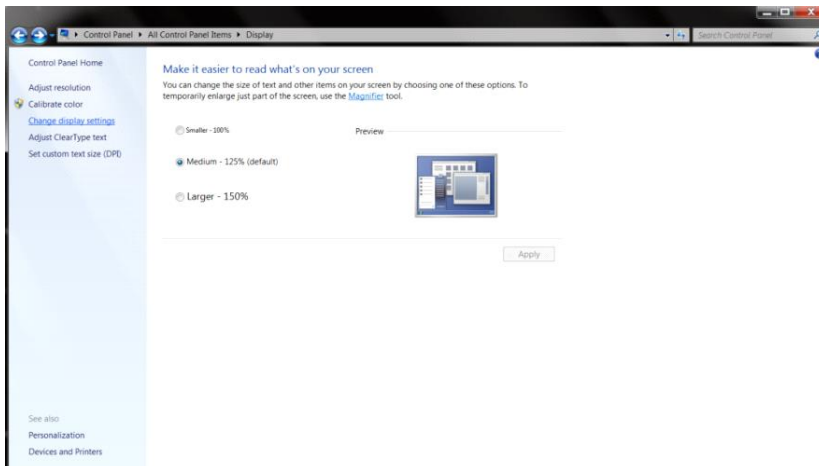

- Set the resolution **SLIDE-BAR** to Optimal preset resolution

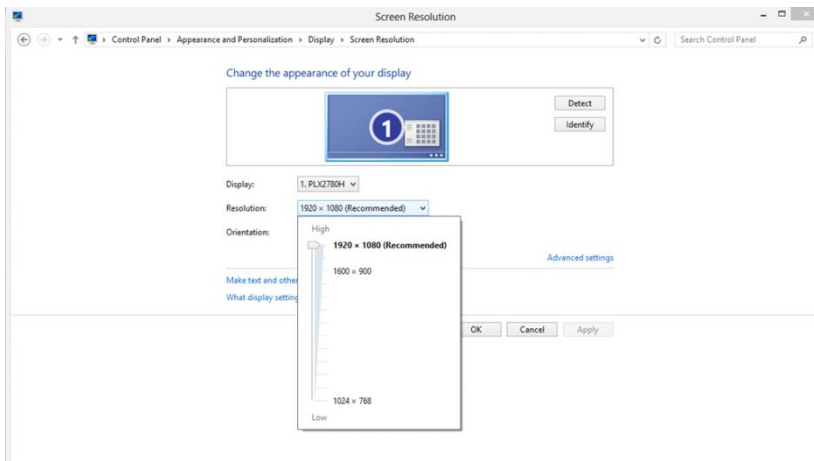

Hotkeys

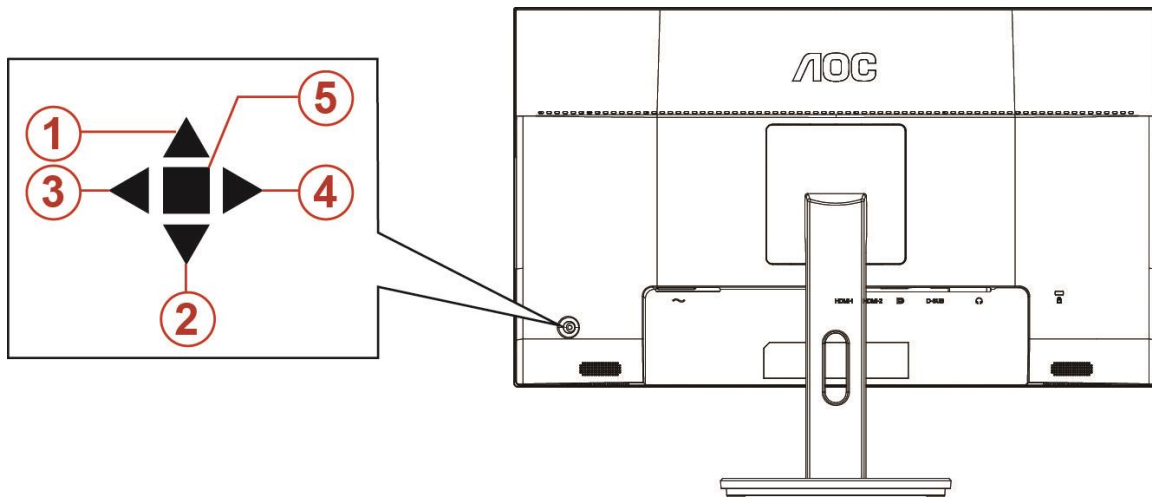

1	Source/Auto/Exit
2	Dial Point
3	Game Mode/Left
4	Image Ratio/Right
5	Power/ Menu/Enter

Power/Menu/Enter

Press the Power button to turn on the monitor.

When there is no OSD, Press to display the OSD or confirm the selection. Press about 2 second to turn off the monitor.

Dial Point

When there is no OSD, press Dial Point button to active Dial Point menu, and then press "Left" or "Right" to set Dial Point on or off.

Game Mode/Left

When there is no OSD, press "Left" key to open game mode function, then press "Left" or "Right" key to select game mode (FPS, RTS, Racing, Gamer 1, Gamer 2 or Gamer 3) basing on the different game types.

Image Ratio/Right

When there is no OSD, press "Right" key to select continuously to change image ratio.

Source/Auto/Exit

When the OSD is closed, press Source/Auto/Exit button will be Source hot key function. When the OSD is closed, press Source/Auto/Exit button continuously about 2 second to do auto configure (Only for the models with D-Sub).

OSD Setting

Basic and simple instruction on the control keys.



- 1) Press the **MENU-button** to activate the OSD window.
- 2) Press< or >to navigate through the functions. Once the desired function is highlighted, press the **MENU-button** to activate it. press< or >to navigate through the sub-menu functions. Once the desired function is highlighted, press **MENU-button** to activate it.
- 3) Press< or >to change the settings of the selected function. Press **AUTO-button** to exit. If you want to adjust any other function, repeat steps 2-3.
- 4) OSD Lock/Unlock Function: To lock or unlock the OSD, press and hold the **Down-button** for 10s while OSD function is not active.

Notes:

- 1) If the product has only one signal input, the item of "Input Select" is disable to adjust.
- 2) ECO modes (except Standard mode), DCR, DCB mode and Picture Boost, for these four states that only one state can exist.

Luminance



1. Press **MENU-button** to display menu.
2. Press Left or Right to select  (Luminance), and press **MENU-button** to enter.
3. Press Left or Right to select submenu, and press **MENU-button** to enter.
4. Press Left or Right to adjust.
5. Press **AUTO-button** to exit.









	Contrast	0-100		Contrast from Digital-register.
	Brightness	0-100		Backlight Adjustment
	Eco mode	Standard	<input checked="" type="checkbox"/>	Standard Mode
		Text		Text Mode
		Internet		Internet Mode
		Game		Game Mode
		Movie		Movie Mode
		Sports		Sports Mode
	Gamma	Gamma1	Adjust to Gamma 1	
		Gamma2	Adjust to Gamma 2	
		Gamma3	Adjust to Gamma 3	
	DCR	Off	Disable dynamic contrast ratio	
		On		Enable dynamic contrast ratio

Image Setup





1. Press **MENU-button** to display menu.
2. Press Left or Right to select  (Image Setup), and press **MENU-button** to enter.
3. Press Left or Right to select submenu, and press **MENU-button** to enter.
4. Press Left or Right to adjust.
5. Press **AUTO-button** to exit.

	Clock	0-100	Adjust picture Clock to reduce Vertical-Line noise.
	Phase	0-100	Adjust Picture Phase to reduce Horizontal-Line noise
	Sharpness	0-100	Adjust picture sharpness
	H. Position	0-100	Adjust the horizontal position of the picture.
	V. Position	0-100	Adjust the vertical position of the picture.

Color Setup





1. Press **MENU-button** to display menu.
2. Press Left or Right to select  (Color Setup), and press **MENU-button** to enter.
3. Press Left or Right to select submenu, and press **MENU-button** to enter.
4. Press Left or Right to adjust.
5. Press **AUTO-button** to exit.

	Color Temp.	Warm		Recall Warm Color Temperature from EEPROM.	
		Normal		Recall Normal Color Temperature from EEPROM.	
		Cool		Recall Cool Color Temperature from EEPROM.	
		sRGB		Recall sRGB Color Temperature from EEPROM.	
		User	Red		Red Gain from Digital-register
			Green		Green Gain Digital-register.
			Blue		Blue Gain from Digital-register
		DCB Mode	Full Enhance	on or off	Disable or Enable Full Enhance Mode
			Nature Skin	on or off	Disable or Enable Nature Skin Mode
	Green Field		on or off	Disable or Enable Green Field Mode	
	Sky-blue		on or off	Disable or Enable Sky-blue Mode	
	AutoDetect		on or off	Disable or Enable AutoDetect Mode	
	DCB Demo		On or off	Disable or Enable Demo	

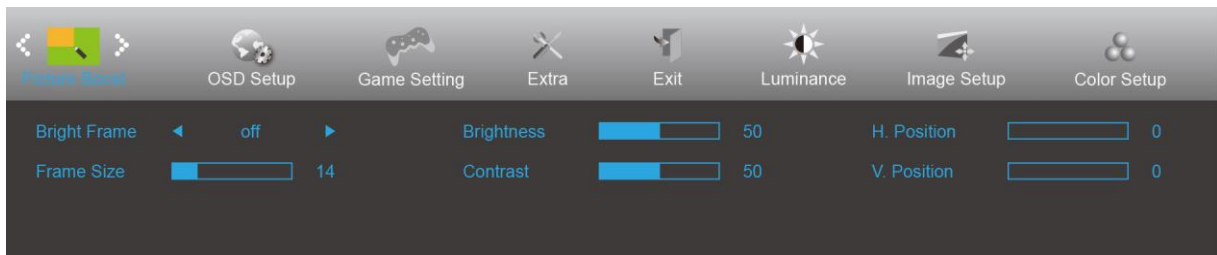
Picture Boost



1. Press **MENU-button** to display menu.
2. Press Left or Right to select  (Picture Boost), and press **MENU-button** to enter.
3. Press Left or Right to select submenu, and press **MENU-button** to enter.
4. Press Left or Right to adjust.
5. Press **AUTO-button** to exit.

	Bright Frame	on or off	Disable or Enable Bright Frame
	Frame Size	14-100	Adjust Frame Size
	Brightness	0-100	Adjust Frame Brightness
	Contrast	0-100	Adjust Frame Contrast
	H. position	0-100	Adjust Frame horizontal Position
	V. position	0-100	Adjust Frame vertical Position

Note:

Adjust the brightness, contrast, and position of the Bright Frame for better viewing experience.

OSD Setup

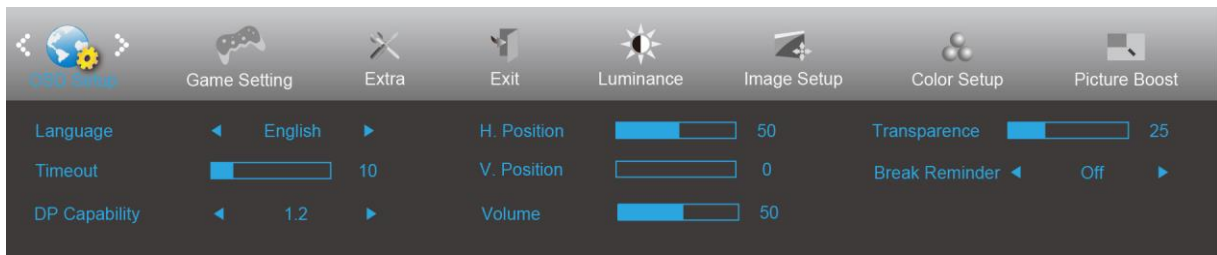

1. Press **MENU-button** to display menu.
2. Press Left or Right to select  (OSD Setup), and press **MENU-button** to enter.
3. Press Left or Right to select submenu, and press **MENU-button** to enter.
4. Press Left or Right to adjust.
5. Press **AUTO-button** to exit.

	Language		Select the OSD language
	Timeout	5-120	Adjust the OSD Timeout
	H. Position	0-100	Adjust the horizontal position of OSD
	V. Position	0-100	Adjust the vertical position of OSD
	Transparence	0-100	Adjust the transparence of OSD
	Break Reminder	on or off	Break reminder if the user continuously work for more than 1hrs
	DP Capability	1.1/1.2	please be noted that only DP1.2 support free sync function
	Volume	0-100	Volume Adjustment.

Notes:

If the DP video content supports DP1.2, please select DP1.2 for DP Capability; otherwise, please select DP1.1

Game Setting

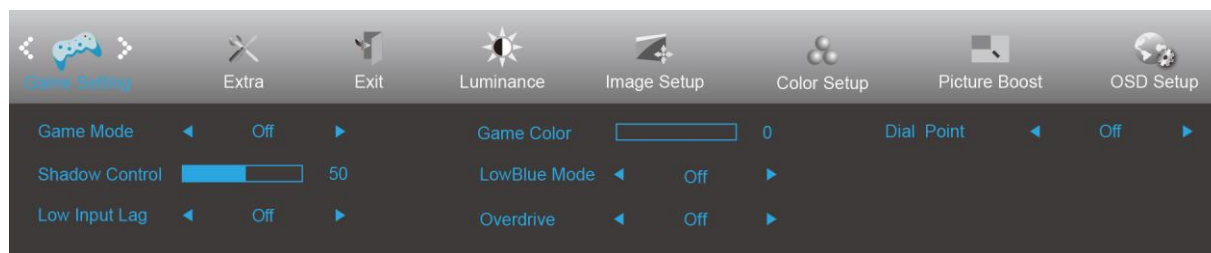



1. Press **MENU-button** to display menu.
2. Press Left or Right to select  (Game setting), and press **MENU-button** to enter.
3. Press Left or Right to select submenu, and press **MENU-button** to enter.
4. Press Left or Right to adjust.
5. Press **AUTO-button** to exit.

	Game Mode	FPS	For playing FPS (first Person Shooters) games. Improves dark theme black level details.
		RTS	For playing RTS (Real Time Strategy). Improves the image quality.
		Racing	For playing Racing games, Provides fastest response time and high color saturation.
		Gamer 1	User's preference settings saved as Gamer 1.
		Gamer 2	User's preference settings saved as Gamer 2.
		Gamer 3	User's preference settings saved as Gamer 3.
		off	No optimization by Smart image game
	Shadow Control	0-100	Shadow Control Default is 50, then end-user can adjust from 50 to 100 or 0 to increase contrast for clear picture. 1. If picture is too dark to be saw the detail clearly, adjusting from 50 to 100 for clear picture.. 2. If picture is too white to be saw the detail clearly, adjusting from 50 to 0 for clear picture
	Low input Lag	On/off	Turn off frame buffer to decrease input lag
	Game Color	0-20	Game Color will provide 0-20 level for adjusting saturation to get better picture.
	LowBlue Mode	Off/Weak/ Medium/Strong	Decrease blue light wave by controlling color temperature.
	Overdrive	Weak	Adjust the response time.
Medium			
Strong			
Off			
Dial Point	On/Off	The "Dial Point" function places an aiming indicator in the center of screen for helping gamers to play First Person Shooter (FPS) games with an accurate and precise aiming.	

Extra



1. Press **MENU-button** to display menu.
2. Press Left or Right to select  (Extra), and press **MENU-button** to enter.
3. Press Left or Right to select submenu, and press **MENU-button** to enter.
4. Press Left or Right to adjust.
5. Press **AUTO-button** to exit.

	Input Select	AUTO/D-SUB/HDMI1/HDMI2 /DP	Select Input Signal Source
	Auto Config	yes or no	Auto adjust the picture to default
	Off timer	0-24hrs	Select DC off time
	Image Ratio	Wide	Select image ratio for display.
		1:1	
		4:3	
		17" (4:3)	
		19" (4:3)	
		19" (5:4)	
		19"W (16:10)	
		21.5"W (16:9)	
22"W (16:10)			
23"W (16:9)			
23.6"W (16:9)			
24"W (16:9)			
DDC-CI	yes or no	Turn ON/OFF DDC-CI Support	
Reset	Yes or no	Reset the menu to default	

Exit

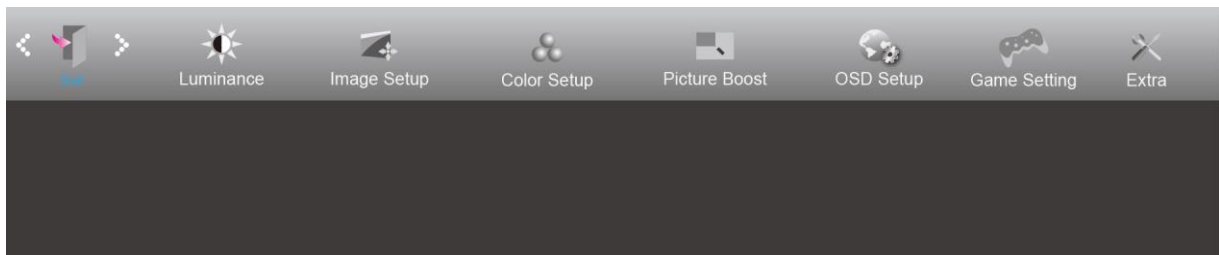

1. Press **MENU-button** to display menu.
2. Press Left or Right to select  (Exit), and press **MENU-button** to enter.
3. Press **AUTO-button** to exit.

	Exit		Exit the main OSD
---	------	--	-------------------

LED Indicator

Status	LED Color
Full Power Mode	White
Active-off Mode	Orange

Driver

Monitor Driver

Windows 10

- Start Windows® 10
- Right click START.
- Click "**Control Panel**".

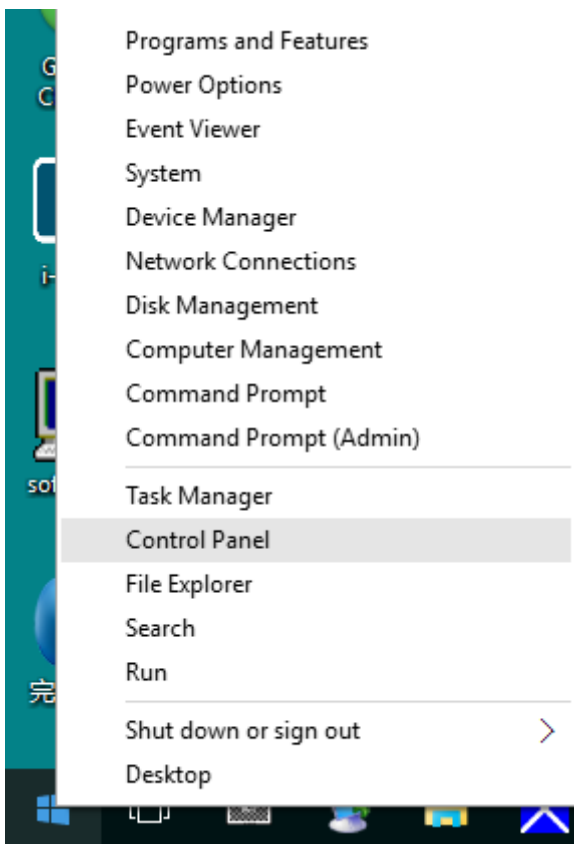

- Click on the "**Display**" icon.

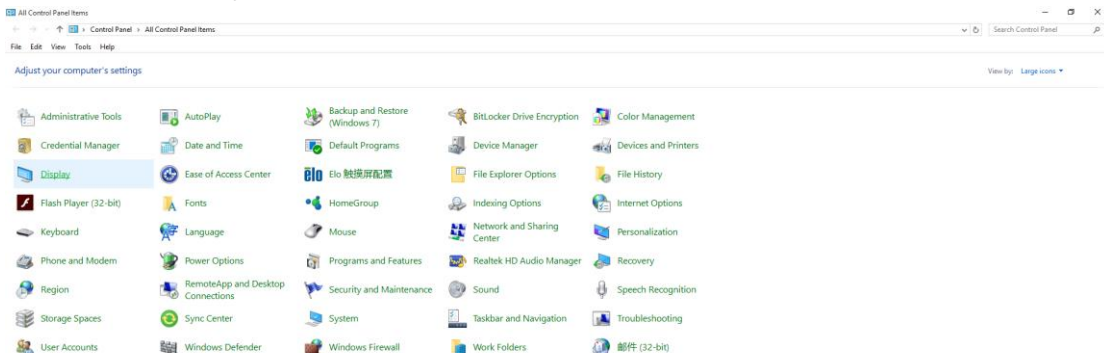

- Click on the "Change display settings" button

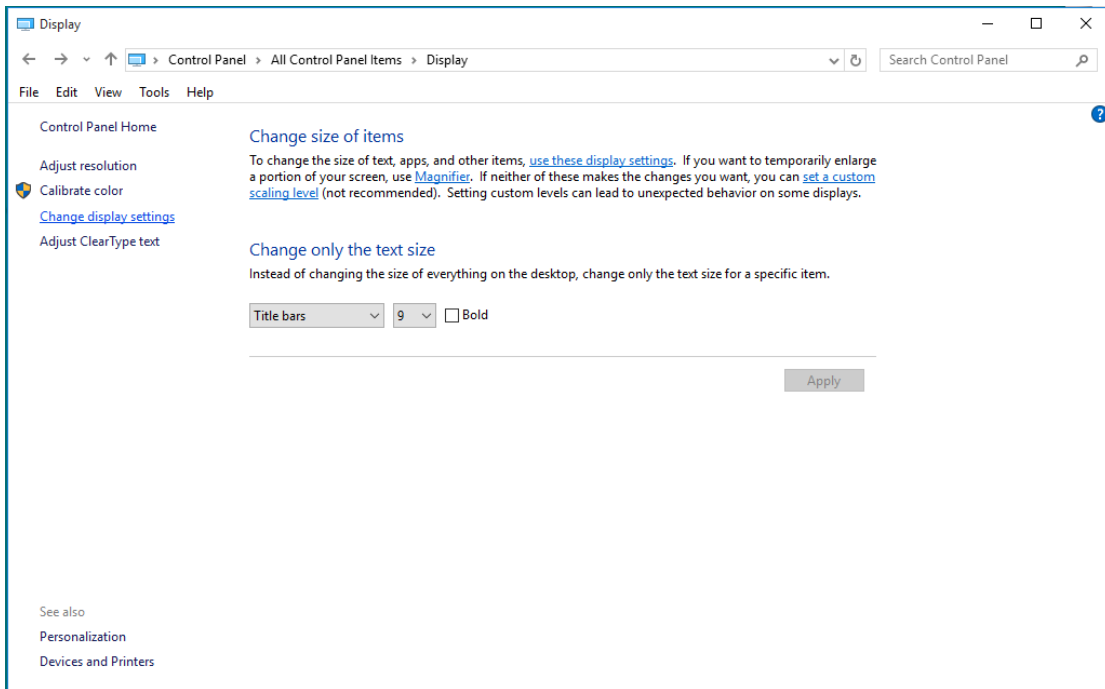

- Click the "AdvancedSettings" button.

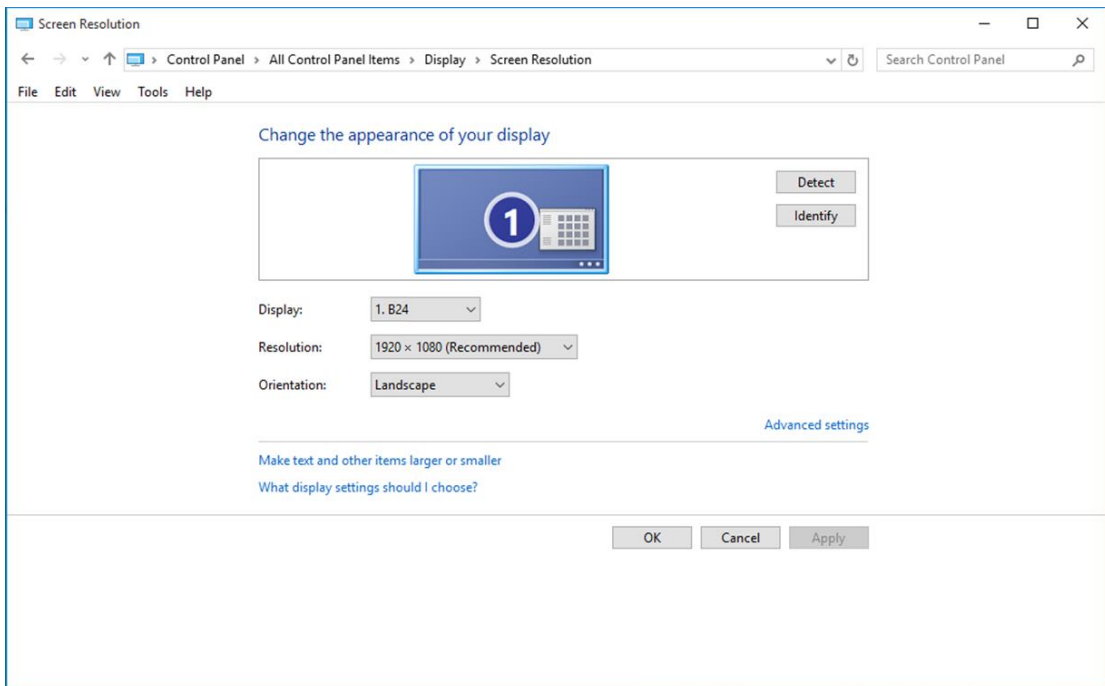

- Click the "**Monitor**" tab and then click the "**Properties**" button.

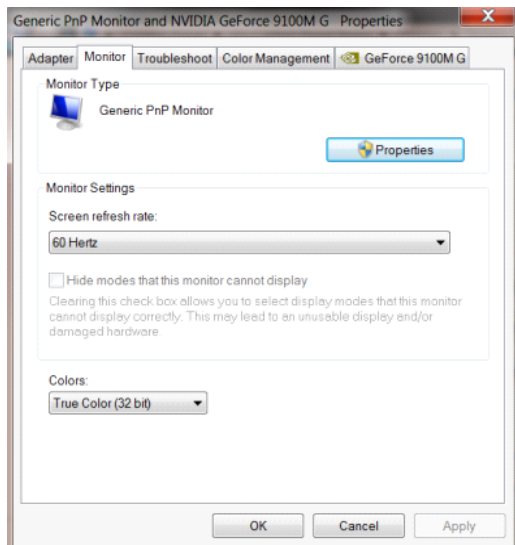

- Click the "**Driver**" tab.

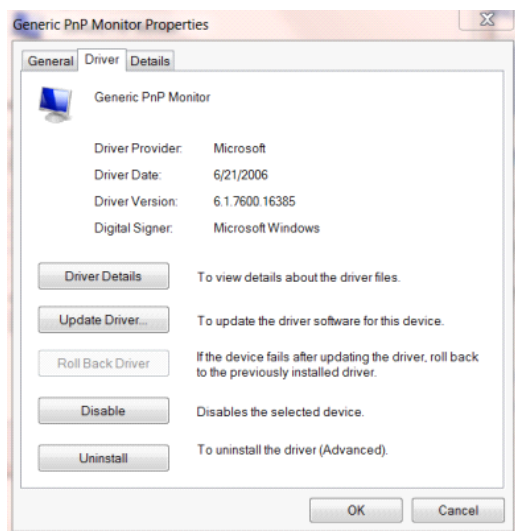

- Open the "Update Driver Software-Generic PnP Monitor" window by clicking on "**Update Driver...**" "and then click the "**Browse my computer for driver software**" button.

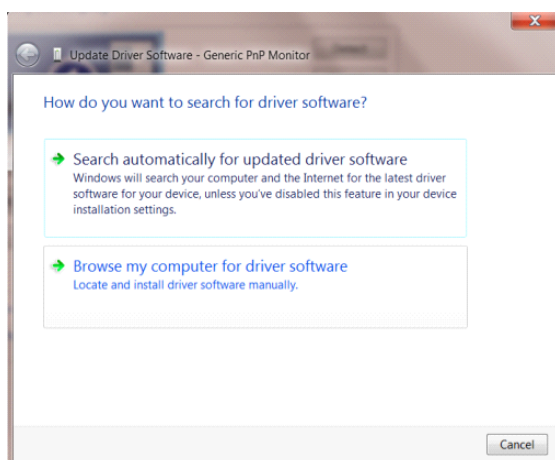

- Select **"Let me pick from a list of device drivers on my computer"**.

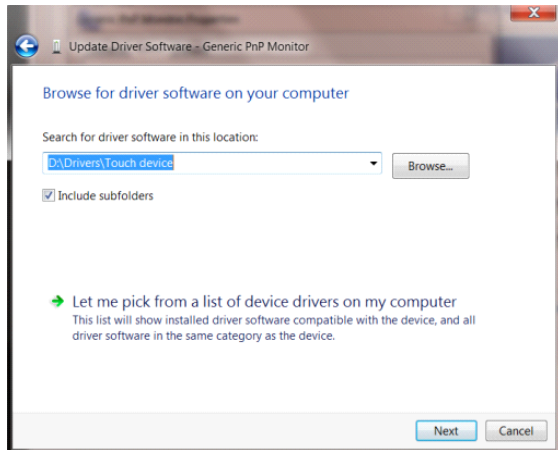

- Click the **"Have Disk"** button. Click on the **"Browse"** button and navigate to the following directory:
X:\Driver\module name(where X is the drive letter designator for the CD-ROM drive).

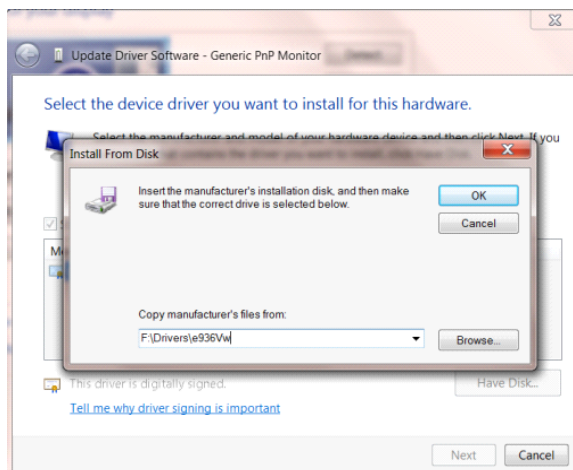

- Select the **"xxx.inf"** file and click the **"Open"** button. Click the **"OK"** button.
- Select your monitor model and click the **"Next"** button. The files will be copied from the CD to your hard disk drive.
- Close all open windows and remove the CD.
- Restart the system. The system will automatically select the maximum refresh rate and corresponding Color Matching Profiles.

- Click on the "**Display**" icon.

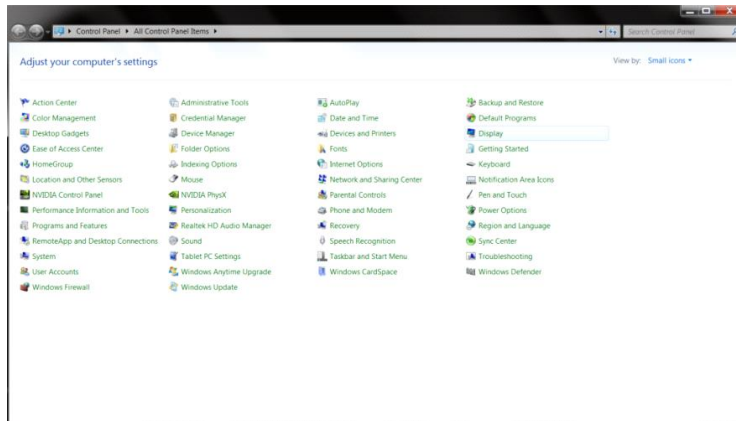

- Click on the "**Change display settings**" button.

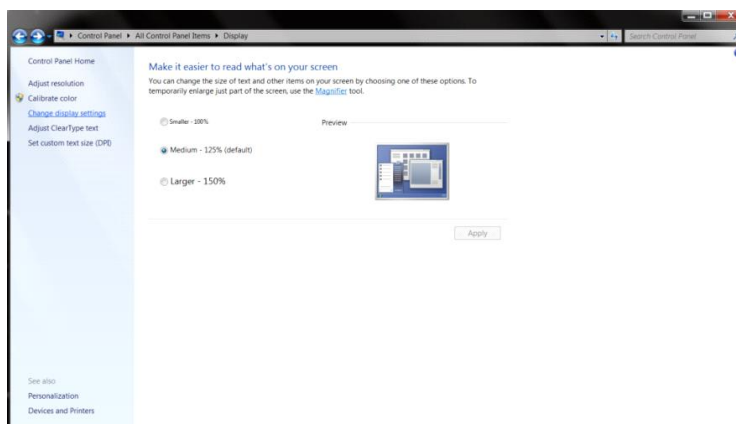

- Click the "**Advanced Settings**" button.

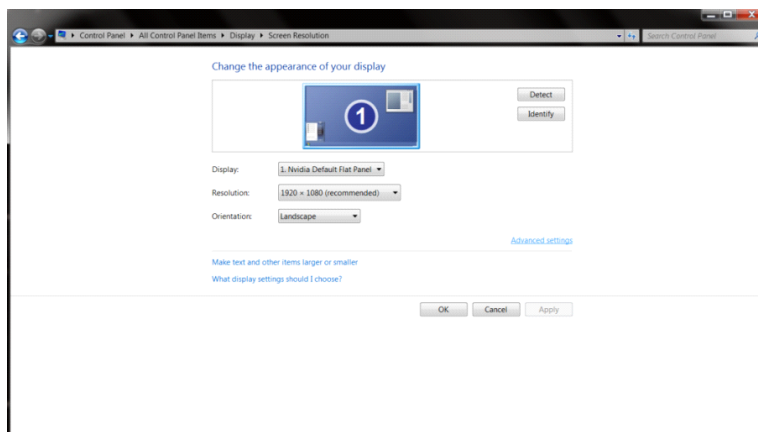

- Click the "**Monitor**" tab and then click the "**Properties**" button.

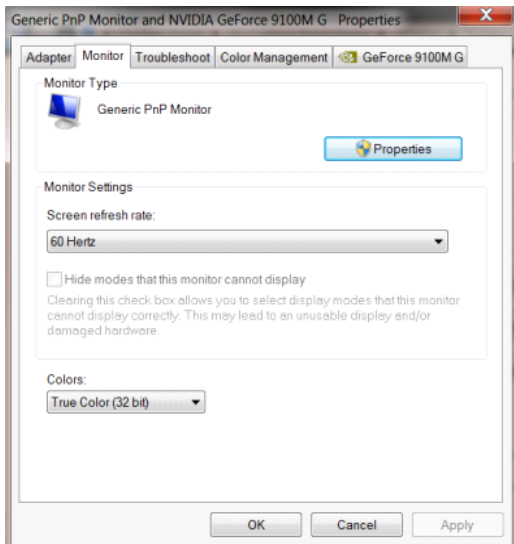

- Click the "Driver" tab.

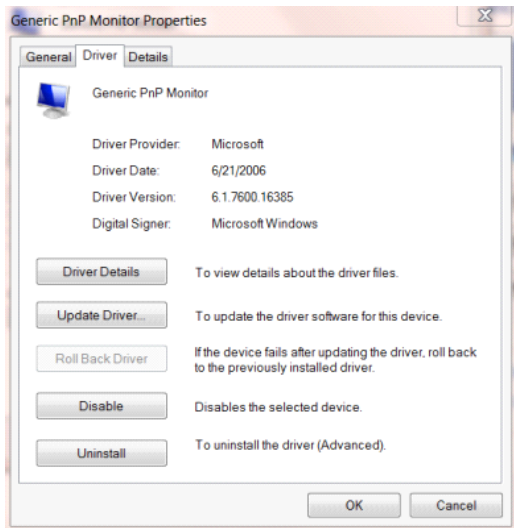

- Open the "Update Driver Software-Generic PnP Monitor" window by clicking on "Update Driver..." and then click the "Browse my computer for driver software" button.

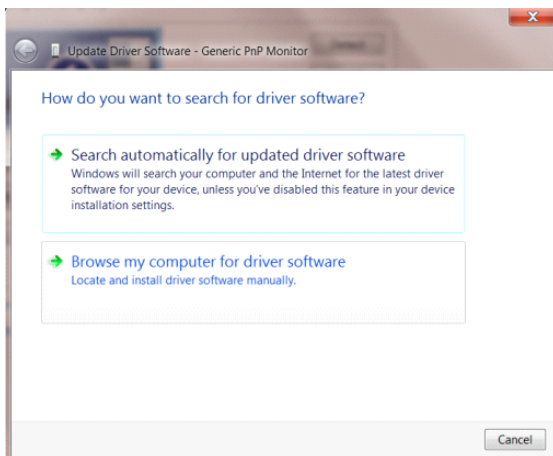

- Select **"Let me pick from a list of device drivers on my computer"**.

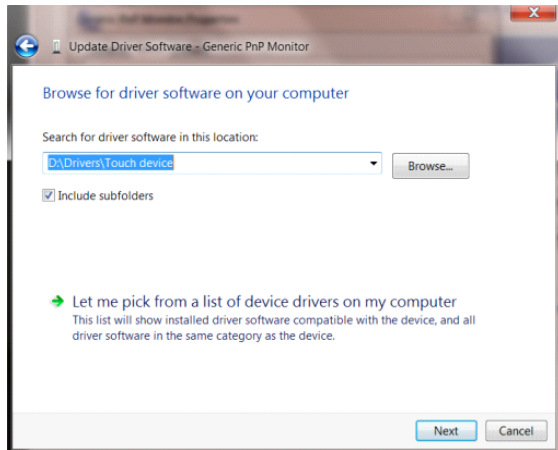

- Click the **"Have Disk"** button. Click on the **"Browse"** button and navigate to the following directory:
X:\Driver\module name (where X is the drive letter designator for the CD-ROM drive).

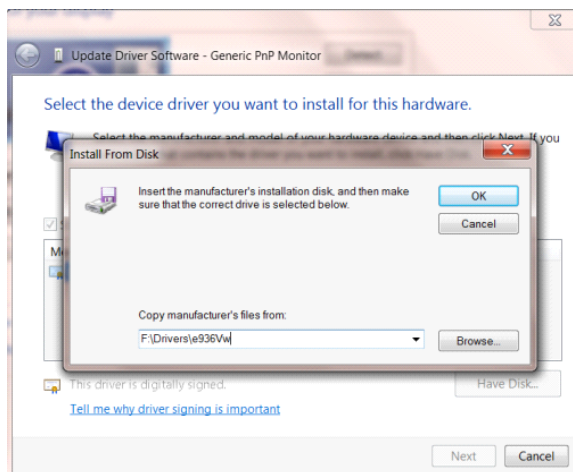

- Select the **"xxx.inf"** file and click the **"Open"** button. Click the **"OK"** button.
- Select your monitor model and click the **"Next"** button. The files will be copied from the CD to your hard disk drive.
- Close all open windows and remove the CD.
- Restart the system. The system will automatically select the maximum refresh rate and corresponding Color Matching Profiles.

Windows 7

- Start Windows® 7
- Click on the "**Start**" button and then click on "**Control Panel**".

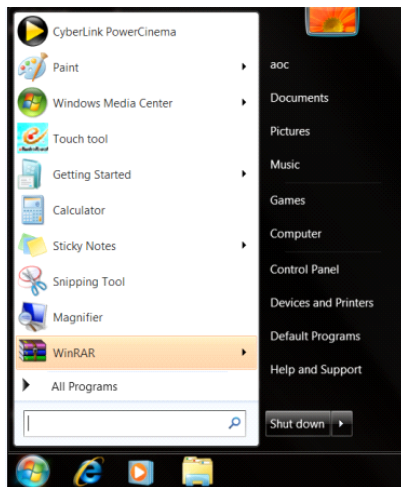

- Click on the "**Display**" icon.

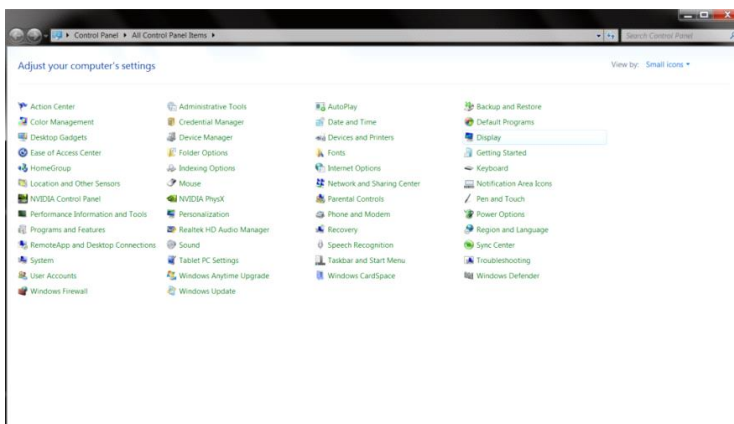

- Click on the "**Change display settings**" button.

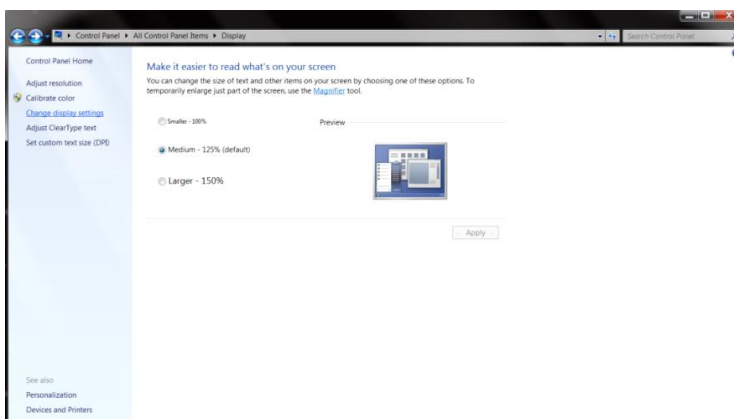

- Click the **"Advanced Settings"** button.

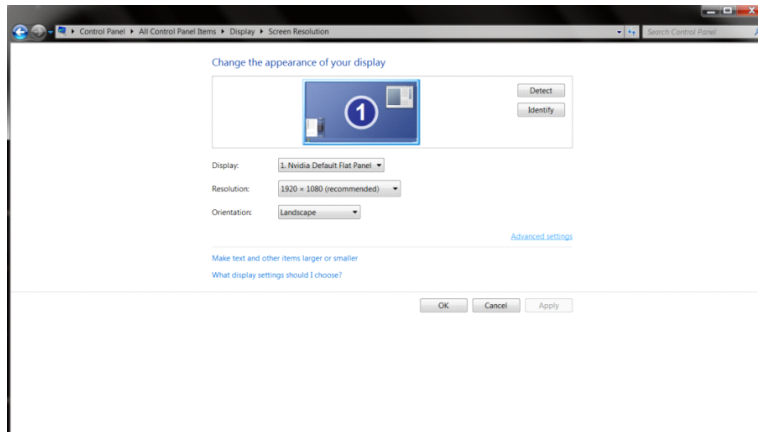

- Click the **"Monitor"** tab and then click the **"Properties"** button.

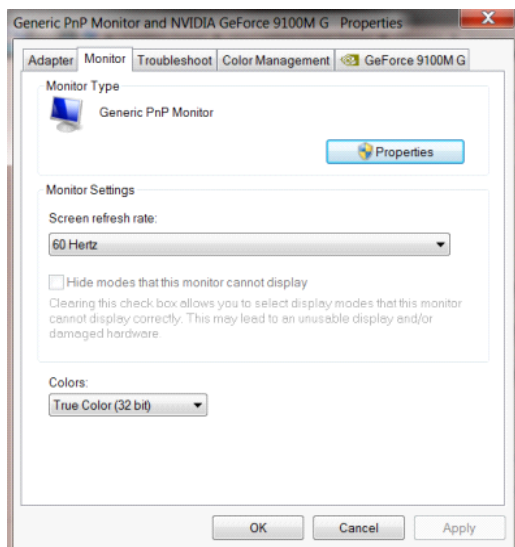

- Click the **"Driver"** tab.

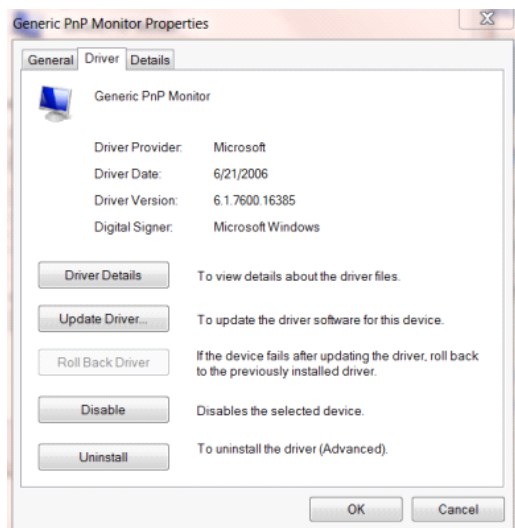

- Open the **"Update Driver Software-Generic PnP Monitor"** window by clicking on **"Update Driver..."** and then click the **"Browse my computer for driver software"** button.

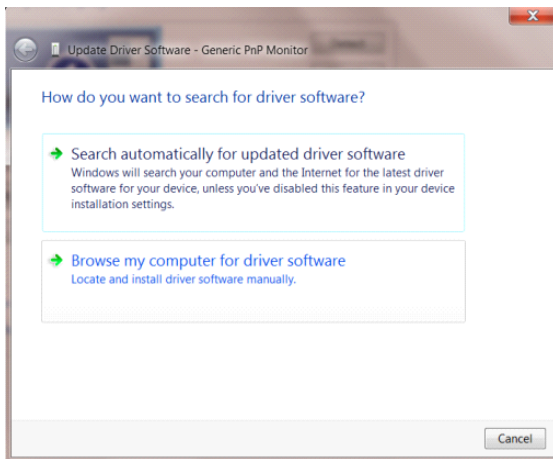

- Select "**Let me pick from a list of device drivers on my computer**".

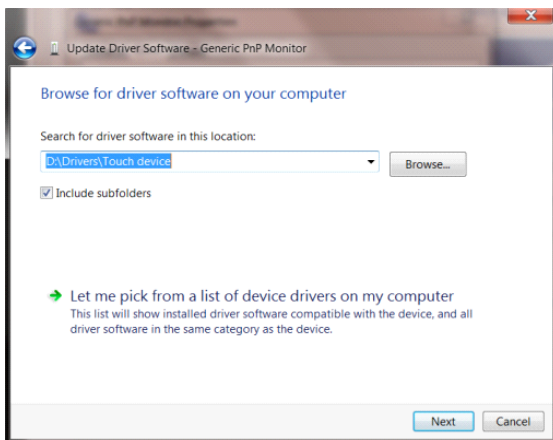

- Click the "**Have Disk**" button. Click on the "**Browse**" button and navigate to the following directory:
X:\Driver\module name(where X is the drive letter designator for the CD-ROM drive).

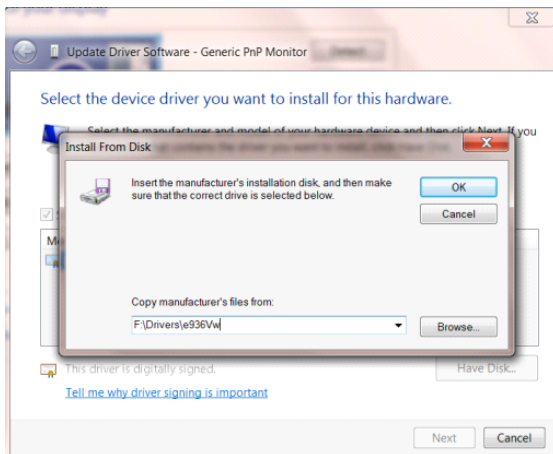

- Select the "**xxx.inf**" file and click the "**Open**" button. Click the "**OK**" button.
- Select your monitor model and click the "**Next**" button. The files will be copied from the CD to your hard disk drive.
- Close all open windows and remove the CD.
- Restart the system. The system will automatically select the maximum refresh rate and corresponding Color Matching Profiles.

i-Menu



Welcome to "i-Menu" software by AOC. i-Menu makes it easy to adjust your monitor display setting by using on screen menus instead of the OSD button on the monitor. To complete installation, please follow the installation guide. The software Supported operating systems: Windows 10, Windows 8, Windows 7.



e-Saver



Welcome to use AOC e-Saver monitor power management software! The AOC e-Saver features Smart Shutdown functions for your monitors, allows your monitor to timely shutdown when PC unit is at any status (On, Off, Sleep or Screen Saver); the actual shutdown time depends on your preferences (see example below).

Please click on "driver/e-Saver/setup.exe" to start installing the e-Saver software, follow the install wizard to complete software installation.

Under each of the four PC status, you may choose from the pull-down menu the desired time (in minutes) you're your monitor to automatically shut down. The example above illustrated:

- 1) The monitor will never shutdown when the PC is powered on.
- 2) The monitor will automatically shutdown 5 minutes after the PC is powered off.
- 3) The monitor will automatically shutdown 10 minutes after the PC is in sleep/stand-by mode.
- 4) The monitor will automatically shutdown 20 minutes after the screen saver appears.

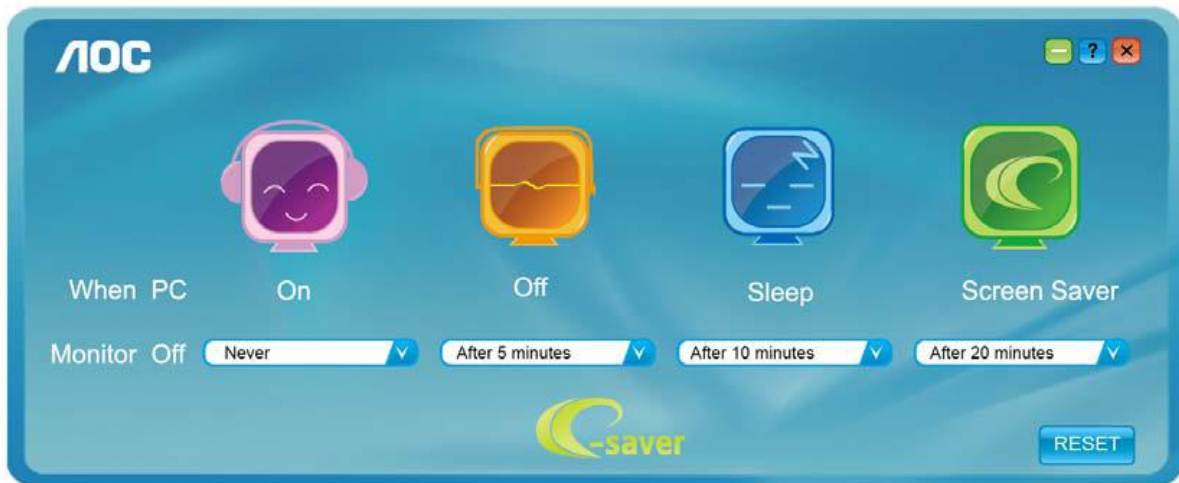

You can click "RESET" to set the e-Saver to its default settings like below.

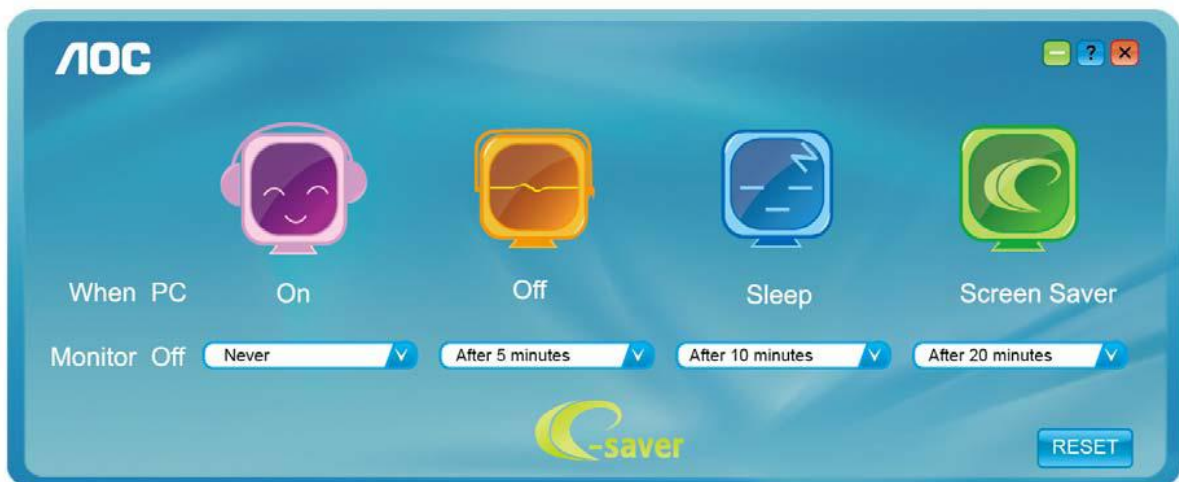

Screen+



Welcome to “Screen+” software by AOC. Screen+ software is a desktop screen splitting tool; it splits the desktop into different panels, and each panel displays a different window. You only need to drag the window to a corresponding panel when you want to access it. It supports multiple monitor display to make your task easier. Please follow the installation software to install it. The software Supported operating systems: Windows 10, Windows 8, Windows 7.

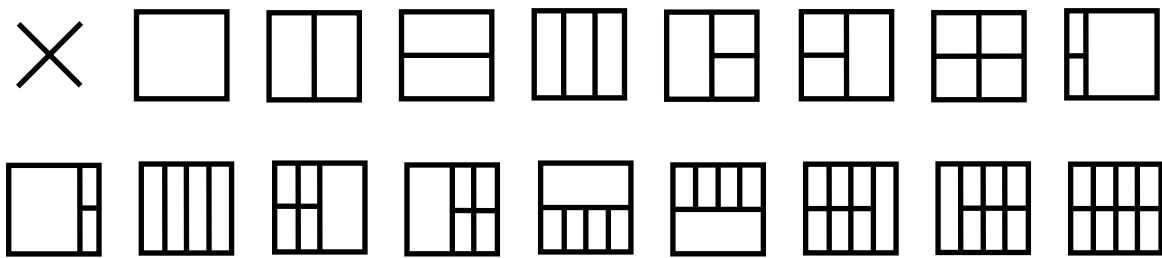

Troubleshoot

Problem & Question	Possible Solutions
Power LED Is Not ON	Make sure the power button is ON and the Power Cord is properly connected to a grounded power outlet and to the monitor.
No images on the screen	<ul style="list-style-type: none"> • Is the power cord connected properly? Check the power cord connection and power supply. • Is the cable connected correctly? (Connected using the D-sub cable) Check the DB-15 cable connection. (Connected using the DVI cable) Check the DVI cable connection. * DVI input is not available on every model. • If the power is on, reboot the computer to see the initial screen (the login screen), which can be seen. If the initial screen (the login screen) appears, boot the computer in the applicable mode (the safe mode for Windows ME/XP/2000) and then change the frequency of the video card. (Refer to the Setting the Optimal Resolution) If the initial screen (the login screen) does not appear, contact the Service Center or your dealer. • Can you see "Input Not Supported" on the screen? You can see this message when the signal from the video card exceeds the maximum resolution and frequency that the monitor can handle properly. Adjust the maximum resolution and frequency that the monitor can handle properly. • Make sure the AOC Monitor Drivers are installed.
Picture Is Fuzzy & Has Ghosting Shadowing Problem	Adjust the Contrast and Brightness Controls. Press to auto adjust. Make sure you are not using an extension cable or switch box. We recommend plugging the monitor directly to the video card output connector on the back.
Picture Bounces, Flickers Or Wave Pattern Appears In The Picture	Move electrical devices that may cause electrical interference as far away from the monitor as possible. Use the maximum refresh rate your monitor is capable of at the resolution you are using.
Monitor Is Stuck In Active Off-Mode"	The Computer Power Switch should be in the ON position. The Computer Video Card should be snugly fitted in its slot. Make sure the monitor's video cable is properly connected to the computer. Inspect the monitor's video cable and make sure no pin is bent. Make sure your computer is operational by hitting the CAPS LOCK key on the keyboard while observing the CAPS LOCK LED. The LED should either turn ON or OFF after hitting the CAPS LOCK key.
Missing one of the primary colors (RED, GREEN, or BLUE)	Inspect the monitor's video cable and make sure that no pin is damaged. Make sure the monitor's video cable is properly connected to the computer.
Screen image is not centered or sized properly	Adjust H-Position and V-Position or press hot-key (AUTO).
Picture has color defects (white does not look white)	Adjust RGB color or select desired color temperature.
Horizontal or vertical disturbances on the screen	Use Windows 95/98/2000/ME/XP shut-down mode to adjust CLOCK and FOCUS. Press to auto-adjust.

Specification

General Specification

Panel	Model name	G2590FX		
	Driving system	TFT Color LCD		
	Viewable Image Size	24.5 inch, 62.228 cm diagonal		
	Pixel pitch	0.2832mm(H) x 0.2802mm(V)		
	Video	R, G, B Analog Interface & HDMI Interface & DP Interface		
	Separate Sync.	H/V TTL		
	Display Color	16.7M Colors		
Others	Horizontal scan range	30k~160kHz(D-SUB/HDMI1.4) 160kHz(DP)		
	Horizontal scan Size(Maximum)	543.744mm		
	Vertical scan range	50~146Hz(D-SUB) 30~146Hz(HDMI1.4/DP)		
	Vertical Scan Size(Maximum)	302.616mm		
	Optimal preset resolution	1920x1080@60Hz(D-SUB) 1920x1080@144Hz (HDMI/DP) Notice:" low input lag" used above 120 Hz frequency the effect is better.		
	Plug & Play	VESA DDC2B/CI		
	Input Connector	VGA /HDMI/DP		
	Input Video Signal	Analog: 0.7Vp-p(standard), 75 OHM, TMDS		
	Output Connector	Earphone out		
	Power Source	100-240V~,50/60Hz		
	Power Consumption	Typical(Brightness = 90,Contrast = 50)	34W	
		Max. (brightness = 100, contrast =100)	≤23W	
Power saving		≤0.5W		
Off timer	0~24 hrs			
Physical Characteristics	Connector Type	VGA\ HDMI\DP\Earphone out		
	Signal Cable Type	Detachable		
	Dimensions & Weight:			
	Height(with Base)	419.8mm		
	Width	558.6mm		
	Depth	179.5mm		
	Weight(Monitor only)	4.27Kg		
Environmental	Temperature	Operating	0°~ 40°	
		Non-Operating	-25°~ 55°	
	Humidity	Operating	10% ~ 85% (non-condensing)	
		Non-Operating	5% ~ 93% (non-condensing)	
	Altitude	Operating	0~ 5000 m (0~ 16404ft)	
		Non-Operating	0~ 12192m (0~ 40000ft)	

Preset Display Modes

STANDARD	RESOLUTION	HORIZONTAL FREQUENCY(KHZ)	HORIZONTAL FREQUENCY(Hz)	SOURCE
VGA	640x480@60Hz	31.469	59.94	ALL
	640x480@72Hz	37.861	72.809	ALL
	640x480@75Hz	37.5	75	ALL
	640x480@67Hz	35	66.667	ALL
	640x480@100Hz	51.08	99.769	ALL
	640x480@120Hz	61.91	119.518	ALL
Dos	720x400@70Hz	31.469	70.087	ALL
SVGA	800x600@56Hz	35.156	56.25	ALL
	800x600@60Hz	37.879	60.317	ALL
	800x600@72Hz	48.077	72.188	ALL
	800x600@75Hz	46.875	75	ALL
	800x600@100Hz	63.68	99.662	ALL
	800x600@120Hz	77.43	119.854	ALL
XGA	1024x768@60Hz	48.363	60.004	ALL
	1024x768@70Hz	56.476	70.069	ALL
	1024x768@75Hz	60.023	75.029	ALL
	1024x768@100Hz	81.58	99.972	ALL
	1024x768@120Hz	98.96	119.804	ALL
SXGA	1280x1024@60Hz	63.981	60.02	ALL
	1280x1024@75Hz	79.976	75.025	ALL
Full HD	1920x1080@60Hz	67.5	60	ALL
	1920x1080@100Hz	114.6	99.898	HDMI/DP
	1920x1080@120Hz	139.1	119.93	HDMI/DP
	1920x1080@144Hz	158.1	144	HDMI/DP

Pin Assignments

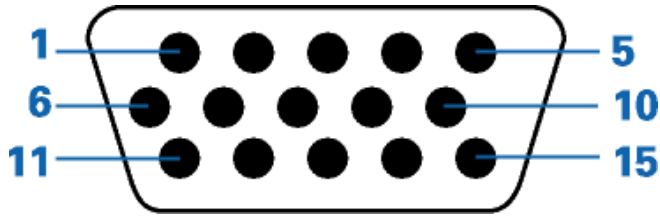

15-Pin Color Display Signal Cable

Pin Number	15-Pin Side of the Signal Cable	Pin Number	15-Pin Side of the Signal Cable
1	Video-Red	9	+5V
2	Video-Green	10	Ground
3	Video-Blue	11	N.C.
4	N.C.	12	DDC-Serial data
5	Detect Cable	13	H-sync
6	GND-R	14	V-sync
7	GND-G	15	DDC-Serial clock
8	GND-B		



Pin No.	Signal Name	Pin No.	Signal Name	Pin No.	Signal Name
1.	TMDS Data 2+	9.	TMDS Data 0-	17.	DDC/CEC Ground
2.	TMDS Data 2 Shield	10.	TMDS Clock +	18.	+5V Power
3.	TMDS Data 2-	11.	TMDS Clock Shield	19.	Hot Plug Detect
4.	TMDS Data 1+	12.	TMDS Clock-		
5.	TMDS Data 1Shield	13.	CEC		
6.	TMDS Data 1-	14.	Reserved (N.C. on device)		
7.	TMDS Data 0+	15.	SCL		
8.	TMDS Data 0 Shield	16.	SDA		

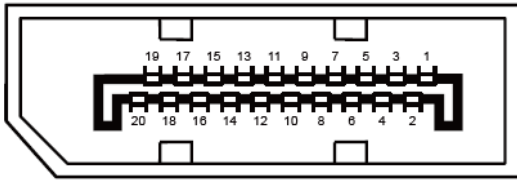

20-Pin Color Display Signal Cable

Pin No.	Signal Name	Pin No.	Signal Name
1	ML_Lane 3 (n)	11	GND
2	GND	12	ML_Lane 0 (p)
3	ML_Lane 3 (p)	13	CONFIG1
4	ML_Lane 2 (n)	14	CONFIG2
5	GND	15	AUX_CH(p)
6	ML_Lane 2 (p)	16	GND
7	ML_Lane 1 (n)	17	AUX_CH(n)
8	GND	18	Hot Plug Detect
9	ML_Lane 1 (p)	19	Return DP_PWR
10	ML_Lane 0 (n)	20	DP_PWR

Plug and Play

Plug & Play DDC2B Feature

This monitor is equipped with VESA DDC2B capabilities according to the VESA DDC STANDARD. It allows the monitor to inform the host system of its identity and, depending on the level of DDC used, communicate additional information about its display capabilities.

The DDC2B is a bi-directional data channel based on the I2C protocol. The host can request EDID information over the DDC2B channel.

WEEE Declaration

Disposal of Waste Equipment by Users in Private Household in the European Union.



This symbol on the product or on its packaging indicates that this product must not be disposed of with your other household waste. Instead, it is your responsibility to dispose of your waste equipment by handing it over to a designated collection point for the recycling of waste electrical and electronic equipment. The separate collection and recycling of your waste equipment at the time of disposal will help to conserve natural resources and ensure that it is recycled in a manner that protects human health and the environment. For more information about where you can drop off your waste equipment for recycling, please contact your local city office, your household waste disposal service or the shop where you purchased the product.

Regulation

FCC Notice

FCC Class B Radio Frequency Interference Statement WARNING: (FOR FCC CERTIFIED MODELS)

NOTE: This equipment has been tested and found to comply with the limits for a Class B digital device, pursuant to Part 15 of the FCC Rules. These limits are designed to provide reasonable protection against harmful interference in a residential installation. This equipment generates, uses and can radiate radio frequency energy, and if not installed and used in accordance with the instructions, may cause harmful interference to radio communications. However, there is no guarantee that interference will not occur in a particular installation. If this equipment does cause harmful interference to radio or television reception, which can be determined by turning the equipment off and on, the user is encouraged to try to correct the interference by one or more of the following measures:

Reorient or relocate the receiving antenna.

Increase the separation between the equipment and receiver.

Connect the equipment into an outlet on a circuit different from that to which the receiver is connected.

Consult the dealer or an experienced radio/TV technician for help.

NOTICE:

The changes or modifications not expressly approved by the party responsible for compliance could void the user's authority to operate the equipment.

Shielded interface cables and AC power cord, if any, must be used in order to comply with the emission limits.

The manufacturer is not responsible for any radio or TV interference caused by unauthorized modification to this equipment. It is the responsibilities of the user to correct such interference. It is the responsibility of the user to correct such interference.

This device complies with Part 15 of the FCC Rules. Operation is subject to the following two conditions: (1) this device may not cause harmful interference, and (2) this device must accept any interference received, including interference that may cause undesired operation.

Restriction on Hazardous Substances statement (India)

This product complies with the "E-Waste (Management) Rules, 2016" CHAPTER V, rule 16, sub-rule (1) . Whereas New Electrical and Electronic Equipment and their components or consumables or parts or spares do not contain Lead, Mercury, Cadmium, Hexavalent Chromium, polybrominated biphenyls and polybrominated diphenyl ethers beyond a maximum concentration value of 0.1% by weight in homogenous materials for lead, mercury, hexavalent chromium, polybrominated biphenyls and polybrominated diphenyl ethers and of 0.01% by weight in homogenous materials for cadmium. except of exemptions set in Schedule 2 of the Rule.

E-Waste Declaration for India



This symbol on the product or on its packaging indicates that this product must not be disposed of with your other household waste. Instead it is your responsibility to dispose of your waste equipment by handing it over to a designated collection point for the recycling of waste electrical and electronic equipment .The separate collection and recycling of your waste equipment at the time of disposal will help to conserve natural resources and ensure that it is recycled in a manner that protects human health and the environment. For more information about E -waste please visit <http://www.aocindia.com/ewaste.php> and to know where you can drop off your waste equipment for recycling in India please contact on below given contact details.

Helpline number: 080-6788-6788 / 080-3323-1313 (Monday to Saturday, 10 a.m. to 6 p.m.)

Centralized E-waste collection center

Address: TPV Technology India Private Limited, 59, Maheswari Nagar, 1st Main Road,

Mahadevapura Post,Whitefield Road,Bangalore,Karnataka,PIN:560048,

Tel: 080-6788-6799

E-mail: serviceindia@aoc.com

Service

Warranty Statement for Europe

LIMITED THREE-YEAR WARRANTY*

For AOC LCD Monitors sold within Europe, AOC International (Europe) B.V. warrants this product to be free from defects in material and workmanship for a period of Three (3) years after the original date of consumer purchase. During this period, AOC International (Europe) B.V. will, at its option, either repair the defective product with new or rebuilt parts, or replace it with a new or rebuilt product at no charge except as *stated below. In the absence of the proof of purchase, the warranty will start 3 months after the date of manufacturing indicated on the product.

If the product appears to be defective, please contact your local dealer or refer to the service and support section on www.aoc-europe.com for the warranty instructions in your country. The freight cost for the warranty is pre-paid by AOC for the delivery and return. Please ensure you provide a dated proof of purchase along with the product and deliver to the AOC Certified or Authorized Service Center under the following condition:

- Make sure the LCD Monitor is packed in a proper carton box (AOC prefers the original carton box to protect your monitor well enough during transport).
- Put the RMA number on the address label
- Put the RMA number on the shipping carton

AOC International (Europe) B.V. will pay the return shipping charges within one of the countries specified within this warranty statement. AOC International (Europe) B.V. is not responsible for any costs associated with the transportation of product across international borders. This includes the international border within the European Union. If the LCD Monitor is not available for collection when the carrier attends, you will be charged a collection fee.

*** This limited warranty does not cover any losses or damages that occur as a result of:**

- Damages during transport due to improper packaging
- Improper installation or maintenance other than in accordance with AOC's user manual
- Misuse
- Neglect
- Any cause other than ordinary commercial or industrial application
- Adjustment by non-authorized source
- Repair, modification, or installation of options or parts by anyone other than an AOC Certified or Authorized Service Center
- Improper environments like humidity, water damage and dusts
- Damaged by violence, earthquake and terrorist attacks
- Excessive or inadequate heating or air conditioning or electrical power failures, surges, or other irregularities

This limited warranty does not cover any of the product firmware or hardware that you or any third party have modified or altered; you bear the sole responsibility and liability for any such modifications or alteration.

All AOC LCD Monitors are produced according to the ISO 9241-307 Class 1 pixel policy standards.

If your warranty has expired, you still have access to all available service options, but you will be responsible for the cost of service, including parts, labor, shipping (if any) and applicable taxes. AOC Certified or Authorized Service Center will provide you with an estimate of service costs before receiving your authorization to perform service.

ALL EXPRESS AND IMPLIED WARRANTIES FOR THIS PRODUCT (INCLUDING THE WARRANTIES OF MERCHANTABILITY AND FITNESS FOR A PARTICULAR PURPOSE) ARE LIMITED IN DURATION TO A PERIOD OF THREE (3) YEARS FOR PARTS AND LABOR FROM THE ORIGINAL DATE OF CONSUMER PURCHASE. NO WARRANTIES (EITHER EXPRESSED OR IMPLIED) APPLY AFTER THIS PERIOD. AOC INTERNATIONAL (EUROPE) B.V. OBLIGATIONS AND YOUR REMEDIES HEREUNDER ARE SOLELY AND EXCLUSIVELY AS STATED HERE. AOC INTERNATIONAL (EUROPE) B.V. LIABILITY, WHETHER BASED ON CONTRACT, TORT, WARRANTY, STRICT LIABILITY, OR OTHER THEORY, SHALL NOT EXCEED THE PRICE OF THE INDIVIDUAL UNIT WHOSE DEFECT OR DAMAGE IS THE BASIS OF THE CLAIM. IN NO EVENT SHALL AOC INTERNATIONAL (EUROPE) B.V. BE LIABLE FOR ANY LOSS OF PROFITS, LOSS OF USE OR FACILITIES OR EQUIPMENT, OR OTHER INDIRECT, INCIDENTAL, OR CONSEQUENTIAL DAMAGE. SOME STATES DO NOT ALLOW THE EXCLUSION OR LIMITATION OF INCIDENTAL OR CONSEQUENTIAL DAMAGES, SO THE ABOVE LIMITATION MAY NOT APPLY TO YOU. ALTHOUGH THIS LIMITED WARRANTY GIVES YOU SPECIFIC LEGAL RIGHTS, YOU MAY HAVE OTHER RIGHTS, WHICH MAY VARY FROM COUNTRY TO COUNTRY. THIS LIMITED WARRANTY IS ONLY VALID FOR PRODUCTS PURCHASED IN THE MEMBER COUNTRIES OF THE EUROPEAN UNION.

Information in this document is subject to change without notice. For more information, please visit:

<http://www.aoc-europe.com>

Warranty Statement for Middle East and Africa (MEA)

And

The Commonwealth of Independent States (CIS)

LIMITED ONE to THREE YEARS WARRANTY*

For AOC LCD Monitors sold within the Middle East and Africa (MEA) and the Commonwealth of Independent States (CIS), AOC International (Europe) B.V. warrants this product to be free from defects in material and workmanship for a period of One (1) to Three (3) years from the manufacture date depending on sale country. During this period, AOC International (Europe) B.V. offers a Carry-In (return to Service Center) Warranty Support at an AOC's Authorized Service Center or Dealer and at its option, either repair the defective product with new or rebuilt parts, or replace it with a new or rebuilt product at no charge except as *stated below. As a Standard Policy, the warranty will be calculated from the manufacture date identified from the product ID serial number, but the total warranty will be Fifteen (15) months to Thirty Nine (39) months from MFD (manufacture date) depending on sale country. Warranty will be considered for exceptional cases that are out of warranty as per the product ID serial number and for such exceptional cases; Original Invoice/Proof Of Purchase Receipt is mandatory.

If the product appears to be defective, please contact your AOC authorized dealer or refer to the service and support section on AOC's website for the warranty instructions in your country:

- Egypt: http://aocmonitorap.com/egypt_eng
- CIS Central Asia: <http://aocmonitorap.com/ciscentral>
- Middle East: <http://aocmonitorap.com/middleeast>
- South Africa: <http://aocmonitorap.com/southafrica>
- Saudi Arabia: <http://aocmonitorap.com/saudiarabia>

Please ensure you provide a dated proof of purchase along with the product and deliver to the AOC Authorized Service Center or Dealer under the following condition:

- Make sure the LCD Monitor is packed in a proper carton box (AOC prefers the original carton box to protect your monitor well enough during transport).
- Put the RMA number on the address label
- Put the RMA number on the shipping carton

*** This limited warranty does not cover any losses or damages that occur as a result of:**

- Damages during transport due to improper packaging
- Improper installation or maintenance other than in accordance with AOC's user manual
- Misuse
- Neglect
- Any cause other than ordinary commercial or industrial application
- Adjustment by non-authorized source
- Repair, modification, or installation of options or parts by anyone other than an AOC Certified or

Authorized Service Center

- Improper environments like humidity, water damage and dusts
- Damaged by violence, earthquakes and terrorist attacks
- Excessive or inadequate heating or air conditioning or electrical powers failures, surges, or other irregularities

This limited warranty does not cover any of the product firmware or hardware that you or any third party have modified or altered; you bear the sole responsibility and liability for any such modifications or alteration.

All AOC LCD Monitors are produced according to the ISO 9241-307 Class 1 pixel policy standards.

If your warranty has expired, you still have access to all available service options, but you will be responsible for the cost of service, including parts, labor, shipping (if any) and applicable taxes. AOC Certified, Authorized Service Center or dealer will provide you with an estimate of service costs before receiving your authorization to perform service.

ALL EXPRESS AND IMPLIED WARRANTIES FOR THIS PRODUCT (INCLUDING THE WARRANTIES OF MERCHANTABILITY AND FITNESS FOR A PARTICULAR PURPOSE) ARE LIMITED IN DURATION TO A PERIOD OF ONE (1) to THREE (3) YEARS FOR PARTS AND LABOR FROM THE ORIGINAL DATE OF CONSUMER PURCHASE. NO WARRANTIES (EITHER EXPRESSED OR IMPLIED) APPLY AFTER THIS PERIOD. AOC INTERNATIONAL (EUROPE) B.V. OBLIGATIONS AND YOUR REMEDIES HEREUNDER ARE SOLELY AND EXCLUSIVELY AS STATED HERE. AOC INTERNATIONAL (EUROPE) B.V. LIABILITY, WHETHER BASED ON CONTRACT, TORT, WARRANTY, STRICT LIABILITY, OR OTHER THEORY, SHALL NOT EXCEED THE PRICE OF THE INDIVIDUAL UNIT WHOSE DEFECT OR DAMAGE IS THE BASIS OF THE CLAIM. IN NO EVENT SHALL AOC INTERNATIONAL (EUROPE) B.V. BE LIABLE FOR ANY LOSS OF PROFITS, LOSS OF USE OR FACILITIES OR EQUIPMENT, OR OTHER INDIRECT, INCIDENTAL, OR CONSEQUENTIAL DAMAGE. SOME STATES DO NOT ALLOW THE EXCLUSION OR LIMITATION OF INCIDENTAL OR CONSEQUENTIAL DAMAGES, SO THE ABOVE LIMITATION MAY NOT APPLY TO YOU. ALTHOUGH THIS LIMITED WARRANTY GIVES YOU SPECIFIC LEGAL RIGHTS, YOU MAY HAVE OTHER RIGHTS, WHICH MAY VARY FROM COUNTRY TO COUNTRY. THIS LIMITED WARRANTY IS ONLY VALID FOR PRODUCTS PURCHASED IN THE MEMBER COUNTRIES OF THE EUROPEAN UNION.

Information in this document is subject to change without notice. For more information, please visit:

<http://www.aocmonitorap.com>

AOC PIXEL POLICY

ISO 9241-307 CLASS 1

July 25th, 2013

AOC strives to deliver the highest quality products. We use some of the industry's most advanced manufacturing processes and practice stringent quality control. However, pixel or sub pixel defects on the TFT monitor panels used in flat panel monitors are sometimes unavoidable. No manufacturer can guarantee that all panels will be free from pixel defects, but AOC guarantees that any monitor with an unacceptable number of defects will be repaired or replaced under warranty. This Pixel Policy explains the different types of pixel defects and defines acceptable defect levels for each type. In order to qualify for repair or replacement under warranty, the number of pixel defects on a TFT monitor panel must exceed these acceptable levels.

Pixels and Sub Pixel Definition

A pixel, or picture element, is composed of three sub pixels in the primary colors of red, green and blue. When all sub pixels of pixel are lit, the three colored sub pixel together appear as a single white pixel. When all are dark, the three colored sub pixels together appear as a single black pixel.

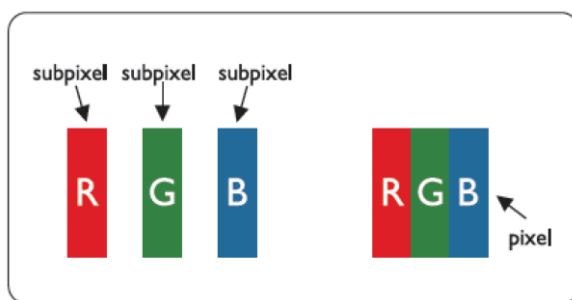

Types of Pixel Defects

- Bright Dot Defects: the monitor displays a dark pattern, sub pixels or pixels are always lit or "on"
- Black Dot Defects: the monitor displays a light pattern, sub pixels or pixels are always dark or "off".

ISO 9241-307 Pixel Defect Class	Defect Type 1Bright Pixel	Defect Type 2 Black Pixel	Defect Type 3 Bright Sub pixel	Defect Type 4 Black Sub pixel
Classe 1	1	1	2 1 0	+ + +
				1 3 5

Warranty Statement for North & South America (excluding Brazil)

WARRANTY STATEMENT

For AOC Color Monitors

Including those Sold within North America as Specified

Envision Peripherals, Inc. warrants this product to be free from defects in material and workmanship for a period of three (3) years for parts & labor, one (1) year for the LCD panel, after the original date of consumer purchase. During this period, EPI (Envision Peripherals, Inc.) will, at its discretion, either repair the defective product with new or rebuilt parts, or replace it with a new or rebuilt product at no charge except as stated below.* The parts or product that are replaced become the property of EPI.

In the USA, to obtain service under this limited warranty first call EPI for the name of the Authorized Service Center closest to your area. Then deliver the product freight pre-paid, along with the dated proof of purchase, to the EPI Authorized Service Center. If you cannot deliver the product in person, please ship the product using the following guidelines:

- Pack it in its original shipping container (or equivalent)
- Put the RMA number on the address label
- Put the RMA number on the shipping carton
- Insure it (or assume the risk of loss / damage during shipment)
- Pay all shipping charges

EPI is not responsible for damage to inbound product that were not properly packaged. EPI will pay the return shipping charges within one of the countries specified within this warranty statement. EPI is not responsible for any costs associated with the transportation of product across international borders. This includes the international borders of the countries within this warranty statement.

In the United States and Canada contact your Dealer or EPI Customer Service, RMA Department at the toll free number (888) 838-6388. Or you can request an RMA Number online at http://us.aoc.com/contact_support.php.

*This limited warranty does not cover any losses or damages that occur as a result of:

- Any cause other than ordinary commercial or industrial application
- Repair, adjustment, modification, or installation of options or parts by anyone other than an EPI Authorized Service Center
- Storage or use in improper environments including excessive or inadequate heating or cooling
- Electrical power failures, surges, or other electrical irregularities
- Shipping damage from store to end user or from end user to AOC authorized service center
- Improper handling or installation
- Acts of God, fire, earthquake, accident, or other unintentional activities
- Product Scratches, cosmetic damage, panel cell crack, or other physical damage

Furthermore, this limited warranty does not cover any losses or damages under the following conditions:

- Product has been opened by anyone other than an EPI Authorized Service Center
- Product was purchased from any party other than an authorized reseller
- The date on proof of purchase receipt is invalid
- Product is out of warranty period

This three-year limited warranty does not cover any of the product's firmware or hardware that you or any third party have modified or altered; you bear the sole responsibility and liability for any such modification or alteration.

ALL EXPRESS AND IMPLIED WARRANTIES FOR THIS PRODUCT (INCLUDING THE WARRANTIES OF MERCHANTABILITY AND FITNESS FOR A PARTICULAR PURPOSE) ARE LIMITED IN DURATION TO A PERIOD OF THREE (3) YEARS FOR PARTS AND LABOR AND ONE (1) YEAR FOR LCD PANEL FROM THE ORIGINAL DATE OF CONSUMER PURCHASE. NO WARRANTIES (EITHER EXPRESSED OR IMPLIED) APPLY AFTER THIS PERIOD. IN THE UNITED STATES OF AMERICA, SOME STATES DO NOT ALLOW LIMITATIONS ON HOW LONG AN IMPLIED

WARRANTY LASTS, SO THE ABOVE LIMITATIONS MAY NOT APPLY TO YOU.

EPI OBLIGATIONS AND YOUR REMEDIES HEREUNDER ARE SOLELY AND EXCLUSIVELY AS STATED HERE. EPI LIABILITY, WHETHER BASED ON CONTRACT, TORT, WARRANTY, STRICT LIABILITY, OR OTHER THEORY, SHALL NOT EXCEED THE PRICE OF THE INDIVIDUAL UNIT WHOSE DEFECT OR DAMAGE IS THE BASIS OF THE CLAIM. IN NO EVENT SHALL ENVISION PERIPHERALS, INC. BE LIABLE FOR ANY LOSS OF PROFITS, LOSS OF USE OR FACILITIES OR EQUIPMENT OR OTHER INDIRECT, INCIDENTAL, OR CONSEQUENTIAL DAMAGE. IN THE UNITED STATES OF AMERICA, SOME STATES DO NOT ALLOW THE EXCLUSION OR LIMITATION OF INCIDENTAL OR CONSEQUENTIAL DAMAGES. SO THE ABOVE LIMITATION MAY NOT APPLY TO YOU. ALTHOUGH THIS LIMITED WARRANTY GIVES YOU SPECIFIC LEGAL RIGHTS. YOU MAY HAVE OTHER RIGHTS WHICH MAY VARY FROM STATE TO STATE.

In the United States of America, this limited warranty is only valid for Products purchased in the Continental United States, Alaska, and Hawaii. Outside the United States of America, this limited warranty is only valid for Products purchased in Canada. For Service in South America, refer to the SA Service Center List included with the product.

Warranty Statement for India

Thank you for choosing AOC. We realize that you had other options and chose to trust AOC. We will try our best to live up to our promises and exceed your expectations.

TPV India Technology India Pvt. Ltd. warrants this product to be free from defects in material and workmanship for a period of three years from the date of purchase.

Our products are designed and manufactured to avoid any defects. But if something goes wrong, we are prepared to take care of the inconvenience it would cause you. In life, things do go wrong. But what matters is how we handle those failures.

How you could register a new service request?

Please write to us with your product details like model number, serial number, the problem you face and your address and contact numbers.

Email:

serviceindia@aoc.co

m

Else you could also call us on our helpline numbers given below:

080-6788-6788 or 080-3323-1313 (10 a.m. and 6 p.m., Mondays to Saturdays except public holidays)

You could also send a text message 'AOC' to **56677** and we would call you back within 4 working hours.

How are we prepared to serve you?

We keep our spare parts ready and near to you, to minimize any delay in providing repair services. We have most of our spare parts kept in following cities to take care of customers in respective or nearby states.

North India: Delhi, Lucknow, Chandigarh and Jaipur

East India: Kolkata, Guwahati, Bhubaneswar and Patna

West India: Mumbai, Ahmedabad, Indore and Raipur

South India: Chennai, Bangalore, Hyderabad and Cochin

If a service request is registered through our contact center by 12 p.m., we would dispatch the spare part required (based on the problem reported by you) on the same day, to our authorized service center near to you. Within few days (depending on distance from your place to our service center) of delivery of spare part at a service center, our technician would visit your place and try to resolve the problem. There are rare chances that some of the parts are readily not available at our regional warehouses mentioned above, or another spare part is required to be dispatched from our central spare parts warehouse at Bangalore. Such cases would require an additional time in resolution of service request.

What is the warranty period for your AOC monitor?

The standard warranty period for AOC monitors is three years from the date you purchased. While our technician visits your place, the invoice needs to be presented. If you are unable to show the invoice, it would be considered that the product is not under the warranty period and hence the visit charges, depending on the distance from our authorized service center to your place, need to be paid to our technician. Also, if any spare part is used for repair, the corresponding cost also need to be paid.

What are the terms and conditions of the warranty?

1. Warranty is confined to the first purchaser of the product and is non-transferable.
2. Warranty is applicable only on producing the purchase tax invoice which mentions the product name and serial number.
3. During the warranty period, the product will only be repaired by replacing the parts. Entire unit replacement may be done in such a scenario where there are no spares available / model is discontinued.
4. In case the replacement of the entire unit is being made (subject to the sole discretion of the Company), the same model shall be replaced and in the event such model has been discontinued, it shall be replaced with a model equivalent as deemed by the Company. The warranty on replacement model shall remain in force only for the unexpired period of the warranty based on original purchase tax invoice.
5. In the event of repairs/replacement of any part/s of the unit, this warranty will thereafter continue and remain in force only for the unexpired period of the warranty. Moreover, the time taken for repair/replacement and in transit whether under the warranty or otherwise shall not be excluded from the warranty period.
6. The company or its authorized service center, reserves the right to retain any part/s or component/s replaced at its discretion in the event of a defect noticed in the equipment during the warranty period. The part/s or component/s or unit/s replaced will become the property of the company.
7. The company's obligation under this warranty shall be limited to repair or providing replacement of part/s only. This warranty shall not cover any consequential or resulting liability, damage or loss to property or life arising directly or indirectly out of any defect in the product. The maximum claim/s if entertained by the company will be subject to the maximum retail price of the product purchased or amount mentioned in the purchase invoice, whichever is lower.
8. In the event of any unforeseen circumstance, and spares not being available, the company's prevailing depreciation rules will be binding on the purchaser to accept as a commercial solution in lieu of repairs.
9. The warranty does not cover any accessories external to the equipment like the cables, remote control, batteries, base / stand, adaptors, 3D glasses, clip-on glasses, etc.
10. The warranty will automatically terminate on the expiry of the warranty period, even if the product may not be in use for any time during the warranty period for any reason.

What is not covered under the standard warranty?

The standard warranty is not applicable

1. If the serial number of the product is tampered
2. If any unauthorized person has opened the product or tried for repairs
3. If the original purchase invoice is not shown to the authorized technician upon request.
4. If the defect is caused due to high humid environment or the product is not used according to the instructions given in user manual.
5. If the defects are caused due to improper use or handling of the product as determined by our authorized technician/ representative.
6. If the defects are caused due to reasons beyond our control like lightening, fire, abnormal voltage spike, electrical short circuit, improper grounding, floods, earthquakes, terrorism or any act of God
7. For defects caused due to normal wear and tear such as scratches on the body of the product, colour fading etc.
8. For any user induced damages, physical damages, damages to the liquid crystals on the panel, defects caused due to liquid spillage such as air bubbles (commonly called as black spot on screen), patches or mura effect due to uneven external pressure on the panel, dust inside the panel, defects arising due to modification or alteration of any nature made in the electrical circuitry or physical construction of the product.
9. For pixel defects within acceptable levels. Up to 3 bright pixels (dots) or up to 3 dark pixels or a combination of 5 pixels is not considered as a defect.

Note: Any dispute related to warranty of the product is subjected to exclusive jurisdiction of the courts at New Delhi.

How to clean the monitor?

Turn off the monitor first. Gently wipe away any dust on the computer monitor using a very soft cloth. Wipe the flat screen as softly as possible, starting at one side and swiping straight across. Do not rub the flat screen in a circular or up and down motion, as this could scratch the flat screen. Do not try to wipe away any streaks, spots or grime with the dry cloth either. The purpose of this step is simply to wipe off as much dust as possible.

When you are done dusting, moisten a special cleaning cloth or tool, or another clean, soft cloth with special liquid cleaner for flat screens, distilled water, or a mixture of white vinegar and distilled water. Do not spray or pour any type of cleaner directly onto the computer monitor. Doing so could cause the liquid to drip down inside of the flat screen, causing irreparable damage. Instead, spray the cleaner onto the cloth or dip the cloth into the liquid. Again, try not to press too hard on the flat screen as you clean it. Pressing into the screen can cause permanent damage. Wipe the dampened cloth gently from side to side or from top to bottom. Make sure the computer monitor is completely dry before you turn it back on.

When the liquid drips down/ gets accumulated near the sides/ corners, it causes the metal frame of the LCD panel to corrode thereby causing gaps through which air rushes inside the two glass plates inside the panel. This makes crystals of the LCD (Liquid Crystal Display – Crystals with some electric properties floating in a liquid medium) to dislocate and appear to us as air bubbles (or black spots as commonly called) inside the panel. Such defects are not covered under the standard warranty.

Our services haven't met your expectations? Share your feedback to our Service Head

If we haven't been able to meet your expectations or you would like share a feedback or suggestion to our Service Head, please write an email to india@aoc-support.com. If your feedback is related to a service request, please mention the 12 digit Service Job Number in your email.

EASE PROGRAM



Only for AOC branded monitors sold within the continental United States.

All AOC branded monitors are now covered by the EASE Program. If your monitor malfunctions at any time during the first three months, AOC will provide a replacement monitor within 72 hours after you are approved for our program. If your monitor qualifies for the EASE program, AOC will pay for freight both ways.

Step 1: Phone our TECH Department at 888.662.9888

Step 2: Fill out and return EASE registration forms by mail or fax.

Step 3: We will issue a Return Authorization Number upon verification into the program.

Step 4: A monitor will be advance shipped to your location.

Step 5: We will issue a UPS Call Tag to pick up the defective unit.

Step 6: Please review the following chart to see your EASE program qualifications.

WARRANTY PERIOD	COVERAGE AT NO CHARGE	CUSTOMER CHARGES
Within the first three months of purchase: Covered by EASE	- New AOC monitor - Call tag dispatched and return freightcharges via UPS	- None*
Between 4 months – 1 Year	- All Parts & Labor Including CRT Tube & LCD Panel	- UPS Return Freight to AOC
Between 1 Year - 3 Years: Covered by standard limited warranty	- Parts & Labor (excluding CRT Tube & LCD Panel)	- UPS Return Freight to AOC

*AOC will need to obtain a credit card number if you would like to get a new AOC monitor advanced shipped to your location, prior to the defective unit arriving at AOC's service center. If you do not wish to supply a credit card, AOC will only ship the new monitor, once the defective unit arrives at the AOC service center.

